

In the Matter of

**CERTAIN NETWORK DEVICES RELATED
SOFTWARE AND COMPONENTS THEREOF
(II)**

337-TA-945

Publication 4910

June 2019

U.S. International Trade Commission

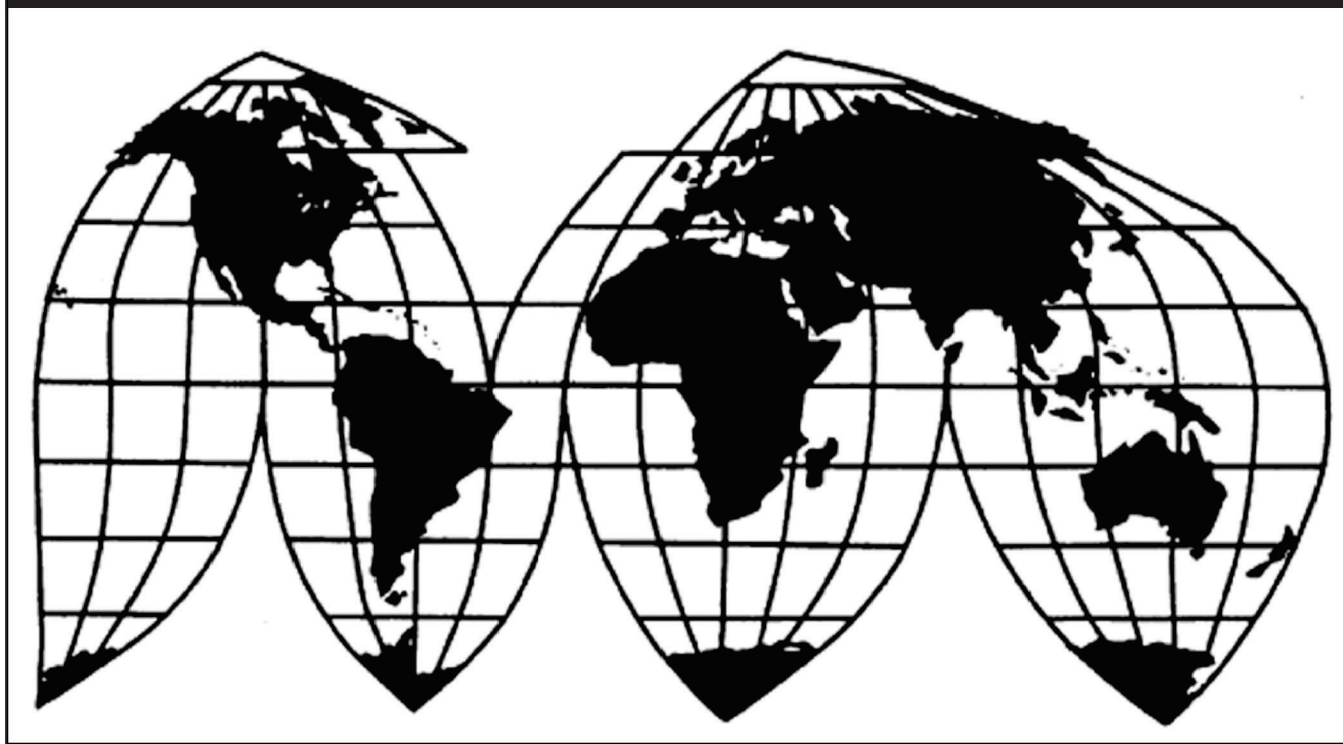

Washington, DC 20436

U.S. International Trade Commission

COMMISSIONERS

David Johanson, Chairman
Irving Williamson, Commissioner
Meredith Broadbent, Commissioner
Rhonda Schmidlein, Commissioner
Jason Kearns, Commissioner

**Address all communications to
Secretary to the Commission
United States International Trade Commission
Washington, DC 20436**

U.S. International Trade Commission

Washington, DC 20436
www.usitc.gov

In the Matter of

CERTAIN NETWORK DEVICES RELATED SOFTWARE AND COMPONENTS THEREOF (II)

337-TA-945



**UNITED STATES INTERNATIONAL TRADE COMMISSION
Washington, D.C.**

In the Matter of

**CERTAIN NETWORK DEVICES,
RELATED SOFTWARE AND
COMPONENTS THEREOF (II)**

**Investigation No. 337-TA-945
(Modification 2)**

**GRANT OF JOINT MOTION TO TERMINATE THE MODIFICATION PROCEEDING
BASED ON A SETTLEMENT AGREEMENT;
TERMINATION OF THE MODIFICATION PROCEEDING IN ITS ENTIRETY**

AGENCY: U.S. International Trade Commission.

ACTION: Notice.

SUMMARY: Notice is hereby given that the U.S. International Trade Commission has determined grant a joint motion of complainant Cisco Systems, Inc. of San Jose, California (“Cisco”) and respondent Arista Networks, Inc. of Santa Clara, California (“Arista”) to terminate the above-captioned modification proceeding concerning a limited exclusion order and a cease and desist order issued against Arista in Inv. No. 337-TA-945. The modification proceeding is terminated in its entirety.

FOR FURTHER INFORMATION CONTACT: Megan M. Valentine, Office of the General Counsel, U.S. International Trade Commission, 500 E Street, S.W., Washington, D.C. 20436, telephone (202) 708-2301. Copies of non-confidential documents filed in connection with this investigation are or will be available for inspection during official business hours (8:45 a.m. to 5:15 p.m.) in the Office of the Secretary, U.S. International Trade Commission, 500 E Street, S.W., Washington, D.C. 20436, telephone (202) 205-2000. General information concerning the Commission may also be obtained by accessing its Internet server at <https://www.usitc.gov>. The public record for this investigation may be viewed on the Commission’s electronic docket (EDIS) at <https://edis.usitc.gov>. Hearing-impaired persons are advised that information on this matter can be obtained by contacting the Commission’s TDD terminal on (202) 205-1810.

SUPPLEMENTARY INFORMATION: The Commission instituted this investigation on January 27, 2015, based on a Complaint filed by Cisco. 80 FR 4313-14 (Jan. 27, 2015). The Complaint alleges violations of section 337 of the Tariff Act of 1930, as amended, 19 U.S.C. § 1337 (“section 337”), by reason of infringement of certain claims of U.S. Patent Nos. 7,023,853 (“the ’853 patent”); 6,377,577 (“the ’577 patent”); 7,460,492 (“the ’492 patent”); 7,061,875 (“the ’875 patent”); 7,224,668 (“the ’668 patent”); and 8,051,211 (“the ’211 patent”). The Complaint further alleges the existence of a domestic industry. The Commission’s Notice of Investigation named Arista as the respondent. The Office of Unfair Import Investigations (“OUII”) was also named as a party to the investigation. The Commission terminated the

investigation in part as to certain claims of the asserted patents. Notice (Nov. 18, 2015) (see Order No. 38 (Oct. 27, 2015)); Notice (Dec. 1, 2015) (see Order No. 47 (Nov. 9, 2015)).

On June 11, 2016, the Patent Trial and Appeal Board (“PTAB”) of the U.S. Patent and Trademark Office instituted separate *inter partes* review (“IPR”) proceedings concerning the ’577 and ’668 patents. *Arista Networks, Inc. v. Cisco Systems, Inc.*, Case IPR2016-00303 (regarding the ’577 patent); *Arista Networks, Inc. v. Cisco Systems, Inc.*, Case IPR2016-00309 (regarding the ’668 patent).

On May 4, 2017, the Commission found a violation of section 337 with respect to certain of the asserted claims of the ’577 and ’668 patents. Notice (May 4, 2017); 82 FR 21827-29 (May 10, 2017); *see also* Notice of Correction (May 30, 2017); 82 FR 25811 (June 5, 2017). The Commission issued a limited exclusion order (“LEO”) and a cease and desist order (“CDO”) against Arista. *Id.* The Commission did not find a violation with respect to the ’853, ’875, ’492, and ’211 patents. *Id.*

On May 25, 2017, the PTAB issued its final written decision finding certain claims of the ’577 patent unpatentable based on prior art not presented in the Commission investigation. On June 1, 2017, the PTAB issued its final written decision finding certain claims of the ’668 patent unpatentable based on certain combinations of prior art not presented in the Commission investigation. Both decisions affected the claims upon which the Commission found a violation of section 337.

On June 30, 2017, Cisco filed a notice of appeal with the United States Court of Appeals for the Federal Circuit (“Federal Circuit”), seeking review of the Commission’s finding of no violation as to the ’853, ’875, ’492, and ’211 patents. *Cisco Sys., Inc. v. Int’l Trade Comm’n*, Appeal No. 17-2289. On July 21, 2017, Arista filed a notice of appeal with the Federal Circuit, seeking review of the Commission’s finding of violation as to the ’577 and ’668 patents. *Arista Networks, Inc. v. Int’l Trade Comm’n*, Appeal No. 17-2336. On August 3, 2017, the Federal Circuit consolidated the Arista and Cisco appeals. *Cisco Sys., Inc. v. Int’l Trade Comm’n*, Appeal No. 17-2289, Dkt. No. 20.

On August 25, 2017, Arista filed a motion with the Federal Circuit seeking to stay the Commission’s remedial orders pending resolution of the appeal on the merits. On September 22, 2017, the Federal Circuit denied this request “subject to the condition that the product redesign on which Cisco relies to deny irreparable harm must be permitted to enter the country, without being blocked by the Commission order under review in this case, unless and until Commission proceedings are initiated and completed to produce an enforceable determination that such a redesign is barred by the order here under review or by a new or amended order.” *Cisco Sys, Inc. v. ITC; Arista Networks, Inc. v. ITC*, Appeal Nos. 2017-2289, -2351, Order at 3 (Fed. Cir. Sept. 22, 2017).

On September 27, 2017, Cisco petitioned for a modification proceeding to determine whether Arista’s redesigned switches infringe the patent claims that are the subject of the LEO and CDO issued in this investigation and for modification of the remedial orders to specify the status of these redesigned products.

On November 1, 2017, the Commission instituted the modification proceeding. 82 FR 50678 (Nov. 1, 2017). On November 7, 2018, the Commission issued a notice clarifying that OUII is not named as a party in the modification proceeding. 82 FR 52318 (Nov. 13, 2017).

On February 14, 2018, the Federal Circuit summarily affirmed the PTAB's decision finding the claims of the '668 patent unpatentable. *Cisco Systems, Inc. v. Arista Networks, Inc.*, Appeal No. 17-2384, Order (Feb. 14, 2018). The Court issued the mandate on March 23, 2018. *Id.*, Dkt. No. 54.

On March 23, 2018, the ALJ issued a recommended determination in the modification proceeding ("MRD"), finding that Arista's redesigned products infringe the relevant claims of the '668 patent but do not infringe the relevant claims of the '577 patent. MRD (Mar. 23, 2018). Also on March 23, 2018, the ALJ issued an order denying Arista's motion to stay the modification proceedings or to stay the remedial orders with respect to the '668 patent. Order No. 20 (Mar. 23, 2018).

On April 5, 2018, the Commission determined to modify the remedial orders to suspend enforcement of those orders with respect to the '668 patent. Notice (Apr. 5, 2018); Comm'n Order (Apr. 5, 2018).

On June 26, 2018, the Commission accepted the ALJ's recommended determination finding no infringement with respect to the '577 patent and determined to modify the remedial orders to exempt Arista's redesigned products that were the subject of the modification proceeding. The Commission also determined to suspend the modification proceeding as to the '668 patent. The '577 patent expired on June 30, 2018.

On August 27, 2018, the Federal Circuit granted a motion of the parties to voluntarily dismiss the consolidated appeal from the Commission's final determination on violation. *Cisco Sys., Inc.*, Appeal No. 17-2289, Dkt. No. 121 (Aug. 27, 2018).

On August 27, 2018, Cisco and Arista filed a joint motion to terminate the modification proceeding in its entirety pursuant to Commission Rule 210.21(b)(1) (19 CFR 210.21(b)(1)) based on a settlement agreement between the parties. The motion indicates that the Agreement fully resolves the disputed issues in the modification proceeding, that there are no other agreements, written or oral, express or implied, between them concerning the subject matter of this proceeding, and that the motion includes a public version of this Motion along with an accompanying public version of the Agreement. The motion also contends that termination of the modification proceeding will not adversely affect the public interest.

The Commission has determined to grant the joint motion and terminate the modification proceeding in its entirety. We note that only the '668 patent remains in the modification proceeding.

The authority for the Commission's determination is contained in section 337 of the Tariff Act of 1930, as amended (19 U.S.C. 1337), and in part 210 of the Commission's Rules of Practice and Procedure (19 CFR part 210).

By order of the Commission.

A handwritten signature in black ink, appearing to read 'Lisa R. Barton', written in a cursive style.

Lisa R. Barton
Secretary to the Commission

Issued: September 14, 2018

PUBLIC CERTIFICATE OF SERVICE

I, Lisa R. Barton, hereby certify that the attached **COMMISSION OPINION** has been served upon the following parties as indicated, on **September 14, 2018**.



Lisa R. Barton, Secretary
U.S. International Trade Commission
500 E Street, SW, Room 112
Washington, DC 20436

On Behalf of Complainant Cisco Systems, Inc.:

Adam R. Alper, Esq.
KIRKLAND & ELLIS LLP
555 California Street
San Francisco, CA 94104

- Via Hand Delivery
 Via Express Delivery
 Via First Class Mail
 Other: _____

On Behalf of Respondent Arista Networks, Inc.:

Bert C. Reiser, Esq.
LATHAM & WATKINS LLP
555 Eleventh Street, NW, Suite 1000
Washington, DC 20004

- Via Hand Delivery
 Via Express Delivery
 Via First Class Mail
 Other: _____

**UNITED STATES INTERNATIONAL TRADE COMMISSION
Washington, D.C.**

In the Matter of

**CERTAIN NETWORK DEVICES,
RELATED SOFTWARE AND
COMPONENTS THEREOF (II)**

**Investigation No. 337-TA-945
(Modification 2)**

**MODIFICATION OF LIMITED EXCLUSION ORDER
AND CEASE AND DESIST ORDER;
TERMINATION OF THE MODIFICATION PROCEEDING AS TO
U.S. PATENT NO. 6,377,577 AND SUSPENSION OF THE MODIFICATION
PROCEEDING AS TO U.S. PATENT NO. 7,224,668**

AGENCY: U.S. International Trade Commission.

ACTION: Notice.

SUMMARY: Notice is hereby given that the U.S. International Trade Commission has determined to modify a limited exclusion order and a cease and desist order (“the remedial orders”) issued against Arista Networks, Inc. of Santa Clara, California (“Arista”) in Inv. No. 337-TA-945. The above-captioned modification proceeding is terminated as to U.S. Patent No. 6,377,577 (“the ’577 patent”) and is suspended as to U.S. Patent No. 7,224,668 (“the ’668 patent”).

FOR FURTHER INFORMATION CONTACT: Megan M. Valentine, Office of the General Counsel, U.S. International Trade Commission, 500 E Street, S.W., Washington, D.C. 20436, telephone (202) 708-2301. Copies of non-confidential documents filed in connection with this investigation are or will be available for inspection during official business hours (8:45 a.m. to 5:15 p.m.) in the Office of the Secretary, U.S. International Trade Commission, 500 E Street, S.W., Washington, D.C. 20436, telephone (202) 205-2000. General information concerning the Commission may also be obtained by accessing its Internet server at <https://www.usitc.gov>. The public record for this investigation may be viewed on the Commission’s electronic docket (EDIS) at <https://edis.usitc.gov>. Hearing-impaired persons are advised that information on this matter can be obtained by contacting the Commission’s TDD terminal on (202) 205-1810.

SUPPLEMENTARY INFORMATION: The Commission instituted this investigation on January 27, 2015, based on a Complaint filed by Cisco Systems, Inc. of San Jose, California (“Cisco”). 80 FR 4313-14 (Jan. 27, 2015). The Complaint alleges violations of section 337 of the Tariff Act of 1930, as amended, 19 U.S.C. § 1337 (“section 337”), by reason of infringement of certain claims of U.S. Patent Nos. 7,023,853 (“the ’853 patent”); the ’577 patent; 7,460,492 (“the ’492 patent”); 7,061,875 (“the ’875 patent”); the ’668 patent; and 8,051,211 (“the ’211 patent”). The Complaint further alleges the existence of a domestic industry. The Commission’s

Notice of Investigation named Arista as the respondent. The Office of Unfair Import Investigations (“OUII”) was also named as a party to the investigation. The Commission terminated the investigation in part as to certain claims of the asserted patents. Notice (Nov. 18, 2015) (see Order No. 38 (Oct. 27, 2015)); Notice (Dec. 1, 2015) (see Order No. 47 (Nov. 9, 2015)).

On June 11, 2016, the Patent Trial and Appeal Board (“PTAB”) of the U.S. Patent and Trademark Office instituted separate *inter partes* review (“IPR”) proceedings concerning the ’577 and ’668 patents. *Arista Networks, Inc. v. Cisco Systems, Inc.*, Case IPR2016-00303 (regarding the ’577 patent); *Arista Networks, Inc. v. Cisco Systems, Inc.*, Case IPR2016-00309 (regarding the ’668 patent).

On May 4, 2017, the Commission found a violation of section 337 with respect to certain of the asserted claims of the ’577 and ’668 patents. Notice (May 4, 2017); 82 FR 21827-29 (May 10, 2017); *see also* Notice of Correction (May 30, 2017); 82 FR 25811 (June 5, 2017). The Commission issued a limited exclusion order (“LEO”) and a cease and desist order (“CDO”) against Arista. *Id.* The Commission did not find a violation with respect to the ’853, ’875, ’492, and ’211 patents. *Id.*

On May 25, 2017, the PTAB issued its final written decision finding claims 1, 7-10, 12-16, 18-22, 25, and 28-31 of the ’577 patent unpatentable based on prior art not presented in the Commission investigation. On June 1, 2017, the PTAB issued its final written decision finding claims 1-10, 12, 13, 15-28, 30, 33-36, 55-64, 66, 67, and 69-72 of the ’668 patent unpatentable based on certain combinations of prior art not presented in the Commission investigation.

On June 30, 2017, Cisco filed a notice of appeal with the United States Court of Appeals for the Federal Circuit (“Federal Circuit”), seeking review of the Commission’s finding of no violation as to the ’853, ’875, ’492, and ’211 patents. *Cisco Sys., Inc. v. Int’l Trade Comm’n*, Appeal No. 17-2289. On July 21, 2017, Arista filed a notice of appeal with the Federal Circuit, seeking review of the Commission’s finding of violation as to the ’577 and ’668 patents. *Arista Networks, Inc. v. Int’l Trade Comm’n*, Appeal No. 17-2336. On August 3, 2017, the Federal Circuit consolidated the Arista and Cisco appeals. *Cisco Sys., Inc. v. Int’l Trade Comm’n*, Appeal No. 17-2289, Dkt. No. 20. The consolidated appeal is currently pending before the Federal Circuit.

On August 25, 2017, Arista filed a motion with the Federal Circuit seeking to stay the Commission’s remedial orders pending resolution of the appeal on the merits. On September 22, 2017, the Federal Circuit denied this request “subject to the condition that the product redesign on which Cisco relies to deny irreparable harm must be permitted to enter the country, without being blocked by the Commission order under review in this case, unless and until Commission proceedings are initiated and completed to produce an enforceable determination that such a redesign is barred by the order here under review or by a new or amended order.” *Cisco Sys, Inc. v. ITC; Arista Networks, Inc. v. ITC*, Appeal Nos. 2017-2289, -2351, Order at 3 (Fed. Cir. Sept. 22, 2017).

On September 27, 2017, Cisco petitioned for a modification proceeding to determine whether Arista's redesigned switches infringe the patent claims that are the subject of the LEO and CDO issued in this investigation and for modification of the remedial orders to specify the status of these redesigned products.

On November 1, 2017, the Commission instituted the modification proceeding. 82 FR 50678 (Nov. 1, 2017). On November 7, 2018, the Commission issued a notice clarifying that OUII is not named as a party in the modification proceeding. 82 FR 52318 (Nov. 13, 2017).

On February 14, 2018, the Federal Circuit summarily affirmed the PTAB's decision finding the claims of the '668 patent unpatentable. *Cisco Systems, Inc. v. Arista Networks, Inc.*, Appeal No. 17-2384, Order (Feb. 14, 2018). The Court issued the mandate on March 23, 2018. *Id.*, Dkt. No. 54.

On March 15, 2018, Arista filed a motion before the Commission to stay the Commission's remedial orders as to the '668 patent. On March 26, 2018, Cisco filed its response stating that it takes no position on Arista's motion.

On March 23, 2018, the ALJ issued a recommended determination in the modification proceeding ("MRD"), finding that Arista's redesigned products infringe the relevant claims of the '668 patent but do not infringe the relevant claims of the '577 patent. MRD (Mar. 23, 2018). Also on March 23, 2018, the ALJ issued an order denying Arista's motion to stay the modification proceedings or to stay the remedial orders with respect to the '668 patent. Order No. 20 (Mar. 23, 2018).

On April 5, 2018, the Commission determined to modify the remedial orders to suspend enforcement of those orders with respect to the '668 patent. Notice (Apr. 5, 2018); Comm'n Order (Apr. 5, 2018).

Also on April 5, 2018, Cisco filed comments to the MRD, requesting review of the ALJ's findings that Arista's redesigned products do not infringe the relevant claims of the '577 patent. On the same day, Arista filed comments to the MRD, requesting review of the ALJ's finding that its redesigned products infringe the relevant claims of the '668 patent and preserving certain alternative grounds of affirmance regarding the ALJ's finding that the redesigned products do not infringe the relevant claims of the '577 patent.

Further on April 5, 2018, Arista filed a motion to stay the modification proceeding as to the '668 patent based on the Federal Circuit's affirmance of the PTAB's determination that the relevant claims of the '668 patent are unpatentable.

On April 12, 2018, Cisco and Arista filed responses to each other's comments.

On April 16, 2017, Cisco filed a response to Arista's stay motion.

Having examined the record of this modification proceeding, including the MRD, the comments to the MRD, and the responses thereto, the Commission has determined to find that Cisco has failed to show by a preponderance of the evidence that Arista's redesigned products infringe claims 1, 7, 9, 10, and 15 of the '577 patent or that Arista has indirectly infringed those

claim by contributing to or inducing infringement by its customers. Accordingly, the Commission has determined to modify the remedial orders to exempt Arista's redesigned products that were the subject of this modification proceeding. The modification proceeding is terminated with respect to the '577 patent.

The Commission has also determined to suspend the modification proceeding with respect to the '668 patent and to deny Arisa's motion to stay the modification proceeding as to the '668 patent as moot in light of the Commission's prior suspension of the remedial orders with respect to the '668 patent.

The authority for the Commission's determination is contained in section 337 of the Tariff Act of 1930, as amended (19 U.S.C. 1337), and in part 210 of the Commission's Rules of Practice and Procedure (19 CFR part 210).

By order of the Commission.

A handwritten signature in black ink, appearing to read "Lisa R. Barton". The signature is stylized and cursive.

Lisa R. Barton
Secretary to the Commission

Issued: June 26, 2018

PUBLIC CERTIFICATE OF SERVICE

I, Lisa R. Barton, hereby certify that the attached **NOTICE** has been served upon the following parties as indicated, on **June 27, 2018**.



Lisa R. Barton, Secretary
U.S. International Trade Commission
500 E Street, SW, Room 112
Washington, DC 20436

On Behalf of Complainant Cisco Systems, Inc.:

Adam R. Alper, Esq.
KIRKLAND & ELLIS LLP
555 California Street
San Francisco, CA 94104

- Via Hand Delivery
- Via Express Delivery
- Via First Class Mail
- Other: _____

On Behalf of Respondent Arista Networks, Inc.:

Bert C. Reiser, Esq.
LATHAM & WATKINS LLP
555 Eleventh Street, NW, Suite 1000
Washington, DC 20004

- Via Hand Delivery
- Via Express Delivery
- Via First Class Mail
- Other: _____

PUBLIC VERSION

**UNITED STATES INTERNATIONAL TRADE COMMISSION
Washington, D.C.**

In the Matter of

**CERTAIN NETWORK DEVICES,
RELATED SOFTWARE AND
COMPONENTS THEREOF (II)**

Investigation No. 337-TA-945

(Modification 2)

COMMISSION OPINION

I. BACKGROUND

The Commission instituted this investigation on January 27, 2015, based on a Complaint filed by Cisco Systems, Inc. of San Jose, California (“Cisco”). 80 *Fed. Reg.* 4313-14 (Jan. 27, 2015). The Complaint alleges violations of section 337 in the sale for importation, importation, and sale within the United States after importation of certain network devices, related software and components thereof, by reason of infringement of certain claims of U.S. Patent Nos. 7,023,853 (“the ’853 patent”), 7,061,875 (“the ’875 patent”), 7,460,492 (“the ’492 patent”), 8,051,211 (“the ’211 patent”), 6,377,577 (“the ’577 patent”), and 7,224,668 (“the ’668 patent”). The Complaint further alleges the existence of a domestic industry. The Commission’s Notice of Investigation names Arista Networks, Inc. of Santa Clara, California (“Arista”) as the respondent. The Office of Unfair Import Investigations (“OUII”) was also named as a party to the investigation. The Commission later terminated the investigation in part as to certain claims of the asserted patents. Notice (Nov. 18, 2015) (*see* Order No. 38 (Oct. 27, 2015)); Notice (Dec. 1, 2015) (*see* Order No. 47 (Nov. 9, 2015)).

PUBLIC VERSION

On June 11, 2016, the Patent Trial and Appeal Board (“PTAB”) of the U.S. Patent and Trademark Office (“PTO”) instituted separate *inter partes* review proceedings concerning the ’577 and ’668 patents. *Arista Networks, Inc. v. Cisco Systems, Inc.*, Case IPR2016-00303 (regarding the ’577 patent); *Arista Networks, Inc. v. Cisco Systems, Inc.*, Case IPR2016-00309 (regarding the ’668 patent).

On May 4, 2017, the Commission issued its final determination, finding a violation of section 337 with respect to claims 1, 7, 9-10, and 13 of the ’577 patent and claims 1, 2, 4, 5, 7, 8, 10, 13, 18, 56, and 64 of the ’668 patent. Notice (May 4, 2017); 82 *Fed. Reg.* 21827-29 (May 10, 2017); 82 *Fed. Reg.* 25811 (June 5, 2011) (notice of correction). As noted above, the Commission issued remedial orders against Arista. *Id.*

On May 25, 2017, the PTAB issued its final written decision finding claims 1, 7-10, 12-16, 18-22, 25, and 28-31 of the ’577 patent unpatentable based on prior art not presented in the Commission investigation. On June 1, 2017, the PTAB issued its final written decision finding claims 1-10, 12, 13, 15-28, 30, 33-36, 55-64, 66, 67, and 69-72 of the ’668 patent unpatentable based on certain combinations of prior art not presented in the Commission investigation.

On July 21, 2017, Arista filed a petition with the Federal Circuit, seeking review of the Commission’s finding of violation of section 337. *Arista Networks, Inc. v. Int’l Trade Comm’n*, Appeal No. 17-2351.¹ Arista also filed a motion with the Federal Circuit to stay enforcement of

¹ Cisco filed an appeal from the Commission’s determination of no violation of Section 337 in the underlying investigation on June 30, 2017, with respect to the ’853, ’875, ’492, and ’211 patents. *Cisco Sys., Inc. v. Int’l Trade Comm’n*, Appeal No. 17-2289. On August 3, 2017, the Federal Circuit consolidated the Arista and Cisco appeals. *Id.*, Dkt. No. 20.

PUBLIC VERSION

the remedial orders pending the appeal. The Court subsequently denied Arista's motion for a stay but ruled that Arista be allowed to import its redesigned products pending adjudication of those products by the Commission. Order (Dkt. No. 57) (Sept. 22, 2017).

On September 27, 2017, Cisco filed a petition requesting the Commission to institute a modification proceeding pursuant to Commission Rule 210.76(a)(1) (19 C.F.R. § 210.76(a)(1)) to determine whether Arista's redesigned products infringe the claims of the '668 and '577 patents upon which the Commission based its determination of violation of section 337. On November 1, 2017, the Commission instituted the current modification proceeding. 82 Fed. Reg. 50678 (Nov. 1, 2017). On November 7, 2018, the Commission issued a notice clarifying that OUII is not named as a party in the modification proceeding. 82 Fed. Reg. 52318 (Nov. 13, 2017).

On February 14, 2018, the Federal Circuit summarily affirmed the PTAB's decision finding unpatentable certain claims of the '668 patent. *Cisco Systems, Inc. v. Arista Networks, Inc.*, Appeal No. 17-2384, Order (Feb. 14, 2018). The Court issued the mandate on March 23, 2018. *Id.*, Dkt. No. 54.² The time for Cisco to file a petition for a writ of certiorari has expired. As of the date of this opinion, the PTO has not yet issued a certificate of cancellation regarding the relevant claims of the '668 patent.

On March 15, 2018, Arista filed a motion before the Commission to stay the Commission's remedial orders as to the '668 patent. On March 22, 2018, before Cisco filed its

² The Court's decision regarding the PTAB's final determination with respect to the '577 patent remains pending as of the date of this opinion.

PUBLIC VERSION

response to Arista's March 15, 2018 motion before the Commission, Arista filed a motion with the Federal Circuit asking for identical relief and arguing that the Court need not wait for the Commission to act because the Commission would likely deny Arista's motion.

On March 23, 2018, the ALJ issued a recommended determination in the modification proceeding ("MRD"),³ finding that Arista's redesigned products infringe the relevant claims of the '668 patent but do not infringe the relevant claims of the '577 patent. MRD (Mar. 23, 2018). Also on March 23, 2018, the ALJ issued an order denying Arista's motion to stay the modification proceedings or to stay the remedial orders with respect to the '668 patent. Order No. 20 (Mar. 23, 2018). In particular, the ALJ found that only the Commission has the authority to stay enforcement of its remedial orders. *Id.* at 7.

On April 5, 2018, the Commission determined to modify the remedial orders to suspend enforcement of those orders with respect to the '668 patent. Notice (Apr. 5, 2018); Comm'n Order (Apr. 5, 2018). On April 11, 2018, the Federal Circuit denied as moot Arista's stay motion before the court. *Cisco Sys., Inc. v. Int'l Trade Comm'n*, Appeal No. 17-2289, -2351, Dkt. No. 89 (Apr. 11, 2019).⁴

Also on April 5, 2018, Cisco filed comments to the MRD requesting review of the ALJ's findings that Arista's redesigned products do not infringe the relevant claims of the '577 patent.⁵

³ The ALJ incorrectly styled the MRD as an "Initial Determination." *See* 19 C.F.R. § 210.76(b).

⁴ Cisco did not petition the Federal Circuit for rehearing of its affirmance of the PTAB's determination regarding the '668 patent and did not pursue certiorari. Accordingly, all appeals concerning the '668 patent have been exhausted. *See* 35 U.S.C. § 318(b).

⁵ Complainant Cisco Systems, Inc.'s Comments on the Recommended Determination (Apr. 5,

PUBLIC VERSION

On the same day, Arista filed comments to the MRD requesting review of the ALJ's finding that its redesigned products infringe the relevant claims of the '668 patent and preserving certain alternative grounds of affirmance regarding the ALJ's finding that the redesigned products do not infringe the relevant claims of the '577 patent.⁶

Further on April 5, 2018, Arista filed a motion to stay the modification proceeding as to the '668 patent based on the Federal Circuit's affirmance of the PTAB's determination that the relevant claims of the '668 patent are unpatentable.⁷

On April 12, 2018, Cisco and Arista filed responses to each other's comments on the MRD.⁸

On April 16, 2018, Cisco filed a response to Arista's stay motion.⁹

2018) ("Cisco Cmm't.").

⁶ Respondent Arista Networks, Inc.'s Comments to the "Initial" Determination on Violation of Section 337 in Modification Proceeding 2, and Recommended Determination Regarding Modification of Remedy (Apr. 5, 2018) ("Arista Cmm't.").

⁷ Respondent Arista Network's Inc.'s Motion to Stay the Modification Proceeding as to the '668 Patent (Apr. 5, 2018).

⁸ Complainant Cisco Systems, Inc.'s Response to Arista's Comments on the Recommended Determination (Apr. 12, 2018) ("Cisco Resp."); Arista Networks, Inc. Response to Cisco's Comments to the "Initial" Determination on Violation of Section 337 in Modification Proceeding 2, and Recommended Determination Regarding Modification of Remedy (Apr. 12, 2018) ("Arista Resp.").

⁹ Complainant Cisco Systems, Inc.'s Response to Respondent Arista Network, Inc.'s Motion to Stay the Modification Proceeding as to the '668 Patent (Apr. 16, 2018).

PUBLIC VERSION

II. Relevant Law

1. Claim Construction

Claim construction “begin[s] with and remain[s] centered on the language of the claims themselves.” *Storage Tech. Corp. v. Cisco Sys., Inc.*, 329 F.3d 823, 830 (Fed. Cir. 2003); *Phillips v. AWH Corp.*, 415 F.3d 1303, 1312 (Fed. Cir. 2005) (*en banc*). The language used in a claim bears a “heavy presumption” that it has the ordinary and customary meaning that would be attributed to the words used by persons skilled in the relevant art. *Phillips*, 415 F.3d at 1312-13. To help inform the court of the ordinary meaning of the words, a court may consult the intrinsic evidence, including the claims themselves, the specification, and the prosecution history, as well as extrinsic evidence, such as dictionaries and treatises and inventor and expert testimony. *Id.* at 1314. In particular “the specification is always highly relevant to the claims construction analysis. Usually, it is dispositive; it is the single best guide to the meaning of a disputed term.” *Id.* at 1315 (internal quotations and citations omitted).

A court must “take care not to import limitations into the claims from the specification.” *Abbott Labs. v. Sandoz, Inc.*, 566 F.3d 1282, 1288 (Fed. Cir. 2009). “When the specification describes a single embodiment to enable the invention, this court will not limit broader claim language to that single application unless the patentee has demonstrated a clear intention to limit the claim scope using words or expressions of manifest exclusion or restriction.” *Id.* (internal quotations and citations omitted). “By the same token, the claims cannot enlarge what is patented beyond what the inventor has described as the invention. Thus this court may reach a narrower construction, limited to the embodiment(s) disclosed in the specification, when the claims themselves, the specification, or the prosecution history clearly indicate that the invention

PUBLIC VERSION

encompasses no more than that confined structure or method.” *Id.* (citations omitted).

“[T]he distinction between using the specification to interpret the meaning of a claim and importing limitations from the specification into the claim can be a difficult one to apply in practice . . . [h]owever, the line between construing terms and importing limitations can be discerned with reasonable certainty and predictability if the court’s focus remains on understanding how a person of ordinary skill in the art would understand the claim terms.” *Phillips*, 415 F.3d at 1323 (citations omitted). In attempting to discern whether a “patentee is setting out specific examples of the invention . . . or whether the patentee instead intends for the claims and the embodiments in the specification to be strictly coextensive . . . [t]he manner in which the patentee uses a term within the specification and claims usually will make the distinction apparent.” *Id.*

2. Infringement

The unfair acts covered under Section 337 include “all forms of infringement, including direct, contributory, and induced infringement.” *Suprema Inc. v. Int’l Trade Comm’n*, 796 F.3d 1338, 1352-53 (Fed. Cir. 2015) (en banc) (upholding the Commission’s authority to cover “goods that were used by an importer to directly infringe post-importation as a result of the seller’s inducement”). To establish infringement, there must be a preponderance of evidence. *See Kao Corp. v. Unilever United States, Inc.*, 441 F.3d 963 (Fed. Cir. 2006).

a. Direct Infringement

A determination of patent infringement encompasses a two-step analysis. *Advanced Cardiovascular Sys., Inc. v. Scimed Life Sys., Inc.*, 261 F.3d 1329, 1449 (Fed. Cir. 2001) (“*Scimed*”). First, the court determines the scope and meaning of the patent claims asserted, and

PUBLIC VERSION

then the properly construed claims are compared to the allegedly infringing device. *Id.* “Literal infringement of a claim exists when each of the claim limitations reads on, or in other words is found in, the accused device.” *Allen Eng. Corp. v. Bartell Indus.*, 299 F.3d 1449, 1345 (Fed. Cir. 2002).

Direct infringement includes the making, using, selling, offering for sale and importing into the United States an infringing product, without authority. 35 U.S.C. § 271(a). To prove direct infringement, the plaintiff must establish by a preponderance of the evidence that one or more claims of the patent read on the accused device either literally or under the doctrine of equivalents. *Scimed*, 261 F.3d at 1449.

b. Indirect Infringement

The Federal Circuit has held that “to prevail on contributory infringement in a Section 337 investigation, the complainant must show, *inter alia*, that: (1) there is an act of direct infringement in violation of Section 337; (2) the accused device has no substantial non-infringing uses; and (3) the accused infringer imported, sold for importation, or sold after importation within the United States, the accused components that contributed to another’s direct infringement.” *Spansion, Inc. v. International Trade Comm’n*, 629 F.3d 1331, 1353 (Fed. Cir. 2010). Section 271(c) also requires knowledge of the existence of the patent that is infringed. *Global-Tech Appliances, Inc. v. SEB S.A.*, 131 S. Ct. 2060, 2068 (2011).

“Whoever actively induces infringement of a patent shall be liable as an infringer.” 35 U.S.C. § 271(b). “A finding of inducement requires both knowledge of the existence of the patent and knowledge that the induced acts constitute patent infringement.” *Commil USA, LLC*

PUBLIC VERSION

v. Cisco Systems, Inc., 720 F.3d 1361, 1367 (Fed. Cir. 2013) (internal quotations omitted), *aff'd and vacated in part on other grounds*, 135 S. Ct. 1920, 1926-28 (2015). A patentee asserting a claim of inducement must show (i) that there has been direct infringement and (ii) that the alleged infringer “knowingly induced infringement and possessed specific intent to encourage another’s infringement.” *Minnesota Mining & Mfg. Co. v. Chemque, Inc.*, 303 F.3d 1294, 1304-05 (Fed. Cir. 2002). The intent to induce infringement may be proven with circumstantial or direct evidence and may be inferred from all the circumstances. *Commil*, 720 F.3d at 1366. With respect to the direct infringement requirement, the patentee “must either point to specific instances of direct infringement or show that the accused device necessarily infringes the patent in suit.” *ACCO Brands, Inc. v. ABA Locks Mfrs. Co., Ltd.*, 501 F.3d 1307, 1313 (Fed. Cir. 2007) (citation omitted). This requirement may be shown by circumstantial evidence. *Vita-Mix v. Basic Holding, Inc.*, 581 F.3d 1317, 1327 (Fed. Cir. 2009). “[A] finding of infringement can rest on as little as one instance of the claimed method being performed during the pertinent time period.” *Lucent Techs., Inc. v. Gateway, Inc.*, 580 F.3d 1301, 1317 (Fed. Cir. 2009).

III. ANALYSIS

A. '668 Patent

As noted in the procedural history, the Commission has suspended enforcement of the remedial orders with respect to the '668 patent in light of the Federal Circuit’s affirmance of the PTAB’s decision finding the claims of the '668 patent unpatentable. Notice (Apr. 5, 2018);

PUBLIC VERSION

Comm'n Order (Apr. 5, 2018).¹⁰ Accordingly, the modification proceeding with respect to the '668 patent is suspended. Arista's motion to stay the modification proceeding as to the '668 patent is denied as moot.

B. '577 Patent

1. Overview of the Technology – '577 Patent

U.S. Patent No. 6,377,577 is entitled "Access Control List Processing in Hardware." '577 Patent (JX-0005). The Commission found a violation of section 337 based on Arista's infringement of claims 1, 7, 9, 10, and 15 of the '577 patent ("the relevant claims").

The '577 patent provides generally for hardware processing of access control lists ("ACLs") and hardware enforcement of access control. '577 Patent (Abstract). Network devices, such as a router¹¹ or a switch, in a computer network may implement access control by restricting the transmission of information from specified source devices to specified destination devices. '577 Patent at 1:4-8. One technique for implementing access control involves reference to one or more ACLs, which describe whether the transmission of information is permitted or prohibited from a certain sender (or range of senders) to a certain destination (or range of destinations). *Id.* at 1:10-15. ACLs are associated with input interfaces and independently with output interfaces for each network device, *e.g.*, a router. *Id.* at 1:20-22. Each ACL includes a

¹⁰ The PTO has not yet issued a certificate of cancellation regarding the relevant claims of the '668 patent.

¹¹ Routers route messages (in the form of individual packets of information) from source devices to destination devices. *Id.* at 1:8-10.

PUBLIC VERSION

plurality of access control specifiers, each of which selects Internet Protocol (IP) address prefixes or subnet¹² addresses, or port numbers, for a range of sender and destination devices. *Id.* at 1:15-18. As packets of information arrive at a router for transmission, the router checks the packets¹³ against the access control specifiers that were provided in the ACL to determine whether transmission from the selected set of senders to the selected set of destinations is either specifically permitted or specifically denied. *Id.* at 1:18-20.

The '577 patent recognizes that the prior art implementations of processing packets to enforce access control according to an ACL are slow and processor-intensive, especially when access control is implemented using software processing instead of hardware processing. *Id.* at 2:3-26. In particular, if the ACL includes numerous entries of access control specifiers, more time is required to process the access control specifiers for each packet. *Id.* at 2:9-17. Moreover, for large ACLs, routing speed can be several orders of magnitude lower than the wirespeed rate of incoming packets. *Id.* at 2:18-24.¹⁴

¹² A subnetwork, or subnet, is a logical, visible subdivision of an IP network. The practice of dividing a network into two or more networks is called subnetting. Computers that belong to a subnet are addressed with a common, identical, most-significant bit-group in their IP address. *Comm'n Op.* at 22-23 n.13.

¹³ Messages exchanged in a computer network are in the form of packets of information. '577 Patent at 1:6-10. A packet includes a header containing the identifications of the source device and the destination device. *Id.* at Fig. 2, 2:41-43, 4:1-4.

¹⁴ The '577 patent provides a circa year 2002 example of router speed being reduced to as low as about 10,000 packets per second, while the wirespeed rate of incoming packets (for relatively short packets) is in the range of about tens to hundreds of millions of packets per second for gigabit networks. *Id.*

PUBLIC VERSION

To address the slowness problem, the '577 patent teaches hardware processing of ACLs, which is faster than software processing, and teaches processing the access control specifiers in parallel, which is faster than sequential processing. *Id.* at 2:27-30, 38-40, 3:41-44, 7:40-44.

First, access control specifiers from an ACL are recorded in a content-addressable memory (CAM) of a router. *Id.* at 2:29-32, 40-41. When a packet arrives at the router, it extracts certain information from the header, such as the source and destination IP addresses, port numbers, and any relevant protocols. *Id.* at 2:33-34, 41-43. The router then attempts to match the packet header information to all the access control specifiers stored in the CAM in parallel. *Id.* at 2:34-35, 43-44, 7:40-42. One or more successful matches are sent to a priority selector, which selects the match with the highest priority (the match that is first in the sequence of access control specifiers), and the selected match determines whether to permit or deny the transmission of the packet. *Id.* at 2:44-49. These steps are performed in hardware without the need for software processing, thus increasing the speed at which access control is enforced. *Id.* at 2:28-30, 38-40, 49-50.

The relevant claims of the '577 patent are directed to methods for making a routing decision for a packet by matching in parallel a packet label derived from the packet with access control patterns stored in memory. '577 Patent at 7:34-8:28. The relevant claims are listed below:

1. A method, including the steps of maintaining a set of access control patterns in at least one associative memory;
receiving a packet label responsive to a packet, said packet label being sufficient to perform access control processing for said packet;

PUBLIC VERSION

matching matchable information, said matchable information being responsive to said packet label, with said set of access control patterns in parallel, and generating a set of matches in response thereto, each said match having priority information associated therewith;

selecting at least one of said matches in response to said priority information, and generating an access result in response to said at least one selected match; and

making a routing decision in response to said access result.

2. A method as in claim 1, including the step of performing at least two of said steps of receiving, matching, selecting, and making a routing decision, in parallel using a pipeline technique.

7. A method as in claim 1, wherein said associate memory includes a ternary content-associative memory.

9. A method as in claim 1, wherein said priority information for each said access control pattern is responsive to a position of said access control pattern in a memory.

10. A method as in claim 1, wherein said priority information includes a position in said associative memory, and said step of selecting includes choosing a first one of said matches.

15. A method as in claim 1, wherein said routing decision includes permitting or denying access for said packet.

'577 patent at 7:34-8:28.

2. Arista's Accused Redesigns

Arista's redesigned products ("Redesigned Switches") consist of device models 7010, 7020 (including 7020R), 7048, 7050 (including 7050X), 7060X, 7150, 7160, 7250X, 7260X, 7280 (including 7280E and 7280R), 7300 (including 7300X), and 7500 (including 7500E and 7500R), running EOS¹⁵ versions 4.18.2-REV2-FX, 4.18.2-REV2-FX.1, 4.19.0F through

¹⁵ "EOS" stands for extensible operating system. Final ID at 191.

PUBLIC VERSION

4.19.2.2F, and 4.19.2.3F (and later) and 4.20.1F (and later). MRD at ii n.1 (citing Black Tr. at 291:10-292:18; ¹⁶ RX-9001C (Sweeney Witness Statement) at Q/A 32-33, 338-39, 365; RBr., App. C.)).

The primary hardware change was introducing an [] into []¹⁷ [] to prevent redesigned versions of EOS software (which []) from supporting infringing functionality. The Redesigned Switches are denoted as [] hardware.¹⁸ *Id.* at 7-8. The Redesigned Switches include only models that have []. *Id.* at 8 (Black Tr. at 291:10-292:18; RX-9001C (Sweeney Witness Statement) at Q/A 32-33, 338-39, 365). The [] switches run only EOS versions [] (“Redesigned EOS”) and versions []

¹⁶ All transcript citations are to the 2018 hearing in the modification proceeding unless otherwise indicated.

¹⁷ “EPROM” stands for erasable programmable read-only memory.

¹⁸ Dr. Richard Black, Arista’s expert witness, explained the various [] for Arista’s switches during the 2018 Hearing. Black Tr. at 291:12-292:18 (“So Your Honor got it exactly right this morning about the []. The [] was []. And then as response to the 944 []. And in that instance, Arista, whose products are a combination of both hardware and software, ran on legacy, older versions of EOS, and those products had [] ACLs ... At the [], which I believe was [], Arista released [], which could not use the existing versions of EOS. So also, in addition, Arista produced redesigned software to run on its redesigned hardware, and those are [] ... you can run the newer software [on pre-redesigned hardware]. If you run it on pre-redesigned hardware, you will get [] ACLs, but that combination [].”)

PUBLIC VERSION

(“Hardened Redesigned EOS”). *Id.* at 8-9.¹⁹

3. Direct Infringement

Cisco accuses two features of the Redesigned Switches as each providing an independent basis for finding infringement of claims 1, 7, 9, 10, and 15 of the ’577 patent: (1) “disabled” [] ACL” functionality; and (2) filtered port mirroring. *Id.* at 98. The MRD finds that neither feature practices the relevant claims of the ’577 patent and, thus, does not infringe. *Id.* For the reasons discussed below, the Commission agrees and adopts the MRD’s ultimate finding of non-infringement with respect to the ’577 patent.

a. “Disabled” [] ACL” Functionality

1) MRD

The MRD notes that Arista represented both to U.S. Customs and Border Protection (“CBP”) and to the Federal Circuit “that the infringing functionality was *removed* from its products.” *Id.* (emphasis in original) (citing CX-9163C at 2 (“Arista’s redesign, when implemented, would remove the accused TCAM ACL feature from all of its switch products.”)). The MRD finds, however, that “Arista has not removed from its Redesigned Switches a subset of [] ACL’ functionality found to infringe in the Underlying Investigation.” *Id.* (citing Black Tr. at 291:2-9).²⁰ Specifically, the MRD finds that “Arista’s Redesigned

¹⁹ Hardened Redesigned EOS was created after [] *Id.* at 9 n.14 (citing Black Tr. at 296:24-297:8; RX-9001C (Sweeney Witness Statement) at Q/A 347-50; Almeroth Tr. at 183:3-22).

²⁰ Arista’s expert witness, Dr. Black, explained that he used the term “[] ACL’ . . . to capture the types of features” that were accused in the Underlying Investigation. Black Tr. at

PUBLIC VERSION

Switches still include, for example, [

],²¹ hardware required to use it (such as TCAMs), and the same ‘ip access list’ CLI command used to configure [] ACLs.” *Id.* at 99 (citing Almeroth Tr. at 111:21-112:19, 117:23-118:3; CX-9201C at 40:19-41:9, 108:6-9).

The MRD further finds, based on tests conducted by both Cisco’s expert witness, Dr. Almeroth, and Arista’s expert witness, Dr. Black, that the Redesigned Switches “[] the [] ACL’ functionality.” *Id.* (citing Almeroth Tr. at 112:25-113:5, 177:10-179:16; Black Tr. at 290:14-291:9; RDX9000C-9). Specifically, the MRD finds that when the parties’ experts “attempted to [

]” *Id.* (citing *id.*; *see also* RX-9001C (Sweeney Witness Statement) at Q/A 15, 27, 246-47; CPX-9047C []; JX-9014C at 1).

The MRD notes that Dr. Almeroth was [] *Id.* (citing Black Tr. at 293:21-296:2; RDS9000C-13). Cisco asserted that “Dr. Almeroth did not [

]” but merely “did what, in theory . . . []: that EOS is ‘an “open” system allowing users complete access to configure, customize, and program EOS.’”

288:18-20.

²¹ The MRD notes that this [] is true for only the Redesigned Switches running Redesigned EOS, not Hardened Redesigned EOS. *Id.* at 99 n.50.

PUBLIC VERSION

Id. at 99-100 (citing (CX-9129 at 1 (“It’s okay to leave the door unlocked”); JX-9017 at 1 (“Arista’s EOS makes it possible to provide customization”); Almeroth Tr. at 113:10-114:23).

Arista argued that “Dr. Almeroth relied on [],’ which is not []” and that he relied on Arista’s [], to which he had access due to his participation in the Underlying Investigation, to [

] ACL’ functionality.” *Id.* at 100-101. Arista noted that the “[]” *Id.* at 100 (citing Black Tr. at 297:9-19).

The MRD finds that Dr. Almeroth’s [] was due to his “access to Arista’s highly confidential internal documents and source code” *Id.* at 111 (citing Almeroth Tr. at 183:3-22 (“[]”)). The MRD rejects “Cisco’s assertion that Dr. Almeroth’s [] was based on ‘publicly-accessible files and publicly-available user instructions from Arista’” because Cisco failed to produce “evidence of similar behavior by Arista’s customers ‘possess[ing] a high level of technological sophistication’” *Id.* (citing CBr. at 48; Almeroth Tr. at 114:17-23, 116:1-117:8; JX-9017 (Arista Parser 101) at 1).

The MRD also finds that Cisco failed to “prov[e] by a preponderance of the evidence that Arista’s customers have used [] ACL’ functionality within [the] Redesigned Switches.” *Id.* at 114. Specifically, the MRD notes that “Cisco’s primary example of Arista’s customers’ purported use of [] ACL’ functionality occurred in [

PUBLIC VERSION

].” *Id.* (citing CBr. at 39; RRBr. at 2, 34 (citing Black Tr. at 298:19-299:25; RX-9019C; RX-9020C; RX-9021C)). The MRD finds, however, that those switches are not at issue in this modification proceeding. *Id.*; *see also id.* at 110 n.54.

Cisco argued that Arista should be “precluded from arguing that there is no evidence of customer use of ‘disable’ [] ACLs’ functionality in [the] Redesigned Switches.” *Id.* at 109. Cisco further argued that it was entitled to an “adverse inference of customer use” because Arista violated a discovery order (Order No. 12) “by refusing to produce customer communications on the use of [] ACL’ functionality in [the] Redesigned Switches” before the hearing, with Arista “purportedly attempt[ing] to produce such communications” only after the hearing. *Id.* at 109-110; *see* Order No. 12 (Jan. 19, 2018).

The MRD finds that Arista violated Order No. 12 and, thus, “is now precluded from arguing that there is no evidence of direct infringement of the ’577 patent based on [] ACL’ functionality in the Redesigned Switches.” *Id.* at 113. Moreover, the MRD finds, “Arista’s behavior has given rise to an adverse inference that it communicates with its customers regarding ways to use [] ACL’ functionality in []” *Id.* (citing *Certain Video Graphics Display Controllers*, Inv. No. 337-TA-412, Order No. 47, *at 5-6 (U.S.I.T.C. Jan. 14, 1999) (failure to comply with discovery orders and an “extremely late production of a large volume of responsive documents” on the eve of trial resulted in “the entry of a rebuttable adverse factual inference.”)).

The MRD explains, however, that the adverse inference does not apply to Arista’s

PUBLIC VERSION

Redesigned Switches running the redesigned EOS because “Arista has presented evidence that its Redesigned Switches [] ACL’ functionality.” *Id.*

Specifically, the MRD finds, that “Arista presented undisputed evidence that Dr. Almeroth’s [] is [

]” *Id.* (citing Black Tr. at 333:2-17; RX-9001C (Sweeney Witness Statement) at Q/A 344-47)). The MRD also finds that “Arista has also presented undisputed evidence that Dr. Almeroth’s [] is not possible in Hardened Redesigned EOS versions []” *Id.* (citing RBr. at App. C). *Id.* at 114.

2) Discussion

a) Arista Failed to Remove the [] ACL” Function from the Redesigned EOS

The first question presented is whether the Redesigned Switches actually contain [] ACL” function found to infringe in the Underlying Investigation. The dispute concerns only the Redesigned EOS, which Arista [] MRD at Appx B. After that date, Arista has imported only [], which does not support any [] ACL” function. *Id.* at 99 n.50, 113. Cisco does not accuse this version of Arista’s redesigned products of violating the remedial orders due to any retention of [] ACL” function. *See Cisco Cmm’t.* at 7-8, 15.

The MRD notes that Arista represented to both CBP and the Federal Circuit that it intended to “remove the accused TCAM ACL feature from all of its switch products.” MRD at

PUBLIC VERSION

98 (citing CX-9163²² at 2 (“Arista’s redesign, when implemented, would remove the accused [CAM] ACL feature from all of its switch products.”)); *see also* CX-9164C²³ at 3 ¶ 11 (“Arista is now in the process of completing and releasing its second redesign, which removes all of the accused, industry-standard features and replaces some of them with alternative features designed specifically to avoid the functions the Commission found to infringe.”).

Concerning the technical question of whether the Redesigned Switches contain the [] ACL” function, the MRD finds that Arista has not removed the functionality. MRD at 98 (citing Black Tr. at 291:2-9). Arista asserts that “[w]hile the [] ACLs [] imported and sold before the LEO and CDO, it does not [] ACLs []” Arista Cmm’t. at 80-81 (emphasis in original) (citing Almeroth Tr. at 112:25–113:5, 177:10–179:16; Black Tr. at 290:14–292:18; RDX-9000C-9-10). Specifically, Arista admits that “the [] ACLs.” Arista Resp. at 22.

The dispute is whether “removal” of the [] ACL” function requires that the [] from the Redesigned EOS or whether merely disabling or

²² Declaration of Anshul Sadana in Support of Respondent Arista Networks Inc.’s Emergency Petition to Modify, Suspend, or Rescind Remedial Orders Pending Appeal of the Patent Trial and Appeal Board’s Invalidation of Complainant Cisco Systems, Inc.’s U.S. Patent No. 6,377,577 and Request for Shortened Response Time and Expedited Consideration.

²³ Declaration of Anshul Sadana in Support of Emergency Motion to Stay Enforcement of Limited Exclusion Order and Cease and Desist Order.

PUBLIC VERSION

restricting user access to the functionality in the Redesigned EOS is sufficient. The MRD interprets the term to require the former, finding insufficient the testimony of Arista's expert, Dr. Black, that "[u]sers can't access" the function in the Redesigned EOS. MRD at 98 (citing Black Tr. at 291:2-9).

We agree with the MRD that the [] ACL" function was not technically "removed" from the Redesigned EOS (as opposed to the Hardened Redesigned EOS). As the MRD notes, Cisco's expert, Dr. Almeroth, was [

] ²⁴ [

]. MRD at 99 (citing Black Tr. at 293–296:2; RDX9000C-13).

Whether, however, Cisco's expert's [

] is sufficient to show infringement is a separate question, which we address *infra*.

b) Cisco is Required to Show Direct Infringement

Even accepting that the [] ACL" functionality found to infringe in the Underlying Investigation [], Cisco must still satisfy its burden in showing that Arista's customers have used the infringing functionality. *See Scimed*, 261 F.3d at 1449 (party alleging infringement bears the burden of proof); 19 C.F.R. § 210.37(a).

Cisco contends that it need show only that Arista has not removed the [

] ACL" function found to infringe in the Underlying Investigation. Cisco Cmm't. at 9.

²⁴ This version refers to the non-"Hardened" version. *See* MRD at 8-9.

PUBLIC VERSION

Cisco argues that “[i]mposing the burden to prove actual use of the infringing features conflicts with the statutory provision and rule governing modification proceedings.” *Id.* at 10 (citing 19 U.S.C. § 1337(k); 19 C.F.R. § 210.76)). Cisco contends that “the changed conditions of fact” warranting institution of the modification proceeding “were Arista’s redesign, which Arista represented had removed the infringing features.” *Id.* Cisco argues that the MRD’s finding that the Redesigned Switches “continue to have the very functionality that was purportedly removed . . . is a sufficient reason to modify the scope of the exclusion order to make clear this redesign is excluded.” *Id.* at 11. Cisco further asserts that “Arista’s provision of the products with [the infringing] functionality is plainly in violation of the Commission’s cease-and-desist order.” *Id.*

Arista argues that “Cisco conflates the standard for instituting a modification proceeding and determining whether it is appropriate to modify existing remedial orders.” Arista Resp. at 15. We agree. Cisco points to no law that would authorize the Commission to determine whether previously unadjudicated products fall within the scope of remedial orders without first determining whether those products infringe the relevant claims of the patent-at-issue. In fact, the Commission has explicitly found that the issue is “whether the language of the claims reads on the redesigned products as required under the standard two-part infringement analysis.”

Certain Network Devices, Related Software and Components Thereof (I), Inv. No. 337-TA-945 (Enforcement), Comm’n Order at (3) (Aug. 4, 2017); see *MBO Labs, Inc v. Becton, Dickinson & Co.*, 474 F.3d 1323, 1329 (Fed. Cir. 2007).

The relevant claims of the ’577 patent are all method claims. See ’577 patent at claims 1, 7, 9, 10, and 15. A process or method claim is infringed only if each step of the claimed method

PUBLIC VERSION

is performed. *Muniauction, Inc. v. Thomson Corp.*, 532 F.3d 1318, 1328 (Fed. Cir. 2008). The mere sale or importation of an apparatus capable of performing the patented method does not constitute infringement. *Joy Techs., Inc. v. Flakt, Inc.*, 6 F.3d 770, 775 (Fed. Cir. 1993). Cisco alleges that Arista is contributing to the infringement of or inducing its customers to infringe the relevant claims of the '577 patent by practicing the method claims at issue.

c) Imposition of Adverse Inference Sanction

The MRD notes that “[t]here was a discovery dispute over the production of documents in Arista’s possession, custody or control containing communications that Arista provided to customers after it redesigned its switches.” MRD at 111 n.55 (citing Dec. 8, 2017 Telephonic Hearing Tr. at 18-20, Doc. ID No. 631471 (Dec. 8, 2017)). The MRD finds that Arista is “precluded from arguing that there is no evidence of direct infringement of the '577 patent based on [] ACL’ functionality in the Redesigned Switches.” *Id.* at 113. The MRD further finds that “Arista’s behavior” during discovery “has given rise to an adverse inference that it communicates with its customers regarding ways to use [] ACL’ functionality in switches running any version of EOS other than the redesigned versions.” *Id.* The MRD declined, however, to draw an adverse inference concerning Arista’s Redesigned Switches “because Arista has presented evidence that its Redesigned Switches [] ACL’ functionality.” *Id.* The circumstances of the discovery dispute are set forth below.

On December 8, 2017, the ALJ held a teleconference as part of Cisco’s motion to compel from Arista, *inter alia*, documents related to Arista’s communication with its customers

PUBLIC VERSION

concerning the redesigned switches. Order No. 12 at 2-3. Leading up to the teleconference, Cisco submitted a letter to the ALJ explaining that, “[a]fter multiple meet and confers” with Arista, “Arista ***had not produced a single communication*** with its customers or suppliers as of December 7[, 2017].” *Id.* at Attachment 1 (Ltr. from Mr. Alper to Judge McNamara (Dec. 8, 2018) at 4) (emphasis in original)). According to Cisco, Arista never denied the existence of such documents but, instead, delayed until two days before the teleconference to begin its search for responsive documents, though Cisco had served its discovery request a month prior. *Id.* Cisco noted Arista’s argument that “its delay stem[med] from its request that Cisco provide Arista with a set of search terms[,]” but contended that “Arista’s obligation to respond to relevant discovery requests is not contingent on Cisco providing search terms.” *Id.* at 5. Even after providing search terms, Cisco argued, Arista still “complained that the terms were too broad, without providing a counter proposal.” *Id.*; *see id.* at 29 (Arista arguing that multiple rounds of negotiation were necessary regarding the search terms). Cisco asserted that this cycle continued at least once more, with Arista agreeing to begin its search with further revised terms Cisco provided “with just a week left in discovery” *Id.* Cisco noted that Arista finally “produced nearly 150,000 pages²⁵ of documents” early in the morning of the teleconference,²⁶ denying Cisco the opportunity to conduct a meaningful review before the deposition of Arista’s corporate witness, Mr. Sweeney, was due to begin. *Id.* During the teleconference, Cisco contended that “the ALJ held that Cisco was ‘entitled’ to documents responsive to [Cisco’s request for customer

²⁵ Arista notes that it produced 144,978 pages of documents. *Id.* at 29.

²⁶ Arista asserted that it produced these documents on December 7, 2017. *Id.*

PUBLIC VERSION

communications] and accepted Arista's representation that it would provide Cisco with Arista's search terms" Cisco Mot. *in limine* No. 1 (Jan. 5, 2018) at 2 (citing EDIS Doc No. 629902 (Dec. 8, 2017 Teleconference Tr.) at 8:19-24, 11:11-23 (Dec. 12, 2017)); *see also* Arista Resp. at 30-31 ("the ALJ stated 'I think Cisco is also entitled to this.'").

According to Arista, Cisco's "sole complaint" during the teleconference regarding why it had not yet reviewed the approximately 150,000 pages Arista had recently provided was because it "did not 'have any information about what terms [Arista had] actually run' to identify the pages already produced." Arista Resp. at 30 (citing (Dec. 8, 2017 Tr. at 10:3-13, 10:25-11:3)).²⁷ Arista notes that, "[i]n response, the ALJ ordered Arista to provide Cisco with its list of search terms." *Id.* (citing Dec. 8, 2017 Tr. at 11:11-23). Arista contends that this was the only order it received from the ALJ concerning the alleged customer communications regarding the Redesigned Switches. *Id.* Arista asserts that "the ALJ acknowledged that Arista had already produced the responsive documents to Cisco." *Id.* (citing Dec. 8, 2017 Tr. at 12:7-8 ("You will get the search terms today. *You have your documents.*"), 13:9-14 ("RFP 16, the communications between Arista and the third parties on the redesign. And that was my understanding—*it was my understanding that it was 150,000 documents that were produced related to that . . .*") (emphasis in Arista's Resp.)).

Cisco asserted that, after a further set of meet and confers, "Arista ultimately proposed supplementing its production based on 16,535 documents that hit an expanded set of terms."

²⁷ Cisco actually stated that the lack of search terms was "part" of its difficulty. *Id.* at 10:3.

PUBLIC VERSION

Cisco Mot. *in limine* No. 1 at 3; *see also* Arista Resp. at 30 (“During the meet and confer process, Arista tested modifications to Cisco’s search terms which hit on approximately 16,000 additional documents.”). Cisco argued that Arista ultimately refused to produce these documents, “demanding that Cisco must agree to produce documents on prior art, domestic industry, and customer communications.” *Id.* Arista asserts that Cisco subsequently “continued to demand that Arista only use Cisco’s search terms which would have required a production of an additional 194,000 emails.” Arista Resp. at 30. Arista contends that the parties reached an impasse, and that “Cisco chose not to file a motion to compel during the discovery period.” *Id.* at 31.

Cisco subsequently moved *in limine* to preclude Arista from offering evidence or argument on various issues on which Arista purportedly withheld relevant discovery, including relevant communications between Arista and its customers on their use of the Redesigned Switches. In particular, Cisco alleged that “although Arista subsequently [identified to] Cisco [] more than 16,000 customer communications using its own search terms, Arista has not produced the documents.” Order No. 12 at 3. The ALJ granted Cisco’s motion, finding that, “to the extent Arista seeks to argue that its allegedly redesigned products do not infringe, and is expecting to do so by relying upon any documentation or other evidence . . . not produced to Cisco . . . Arista is precluded from using it during the evidentiary hearing.” *Id.* at 11.

Arista acknowledges that the ALJ directed it “to produce some customer communications and to provide search terms to Cisco.” Arista Cmm’t. at 79 n. 17 (citing Dec. 8, 2017 Tr. at 11:17-23). Arista argues, however, that it did, in fact produce the documents and that “Cisco

PUBLIC VERSION

never moved to compel any further discovery.” *Id.* Arista contends, therefore, that it was not obligated to produce any additional documents. The ALJ explains, however, that she did, in fact, order Arista to produce documents “regarding communications between Arista and third-parties, such as customers and suppliers.” Order No. 12 at 3 n. 2 (citing Dec. 8, 2017 Tr. at 8:19-22). The ALJ elaborated that “while I was concerned that search terms were not unduly expansive and . . . overly burdensome for Arista, that did not change the fact that Arista was ordered to produce all available responsive documents that were relevant, not simply the search terms as Arista argues.” *Id.* Thus, the ALJ concluded, “[t]he import of at least part of the discussion was that while Arista had produced some 140,000 documents, there might be others that Arista was required to produce.” *Id.* The ALJ reiterated her decision at the evidentiary hearing. Tr. at 26:11-27:2 (“What is absolutely clear is that Cisco was entitled to customer information . . . what I was trying to do was narrow the scope of the search terms so that Arista was not overburdened”). Only after the evidentiary hearing did Arista produce the additional 16,000 documents. *See* Arista Cmm’t. at 79; Cisco Resp. at 55.

Arista asserts in its comments to the Commission that it “never violated any discovery order, that Cisco never moved to compel any further production, that Arista produced all responsive customer communications concerning the redesign that it found during discovery, and that the adverse inference and preclusion recommended by the ALJ is legal error.” Arista Resp. at 33. Arista further argues that, as Cisco has acknowledged, “none of the [16,000] documents was a customer communication concerning the redesign or any means of [] ACLs on the redesigned switches.” *Id.* at 33-34 (citing Exh. 3 (Decl. of Richard Pell) at

PUBLIC VERSION

¶¶ 4-5); *see also* Arista Cmm't. at Ex. G (2/8/2018 J. Homrig Ltr. to A. Alper).

The question of whether Arista violated the ALJ's oral discovery order and the substantive content of the evidence of record are two different issues. Based on a review of this procedural background, we can find no error in the MRD's finding that Arista violated her discovery order. Arista decided without justification not to produce the set of approximately 16,000 documents at issue. Arista was directed to produce all documents responsive to RFP 16 during the December 8, 2017 teleconference. To the extent Arista may have been unsure whether it was required to produce the additional 16,000 documents that it located, it should have reached out to the ALJ and sought guidance as to whether it was obligated to produce those documents. Moreover, once the ALJ issued Order No. 12, Arista was under no illusion as to how the ALJ understood her instructions from the December 8, 2017 teleconference. But, rather than immediately produce the documents before the evidentiary hearing, Arista still declined to do so.

The Commission therefore finds as a sanction that the ALJ was correct in ruling that Arista is precluded from relying on any of documents not produced before the evidentiary hearing in arguing that there is no evidence of direct infringement of the '577 patent based on [] ACL' functionality in the Redesigned Switches. MRD at 113; Order No. 12 at 11. Moreover, the Commission adopts the MRD's finding that "Arista's behavior has given rise to an adverse inference that it communicates with its customers regarding [] ACL' functionality." *Id.*; 19 C.F.R. § 210.33(b).

We do, however, agree with Cisco that limiting the application of the adverse inference to

PUBLIC VERSION

[] does not appear to align with the discovery misconduct found by the ALJ. MRD at 113. Rather, as Cisco asserts, its document request pertained to the operation of Arista's redesigned switches. Cisco Cmm't. at 13-14. Based on the procedural background of this dispute and the context of the ALJ's discussion of this issue in the MRD, we conclude that the adverse inference applies to the redesigned versions. In our view, however, the evidence in the record does show, as the MRD finds, that Arista has successfully rebutted the inference drawn against it, as we discuss below.

d) Cisco Failed to Show that Arista's Redesigned Switches Infringe Based on Customer Use of [] ACL" Functionality

A tribunal, such as the Commission, "may properly draw an adverse inference when a party engages in discovery abuses even when no particular piece of evidence is missing, destroyed, or untimely produced." *See Regeneron Pharm., Inc. v. Merus N.V.*, 864 F.3d 1343, 1363 (Fed. Cir. 2017) (citing *Residential Funding Corp. v. DeGeorge Fin. Corp.*, 306 F.3d 99, 107 (2d Cir. 2002)). As Cisco notes, "an adverse inference should serve the function, insofar as possible, of restoring the prejudiced party to the same position he would have been in" had the misconduct not occurred. Cisco Cmm't. at 14 (citing *Kronish v. United States*, 150 F.3d 112, 126 (2d Cir. 1998), *overruled on other grounds*, *Rotella v. Wood*, 528 U.S. 549 (2000)).

A finding of adverse inference against Arista therefore means restoring Cisco to its "previous evidentiary position" absent Arista's withholding of the 16,000 documents that Arista produced only after the evidentiary hearing. Accordingly, and in keeping with the ALJ's Order No. 12, Arista may not rely on those documents. In addition, Arista may not argue that those

PUBLIC VERSION

documents do not contain relevant customer communications.

Despite the imposition of the adverse inference sanction, Cisco still retains the burden of proof on infringement. As the Federal Circuit has explained, any adverse inference “completely vanishes upon the introduction of evidence sufficient to support a finding of the nonexistence of the presumed fact.” *A.C. Aukerman Co. v. R.L. Chaides Constr. Co.*, 960 F.2d 1020, 1037 (Fed. Cir.1992), *abrogated on other grounds*, *SCA Hygiene Products Aktiebolag v. First Quality Baby Prods., LLC*, 137 S. Ct. 954 (2017). Therefore, even assuming that the documents Arista belatedly produced contain relevant customer communications regarding Arista’s Redesigned Switches, Cisco must still show that Arista’s customers have actually used the [

] ACL” functionality in [the] Redesigned Switches. As the MRD finds, Cisco has failed to do so. MRD at 113. More specifically, Arista has shown that it has taken reasonable steps to ensure that its customers cannot utilize the [] ACL” functionality in [the] Redesigned Switches. Furthermore, the evidence shows that Arista has taken steps to discourage [] with the Redesigned Switches, such as [] by Cisco’s expert Dr. Almeroth.

Cisco asserts that “an Arista customer could [] ACLs . . . [and] would be able to determine how to do so without any help from Arista.” Cisco Cmm’t. at 17. Specifically, Cisco contends that “Dr. Almeroth followed the Arista configuration instructions to [

], and, thus,

PUBLIC VERSION

[] ACL” functionality. *Id.* at 17-18.

Dr. Almeroth testified that he relied primarily on a publicly available Arista document entitled “Customizing EOS CLI – Parser 101” (JX-9017) in []” Almeroth Tr. at 114:17-23; CDX-9003C-21. Cisco asserts that Dr. Almeroth “relied exclusively on instructions that Arista provides to its customers on how to access configuration files for EOS software, such as the []²⁸ []” Cisco Cmm’t. at 18 (citing CDX-9003C-20-22; JX-9017 at 1). When asked to explain how he

[] Dr. Almeroth testified as follows:

So [CDX-9003C at] slide 22, there’s [] that’s referenced in JX-9017. In fact, could you go back 9 to slide 21. It says here in the middle, user live [P]ython 2.6, site packages and then there’s a CLI plug-in directory.

If you go to slide 22 this [] specifically referenced in this document. There’s [] that are shown on demonstrative 22. The [], and I [] and then []

[]]. And that testing is described in CX-9141C at 17 through 29.

Almeroth Tr. at 115:5-21; *see also* CDX-9003C-21:

²⁸ Dr. Almeroth explained that Python is a programming language, *i.e.*, a source code file containing configuration information. Almeroth Tr. at 115-1:4.

PUBLIC VERSION

[

]

CDX-9003C-22:

[

]

Dr. Almeroth admitted, however, that he was [

], which [

], due to his involvement in this

PUBLIC VERSION

case. Almeroth Tr. at 183:3-7; Arista Resp. at 10; *see also* MRD at 111 (finding that “Dr. Almeroth was in a unique position []”).

Arista contends that the “[]” Dr. Almeroth used is known as “[],” which involves “[].” Arista Resp. at 8 (citing Black Tr. at 293:15–295:23). Arista argues that Dr. Almeroth would not have been able to [] without access to Arista’s confidential information because “[].” Arista Resp. at 10 (citing Black 296:3–297; RX-9001C at Q/A 347; CX-9201C (Holbrook Dep. at 85:9–86:1, 284:13–285:24). Specifically, Arista contends that “Dr. Almeroth relied on the secret knowledge he gained from Arista in discovery concerning []

[] ACL functionality.” *Id.* (citing Almeroth Tr. at 18:3-7; Black 296:3–297:8; CPX-9047C []).

Arista’s corporate witness, Mr. Sweeney,²⁹ explained that:

In the first place, we []. The purpose of [], and we do not [], and even the []. Our customers cannot [].

²⁹ Adam Sweeney is a Vice President of Software Engineering for Arista. RX-9001C at Q/A 1.

PUBLIC VERSION

RX-9001C at Q/A 347. Arista's expert, Dr. Black, further explained that:

In order to [

]. And I don't think you could plausibly just guess at it. You have to understand how the whole thing works.

Black Tr. at 296:12-23. Dr. Almeroth also admitted at the evidentiary hearing that the CLI "Parser 101" document on which he relied (JX-9017) does not [

].” Almeroth Tr. at 181:24–182:2 (“Q. There’s no reference in this list of files to []? A. No. It doesn’t [list] that [] specifically.”). Moreover, Arista asserts that it “specifically prohibits [] by its End User License Agreement [EULA].” *Id.* (citing Black Tr. at 300:1-12; RX-9269C (EULA)).

Based on the evidence, the Commission adopts the MRD’s finding that Cisco has failed to show that Arista’s customers would be able to [] using publicly available information. MRD at 111. Moreover, the evidence shows that Arista has taken precautions to [] ACL” functionality in the Redesigned Switches running Redesigned EOS.³⁰

Cisco also asserts that [

³⁰ Again, Cisco does not assert that Redesigned Switches running Hardened Redesigned EOS are susceptible to []. *See id.* at 114.

PUBLIC VERSION

] MRD at 114; *see also* Cisco Cmm't. at 17, 18.

The MRD finds, however, that [

] *Id.* (citing CBr. at 39; RRB. at 2, 34 (citing Black Tr. at 298:19-299:25; RX-9019C; RX-9020C; RX-9021C); *see also id.* at 110 n.54. In its comment to the Commission, Cisco continues to assert that [

] Cisco Cmm't. at 17, 18. Cisco does not, however, dispute the MRD's finding that [

] ³¹ *See id.* at 17 (noting that []); *see also* MRD at ii n.1 (specifying the accused switch models). The MRD explains that the Redesigned Switches at issue "include only [

]." MRD at 8. As the MRD correctly finds, Arista's legacy switches are not at issue in this modification proceeding.³²

Based on the preceding discussion, the Commission finds that Cisco has failed to show by a preponderance of the evidence that Arista's customers have used []

³¹ Arista acknowledges that its "[] hardware, which will [] ACLs" Arista Resp. at 23 (citing Black Tr. at 291:10-292:18; RDX9000C-10).

³² Arista admits that it "[]". Arista Resp. at 13. The Redesigned Switches support only the [] Arista Post-Hearing Br. at 33, Appx. C; *see also* RX-9001C (1/5/18 Sweeney Witness Statement) at Q/A 32-33, 338 ("[]"); Black Tr. at 291:10-292:18; RDX-9000C-10.

PUBLIC VERSION

ACL” functionality in the Redesigned Switches.

b. Filtered Port Mirroring Functionality

1) MRD

Separate and apart from the [] ACL” functionality, Cisco also accuses the filtered port mirroring functionality in the Redesigned Switches of infringing the relevant claims of the ’577 patent. The MRD notes that filtered port mirroring functionality was available in Arista’s legacy switches. MRD at 114 n. 57. The MRD further notes that, although filtered port mirroring was present in Arista’s legacy switches accused in the Underlying Investigation, “Cisco did not specifically accuse filtered port mirroring of infringement in the Underlying Investigation, as required by Ground Rule 11.2.” *Id.* at 133³³; *see also id.* at 101 n.51. The ALJ, however, denied Arista’s “motion *in limine* to preclude Cisco from proffering evidence of infringement by filtered port mirroring because that functionality was not specifically accused in the Underlying Investigation[,]” finding that Cisco “raised a legitimate fact issue over whether filtered port mirroring in [the] Redesigned Switches was identical in operation to filtered port mirror in legacy switches” *Id.* 114 n.57 (citing Opp’n at 5-10 (EDIS Doc No. 633702) (Jan. 12, 2018); Order No. 11 at 10 (EDIS Doc No. 634262) (Jan. 19, 2018)).

³³ Ground Rule 11.2, which governs pre-hearing briefs, states that “[a]ny contentions not set forth with the level of particularity required herein shall be deemed abandoned or withdrawn, except for contentions of which a party is not aware and could not have been aware in the exercise of reasonable diligence at the time of filing the pre-hearing brief.” Inv. No. 945, Order No. 2 (Ground Rule 11.2) (Feb. 2, 2015).

PUBLIC VERSION

The MRD describes filtered port mirroring as follows:

Filtered port mirroring is a feature in Arista's Redesigned Switches that creates a copy of selected packets passing through a port and sends the copy to one or more "mirror ports." (Tr. (Black) at 303:16- 304:3, 304:9-305:12; RX-9001C (Sweeney Witness Statement) at Q/A 294, 302-03.). The "filtered" in filtered port mirroring refers to the selection of packets for mirroring using an ACL. (*Id.*). If a packet is selected for mirroring, a Redesigned Switch []. If a packet is not so selected, [] because, conceptually, []. (Tr. (Black) at 303:16-304:3, 304:9-305:12; RX-9001C (Sweeney Witness Statement) at Q/A 306-12.). Filtered port mirroring does not []; instead it merely []. (*Id.*). Notwithstanding a mirroring determination, the original packet []

[]. (*Id.*). Filtered port mirroring does not, and cannot, []; it's only concern is mirroring. (Tr. (Almeroth) at 192:8-23 (2018 Hearing); Tr. (Black) at 303:16-304:3, 304:9-305:12; RX-9001C (Sweeney Witness Statement) at Q/A 306-12; CX-9201C (Holbrook Dep. Tr.) at 282:5-284:12.).

Filtered port mirroring operates by initiating a port mirroring session. (JX-9020 at 742.). "A mirror session correlates a set of source ports to a [mirrored] destination port." (*Id.* at 740.). []

[]. (Tr. (Almeroth) at 108:18-110:5, 118:22-120:11, 124:1-24, 190:11-24; Tr. (Black) at 328:16-329:6, 329:18-330:10.). The source device, destination device, or both, can be specified in the port mirroring ACL. (Tr. (Almeroth) at 108:13-25, 109:13-25, 120:15-121:8, 169:25-170:2 (2018 Hearing); CDX-9003C-10; Tr. (Black) at 332:2-10.).

Id. at 102-103.

Cisco argued that "[

]." *Id.* at 103. Specifically, Cisco asserted

that: (1) "[p]ort mirroring ACLs are created through the same 'access list' command that was found in the 945 Investigation to generate the infringing TCAM ACLs"; (2) "[p]ort mirroring

PUBLIC VERSION

ACLs also utilize the [] as the []”;
and (3) “port mirroring ACLs use the same infringing [].” *Id.*

Arista argued that the ACLs used in the accused filtered port mirroring functionality are not used for “access control” because, rather than being used as “source-destination permit-deny ACLs,” they are instead used as a “packet classification ACL” *Id.* at 104 (citing JX-9023C (Maltz Decl.” at 2, 10 (“[]”));

Black Tr. at 310:10-311:2). Arista’s expert, Dr. Black, explained that “the []” are different when a “[]” is applied versus when []”. *Id.* (citing Black Tr. at 306:18-308:10; RDX9000C-31-33). Specifically, Dr. Black explained that “[w]hen a ‘source-destination permit-deny ACL’ was applied, the []—that is, the [].” *Id.* at 104-105

(citing Black Tr. at 322:25-323:2 (“Q. []”; correct? A. That’s correct.”; RDX-9000C-31 (depicting RX-9032C (Black/Sweeny Test Output))). By contrast, Dr. Black explained, “when filtered port mirroring was applied, the ‘[]’.” *Id.* at 105-106 (citing Black Tr. at 329:18-330:4 (“Q. ... []”). ... A. Well, []

PUBLIC VERSION

].”), 325:17-21, 328:24-330:10; JX-9020 (Arista User Guide Arista EOS version 4.20.1F 16 November 2017) at 742; Almeroth Tr. at 124:1-125:20; RDX-9000C-32 (depicting RX-9029C (Black/Sweeny Test Output))).

The MRD notes that, in the Underlying Investigation, “the Parties agreed that ‘access control should possess its plain and ordinary meaning.” *Id.* at 115 (citing *Markman* Order at 12; Final ID at 129). The MRD explains that the ‘557 patent defines “access control” as follows:

In a computer network for transmitting information, *messages can be restricted from being transmitted from selected source devices to selected destination devices*. In known computer networks, this form of restriction is known as ‘access control’ and is performed by routers, which route messages (in the form of individual packets of information) from source devices to destination devices.

Id. at 115-116 (emphasis in original) (citing ‘577 patent at 1:4-10; Almeroth Tr. at 168:8-20; Almeroth Tr. 2965:5-9 (945 Violation) (explaining that “access control” requires some semblance of packet policing or control over packet movement)). The MRD notes that “[t]ellingly, in the Underlying Investigation, [] packet transmission were the only functions Dr. Almeroth and Staff identified as satisfying the ‘access control’ limitation in Arista’s accused products.” *Id.* at 116 (citing Final ID at 132). As such, the MRD finds, “access control” involves control of packet movement from a source to a destination such that “[a]long the way, its transmission can be restricted.” *Id.* at 118-119.³⁴ The MRD also finds that the “access result” limitation recited in the relevant claims “flows directly from the ‘access

³⁴ The ALJ rejected Arista’s assertion that “access control” requires “checking the source address and/or destination address of the packet against access control rules that determine whether that source is permitted to send packets to that destination,” noting that the claims are broader than Arista’s narrow interpretation. *Id.* at 116-117.

PUBLIC VERSION

control' limitation such that, failing to satisfy the "access control" limitation *a fortiori* fails to satisfy the "access result" limitation. *Id.* at 25-26 (citing '577 patent at 7:40-46 (claim 1) ("matching matchable information, said matchable information being responsive to said packet label, with said set of access control patterns ... selecting at least one of said matches in response to said priority information, and generating an access result."); Almeroth Tr. at 167:16-19; Black Tr. at 301:8-15).

The MRD finds that, "[u]nlike [] ACL' functionality, filtered port mirroring does not []" but instead "[]" *Id.* at 106 (citing Black Tr. at 303:16-304:3, 304:9-305:12; RX-9001C (Sweeney Witness Statement) at Q/A 306-12). The MRD notes that "[n]owhere does the '577 patent associate 'access control' of a packet with restricting the [], as opposed to restricting the transmission of a packet." *Id.* at 119. Rather, the MRD finds, the "'577 patent is silent on using ACLs to [] a packet" and is equally "silent on using ACLs to [], such that []" *Id.* at 119-120.

The MRD finds that the evidence shows that "persons of ordinary skill in the art view filtered port mirroring as fundamentally different from 'access control.'" *Id.* at 120 (citing Black Tr. at 303:16-304:8). Specifically, the MRD notes the following testimony:

"[F]iltered port mirroring never '[]' and never '[]" (RBr. at 42-43 (citing Tr. (Black) at 305:13-24, 308:20-309:11)). Filtered port mirroring does not,

PUBLIC VERSION

and cannot, determine whether the sender of the original packet is permitted to send that packet to its destination. (Tr. (Almeroth) at 192:8-23 (2018 Hearing); Tr. (Black) at 303:16-304:3, 304:9-305:12; (RX-9001C (Sweeney Witness Statement) at Q/A 306-12). “[

Witness Statement) at Q/A 240.).” (RX-9001C (Sweeney

Id. The MRD finds that “Dr. Almeroth’s, Dr. Sweeney’s and Dr. Black’s explanations of filtered port mirroring is consistent with evidence that, notwithstanding the appearance of ‘access control’ in the term ‘access control lists,’ such lists (abbreviated as ACLs) perform more than just traditional ‘access control.’” *Id.* (citing RDX-9000C-8 (Cisco materials distinguishing between the use of the term ACL and access control)). The MRD further notes that Dr. David Maltz, a [

].” *Id.* at 120-212 (citing JX-9023C (Maltz Decl. at 2, 10)).

The MRD posits that “filtered port mirroring functionality could be designed []” and that such a process “would entail transmission restriction as taught by the ’577 patent.” *Id.* at 121 (citing Black Tr. at 329:13-17). The MRD concludes, however, that filtered port mirroring does not work in that manner in the Redesigned Switches. *Id.* Rather, the MRD finds, the “[] the one described in the ’577 patent’s specification, [].” *Id.* (citing Black Tr. at 305:13-24, 308:20-309:11). The MRD explains that “filtered port mirroring ACLs do not []” but instead “[

PUBLIC VERSION

].” *Id.* at 121-122 (citing Black Tr. at 303:20-306:17, 305:13-24, 329:13-17). The MRD therefore concludes that “the filtered port mirroring functionality of the Redesigned Switches does not practice ‘access control’ as required by each of the asserted claims . . . because the functionality [].” *Id.* at 122 (emphasis in original).

The MRD also performed a claim-by-claim analysis. In particular, the MRD finds that, except for the filtered port mirroring functionality failing to satisfy the “access control” and “access result” limitation, Cisco has shown that the Redesigned Switches practice all of the other limitations of claim 1 of the ’577 patent except for the “making a routing decision” limitation. *Id.* at 124-125. Regarding the limitation “making a routing decision in response to said access result,” the MRD finds that, in addition to failing to satisfy the “access result” limitation, Redesigned Switches using the filtered port mirror functionality decide “[]” not how to route an existing packet. *Id.* at 126.

The MRD further finds that, absent “access control” and “access result,” the Redesigned Switches using the filtered port mirror functionality satisfy the limitations recited in dependent claims 7, 9, and 10. *Id.* at 126-127. The MRD finds, however, that Cisco failed to satisfy the limitation “said routing decision includes permitting or denying access for said packet” recited in dependent claim 15. *Id.* at 127. Specifically, the MRD finds that the port mirroring functionality “[]” but rather “[]” *Id.*

PUBLIC VERSION

2) Discussion

a) Claim Construction: “access control”/“access result”³⁵

Cisco asserts that the MRD’s finding that the filtered port mirroring functionality in the Redesigned Switches does not infringe the relevant claims of the ’577 patent “rests entirely on the [M]RD’s narrow construction of the term ‘access control’ (and the related term ‘access result’)” Cisco Cmm’t. at 20. Cisco notes that, in the Underlying Investigation, the parties agreed to give those terms “their plain and ordinary meaning,” which the Commission interpreted to mean “restricting the transmission of information from specified source devices to specified destination devices.” *Id.* at 23 (citing Inv. No. 945, Comm’n Op. at 22). Cisco argues that the MRD improperly adds “an additional restriction by requiring access control to restrict a packet [], as opposed to [

].” *Id.* (emphasis in original) (citing MRD at 119, 122); *see also id.* at 24-25 (citing ’577 patent at 1:4-9).

Cisco asserts that the language of the relevant claims of the ’577 patent do not require that “access control” and the subsequent “access result” “be applied only to [

], let alone that the ‘access result’ cannot be used to [

], as in the case of port mirroring ACLs.” *Id.* at 23-24

(citing Almeroth Tr. at 120:15–121:8, 128:15–129:1, 190:16-24). Cisco argues that “the claimed requirement that a ‘routing decision’ occur in response to the access result is silent on these

³⁵ Arista does not allege before the Commission that Cisco is precluded from asserting this infringement theory under claim preclusion or any other preclusion doctrine – therefore the Commission does not decide that issue.

PUBLIC VERSION

issues, and is equally applicable to a [

]” *Id.* at 24 (citing Almeroth Tr. at

190:11-24). Nor, Cisco asserts, “does the patent exclude from ‘access control’ restricting a

packet from [], while allowing it []. Rather, a

plain reading covers, for instance, [

]” *Id.* at 25 (citing Almeroth Tr.

at 124:1–125:15, 190:11-24).

As Cisco acknowledges, the Commission construed the term “access control” consistent with its plain and ordinary meaning to mean “restricting the transmission of information from specified source devices to specified destination devices.” Inv. No. 945, Comm’n Op. at 22. Nowhere in that construction, in the claim language, or in the specification of the ’577 patent is there a mention of [] as opposed to packet transmission. As the MRD notes, “in the Underlying Investigation, permitting and denying packet transmission were the only functions Dr. Almeroth and [OUII] identifies as satisfying the ‘access control’ limitation in Arista’s accused products.” MRD at 116. As such, we do not find that the MRD erred in construing the terms “access control” and “access result” or, indeed, that the MRD construes those terms at all instead of simply applying the construction from the Underlying Investigation as was appropriate.

We do note, however, the MRD’s statement that “[i]nherent in the notion of transmission is movement of a thing (in this case, a packet) from a source and to a destination.” MRD at 119 (citing ’577 patent at 1:4 (“[i]n a computer network for transmitting information . . .”).

PUBLIC VERSION

Specifically, the MRD overreaches in additionally stating that “[a] packet leaves and, sometime later, the packet arrives. *Along the way*, its transmission can be restricted.” *Id.* (emphasis added). We agree with Cisco that there is no requirement in the claims or the specification of the ’577 patent that would require “access control to restrict a packet *while* it is being transmitted, as opposed to [].” Cisco Cmm’t. at 23 (emphasis in original).

Cisco also accuses the MRD of improperly comparing the specification of the ’577 patent to the accused products. *Id.* at 26 (citing MRD at 119 (finding that “[n]owhere does the ’577 patent associate ‘access control’ of a packet with restricting the [], as opposed to restricting the transmission of a packet.”)). The MRD, however, appropriately looked to the specification to determine whether the intrinsic evidence supported Cisco’s new interpretation of the scope of the claim language, where the Commission found in the Underlying Investigation that the term “access control” concerned only packet transmission. *See Phillips*, 415 F.3d at 1315 (explaining that “the specification is always highly relevant to the claims construction analysis” and is usually dispositive).

Neither, as Cisco alleges, does the MRD rely on extrinsic evidence to contradict the intrinsic record. Cisco Cmm’t. at 26-27. Rather, the MRD examines the testimony of various experts to understand the backdrop of how filtered port mirroring operates, and then properly compares that understanding with the Commission’s construction of “access control.” MRD at 120-121. Again, the MRD never reconstrues the claim limitation, but merely applies the Commission’s construction, which Cisco did not contest in the Underlying Investigation.

PUBLIC VERSION

b) Filtered Port Mirroring Does Not Infringe the Relevant Claims of the '577 Patent

The operation of the filtered port mirroring function in Arista's Redesigned Switches is undisputed. *See* MRD at 102-103. A packet is selected for mirroring based on an ACL. *Id.* at 102. If the packet is selected, a Redesigned Switch [] to the mirror port. *Id.* If a packet is not selected, []. *Id.* Either way, the original packet []

[] as if the filtered port mirroring feature did not exist. *Id.* The ACL is not used to determine []. *Id.* at 120; *see* Almeroth Tr. at 192:8-

12 (“Q. The port mirroring access list [] never []

[]. Isn't that true, Doctor? A. That's correct. It doesn't have to [in order] to meet the claim.”). Rather, if the packet is mirrored, the packet copy is automatically sent to the mirrored destination port. *Id.* at 118; Cisco Cmm't. at 21 (“as the [M]RD expressly found, a match on a permit rule ‘implicitly *grants access* of the packet copy to the mirrored destination port’”) (emphasis in original); *see also* Black Tr. at 329:7-17 (“Q. And then if I apply an ACL – so that now I'm doing filtered port mirroring . . . If [] . . . a []

[], correct? A. It's true that the []

[], and since it []. *It's not* []

[]. That's one way you could do it, but the Arista product doesn't work that way.”) (emphasis added).

Cisco asserts that the relevant claims of the '577 patent cover “preventing the replication of a packet for transmission to a destination as that necessarily restricts the packet's

PUBLIC VERSION

transmission.” Cisco Cmm’t. at 25 (citing Almeroth Tr. at 124:1–125:15, 190:11-24). However, as discussed above, the “access control” limitation concerns restricting “transmission” of packets, not []. Cisco does not dispute that, [

]. While the MRD states that, as a hypothetical, “[

] . . . would entail transmission restriction as taught by the ’577 patent[,]” the MRD explained immediately after posing the hypothetical that “[t]hat is not how filtered port mirroring works in the Redesigned Switches.” MRD at 121. Cisco’s insistence that transmission restriction can be performed on [] (Cisco Cmm’t. at 24) is based solely on its strained interpretation of the claim language, which does not comport with the Commission’s construction of “access control.” Neither does Cisco dispute that the [

].

Based on the preceding discussion, the Commission adopts the MRD finding that the filtered port mirroring functionality in Arista’s Redesigned Switches does not practice “access control” or, by necessity, the “access result” limitations recited in independent claim 1 of the ’577 patent, and therefore, does not practice any of the relevant claims of the ’577 patent, *i.e.* claims 1, 7, 9, 10 and 15. MRD at 123-128.

Arista argues that the MRD incorrectly finds that, absent the “access control” limitation, the Redesigned Switches would practice the additional limitations recited in dependent claims 9 and 10. Arista Cmm’t. at 83. Because we find that the Redesigned Switches do not infringe

PUBLIC VERSION

independent claim 1, we need not reach this issue. *See Beloit Corp. v. Valmet Oy*, 742 F.2d 1421, 1423 (Fed. Cir. 1984).

c. Indirect Infringement

Cisco asserted that Arista indirectly infringes the relevant claims of the '577 patent by inducing or contributing to the direct infringement of those claims by its customers. MRD at 128. The MRD finds that Cisco has failed to prove the prerequisite of direct infringement. *Id.* at 129-130. Specifically, the MRD finds “no evidence that any customer ever used [

] ACLs’ in [the] Redesigned Switches, notwithstanding Dr. Almeroth’s [].” *Id.* at 129 (citing Black Tr. at 297:20-299:25; RX-9001C (Sweeney Witness) at Q/A 340-45). The MRD further finds that, although “Cisco has demonstrated that [

]” Cisco has not shown that the filtered port mirror functionality practices the relevant claims of the '577 patent. *Id.* 129-130 (citing Almeroth) at 131:8-16, 130:21-131:16; JX-9023C at 9-10; CPX-9101 at line 1709; CX-9201C at 113:12-19; CX-9199C at 142:3-19; CX-9120C at 1-4 []; CX-9113C []; CX-9119C [].

Because the Commission finds that Cisco has failed to show that Arista’s Redesigned Switches directly infringe the relevant claims of the '577 patent using either the [

] ACL” function or filtered port mirroring, there can be no finding of indirect infringement. *Spanston, Inc.*, 629 F.3d at 1353 (noting that a finding of contributory infringement requires a prerequisite finding of direct infringement); *ACCO Brands*, 501 F.3d at

PUBLIC VERSION

1313 (noting a finding of induced infringement requires a prerequisite finding of direct infringement). Accordingly, the Commission has determined not to reach the issue of indirect infringement. *Beloit*, 742 F.2d at 1423.

4. Modification Relief

The MRD recommends that the remedial orders “against Arista be modified or rescinded with respect to” the ’577 patent in keeping with the MRD’s recommended finding that Arista’s Redesigned Switches do not infringe the ’577 patent. MRD at 136. Cisco contends that rescission is not appropriate “because rescission would permit Arista to, *inter alia*, import and sell legacy products found to infringe in the Underlying Investigation.” Cisco Cmm’t. at 37. We agree. The fact that Arista’s Redesigned Products do not infringe does not moot the Commission’s previous finding of violation, which served as the basis for the Commission’s issuance of the remedial orders. Rather, rescission would be justified, for example, in view of the PTO cancelling the relevant claims of the ’577 patent, the patent’s expiration³⁶; or a settlement agreement between the parties that authorized Arista to import switches that practice the relevant claims of the ’577 patent.

Regarding the scope of the modification to the remedial orders, the Commission has explained that, as a result of a modification proceeding to determine whether a redesigned product falls within the scope of an existing remedial order(s), the Commission will “evaluate the claim and, if appropriate, modify the order to specifically exempt the redesigned or new

³⁶ The ’577 patent will expire on June 30, 2018.

PUBLIC VERSION

product.”³⁷ Accordingly, the Commission has determined to modify the remedial orders issued in the Underlying Investigation to exempt the Redesigned Switches running both the Redesigned EOS and Hardened Redesigned EOS. *See supra* at Section III.B.2.

IV. CONCLUSION

The Commission finds that Cisco has failed to show that Arista’s Redesigned Switches running both the Redesigned EOS and Hardened Redesigned EOS infringe the relevant claims of the ’577 patent and declines to reach the issue of whether Arista has indirectly infringed those claims. The Commission has determined to modify the remedial orders issued in the Underlying Investigation to exempt the Redesigned Switches.

The Commission has further determined to suspend the modification proceeding with respect to the ’668 patent. Arista’s motion to stay the modification proceeding as to the ’668 patent is denied as moot in light of the Commission’s prior suspension of the remedial orders with respect to the ’668 patent.

By order of the Commission.



Lisa R. Barton
Secretary to the Commission

Issued: July 12, 2018

PUBLIC VERSION

³⁷“Pilot Program Will Test Expedited Procedures for USITC Modification and Advisory Opinion Proceedings”
(https://www.usitc.gov/press_room/featured_news/pilot_program_will_test_expedited_procedures_usitc.htm)

PUBLIC CERTIFICATE OF SERVICE

I, Lisa R. Barton, hereby certify that the attached **COMMISSION OPINION** has been served upon the following parties as indicated, on **July 12, 2018**.



Lisa R. Barton, Secretary
U.S. International Trade Commission
500 E Street, SW, Room 112
Washington, DC 20436

On Behalf of Complainant Cisco Systems, Inc.:

Adam R. Alper, Esq.
KIRKLAND & ELLIS LLP
555 California Street
San Francisco, CA 94104

- Via Hand Delivery
- Via Express Delivery
- Via First Class Mail
- Other: _____

On Behalf of Respondent Arista Networks, Inc.:

Bert C. Reiser, Esq.
LATHAM & WATKINS LLP
555 Eleventh Street, NW, Suite 1000
Washington, DC 20004

- Via Hand Delivery
- Via Express Delivery
- Via First Class Mail
- Other: _____

UNITED STATES INTERNATIONAL TRADE COMMISSION
Washington, D.C.

In the Matter of

CERTAIN NETWORK DEVICES,
RELATED SOFTWARE AND
COMPONENTS THEREOF (II)

Investigation No. 337-TA-945

NOTICE OF COMMISSION DETERMINATION TO DENY RESPONDENT'S
PETITIONS TO SUSPEND OR TEMPORARILY RESCIND REMEDIAL ORDERS

AGENCY: U.S. International Trade Commission.

ACTION: Notice.

SUMMARY: Notice is hereby given that the U.S. International Trade Commission has determined to deny the petitions of respondent Arista Networks Inc. ("Arista") to suspend or temporarily rescind the limited exclusion order ("LEO") and cease and desist order ("CDO") issued in the above-captioned investigation pending appeal of the Patent Trial and Appeal Board's *inter partes* review final written decisions finding unpatentable the claims of U.S. Patent Nos. 7,224,668 ("the '668 patent") and 6,377,577 ("the '577 patent") that the Commission found to be infringed.

FOR FURTHER INFORMATION CONTACT: Megan M. Valentine, Office of the General Counsel, U.S. International Trade Commission, 500 E Street, S.W., Washington, D.C. 20436, telephone (202) 708-2301. Copies of non-confidential documents filed in connection with this investigation are or will be available for inspection during official business hours (8:45 a.m. to 5:15 p.m.) in the Office of the Secretary, U.S. International Trade Commission, 500 E Street, S.W., Washington, D.C. 20436, telephone (202) 205-2000. General information concerning the Commission may also be obtained by accessing its Internet server at <https://www.usitc.gov>. The public record for this investigation may be viewed on the Commission's electronic docket (EDIS) at <https://edis.usitc.gov>. Hearing-impaired persons are advised that information on this matter can be obtained by contacting the Commission's TDD terminal on (202) 205-1810.

SUPPLEMENTARY INFORMATION: The Commission instituted this investigation on January 27, 2015, based on a Complaint filed by Cisco Systems, Inc. of San Jose, California ("Cisco"). 80 FR 4313-14 (Jan. 27, 2015). The Complaint alleges violations of section 337 of the Tariff Act of 1930, as amended, 19 U.S.C. § 1337, in the sale for importation, importation, and sale within the United States after importation of certain network devices, related software and components thereof by reason of infringement of certain claims of U.S. Patent Nos. 7,023,853; the '577 patent; 7,460,492; 7,061,875; the '668 patent; and 8,051,211. The Complaint further alleges the existence of a domestic industry. The Commission's Notice of Investigation named Arista as respondent. The Office of Unfair Import Investigations ("OUII")

was also named as a party to the investigation. The Commission previously terminated the investigation in part as to certain claims of the asserted patents. Order No. 38 (Oct. 27, 2015), unreviewed Notice (Nov. 18, 2015); Order No. 47 (Nov. 9, 2015), unreviewed Notice (Dec. 1, 2015).

On May 4, 2017, the Commission found a violation of section 337 as to certain claims of the '577 and '668 patents. Notice (May 4, 2017); 82 *Fed. Reg.* 21827-29 (May 10, 2017). Specifically, the Commission issued an LEO prohibiting the unlicensed entry of network devices, related software and components thereof that infringe any of claims 1, 7, 9, 10, and 15 of the '577 patent; and claims 1, 2, 4, 5, 7, 8, 10, 13, 18, 56, and 64 of the '668 patent, and a CDO that prohibits Arista from importing, selling, marketing, advertising, distributing, transferring (except for exportation), soliciting United States agents or distributors, and aiding or abetting other entities in the importation, sale for importation, sale after importation, transfer (except for exportation), or distribution of certain network devices, related software and components thereof that infringe any of claims 1, 7, 9, 10, and 15 of the '577 patent; and claims 1, 2, 4, 5, 7, 8, 10, 13, 18, 56, and 64 of the '668 patent.

On June 1, 2017, Arista filed an emergency petition to modify, suspend, or rescind the remedial orders pending appeal of a May 25, 2017 final written decision of the Patent Trial and Appeal Board ("PTAB") finding unpatentable all of the claims of the '577 patent which form the basis of the Commission's determination of violation. *See Arista Networks, Inc. v. Cisco Systems, Inc.*, Case IPR2016-00303, Final Written Decision (May 25, 2017). Arista also requested a shortened time for Cisco and OUII to file responses to the motion. On June 2, 2017, Cisco opposed Arista's request for a shortened response time.

Also on June 1, 2017, the PTAB issued a final written decision finding unpatentable all of the claims of the '688 patent which form the basis of the Commission's determination of violation. *See Arista Networks, Inc. v. Cisco Systems, Inc.*, Case IPR2016-00309 Final Written Decision (June 1, 2017). Arista filed a second emergency petition to suspend or rescind the remedial orders pending appeal of both the May 25, 2017 and June 1, 2017 final written decisions of the PTAB. *See Arista Networks, Inc. v. Cisco Systems, Inc.*, Case IPR2016-00309 (June 1, 2017). Arista also requested a shortened time for Cisco and OUII to file responses to the motion.

On June 8, 2017, the parties filed a joint stipulation, agreeing that Cisco and OUII would each file a combined response to Arista's petitions by June 12, 2017. Pursuant to the stipulation, Cisco filed a combined response opposing Arista's petitions on June 12, 2017, and OUII filed a response supporting Arista's petitions on the same day. On June 15, 2015, Arista filed a motion for leave to file a reply in support of its petitions. On June 20, 2017, Cisco opposed Arista's motion for leave. On July 18, 2017, Arista filed a supplemental brief.

The Commission has determined to deny Arista's petitions for failing to satisfy the requirements of 19 U.S.C. § 1337(k) and 19 C.F.R. § 210.76. Specifically, the Commission finds that the PTAB's final written decisions do not constitute a changed circumstance such that the remedial orders should be rescinded. The legal status of the claims at issue will not change unless and until the United States Patent and Trademark Office issues a certificate cancelling the claims following the exhaustion of all appeals. 35 U.S.C. § 318 ("If the Patent Trial and Appeal Board

issues a final written decision under subsection (a) and the time for appeal has expired or any appeal has terminated, the Director shall issue and publish a certificate canceling any claim of the patent finally determined to be unpatentable”).

In addition, the Commission denies Arista’s request for a shortened response time in light of the joint stipulation by the parties, and denies Arista’s motion for leave to file a reply in support of its petitions.

The authority for the Commission’s determination is contained in section 337 of the Tariff Act of 1930, as amended (19 U.S.C. § 1337), and in Part 210 of the Commission’s Rules of Practice and Procedure (19 C.F.R. Part 210).

By order of the Commission.

A handwritten signature in black ink, appearing to read "Lisa R. Barton".

Lisa R. Barton
Secretary to the Commission

Issued: June 20, 2017

PUBLIC CERTIFICATE OF SERVICE

I, Lisa R. Barton, hereby certify that the attached **NOTICE** has been served by hand upon the Commission Investigative Attorney, Monica Bhattacharyya, Esq., and the following parties as indicated, on **July 21, 2017**.



Lisa R. Barton, Secretary
U.S. International Trade Commission
500 E Street, SW, Room 112
Washington, DC 20436

On Behalf of Complainant Cisco Systems, Inc.:

Adam R. Alper, Esq.
KIRKLAND & ELLIS LLP
555 California Street
San Francisco, CA 94104

- Via Hand Delivery
- Via Express Delivery
- Via First Class Mail
- Other: _____

On Behalf of Respondent Arista Networks, Inc.:

Bert C. Reiser, Esq.
LATHAM & WATKINS LLP
555 Eleventh Street, NW, Suite 1000
Washington, DC 20004

- Via Hand Delivery
- Via Express Delivery
- Via First Class Mail
- Other: _____

UNITED STATES INTERNATIONAL TRADE COMMISSION
Washington, D.C.

In the Matter of

**CERTAIN NETWORK DEVICES,
RELATED SOFTWARE AND
COMPONENTS THEREOF (II)**

Investigation No. 337-TA-945

**NOTICE OF COMMISSION DETERMINATION TO MODIFY THE REMEDIAL
ORDERS TO SUSPEND ENFORCEMENT AS TO U.S. PATENT NO. 7,224,668**

AGENCY: U.S. International Trade Commission.

ACTION: Notice.

SUMMARY: Notice is hereby given that the U.S. International Trade Commission has determined to modify the limited exclusion order (“LEO”) and cease and desist order (“CDO”) (collectively, “the remedial orders”) issued in the above-captioned investigation to suspend enforcement of those orders as to the claims of U.S. Patent Nos. 7,224,668 (“the ’668 patent”) that the Commission found to be infringed. The Commission has further determined to deny Arista’s motion for stay as moot in view of the suspension of the remedial orders as to the ’668 patent.

FOR FURTHER INFORMATION CONTACT: Megan M. Valentine, Office of the General Counsel, U.S. International Trade Commission, 500 E Street, S.W., Washington, D.C. 20436, telephone (202) 708-2301. Copies of non-confidential documents filed in connection with this investigation are or will be available for inspection during official business hours (8:45 a.m. to 5:15 p.m.) in the Office of the Secretary, U.S. International Trade Commission, 500 E Street, S.W., Washington, D.C. 20436, telephone (202) 205-2000. General information concerning the Commission may also be obtained by accessing its Internet server at <http://www.usitc.gov>. The public record for this investigation may be viewed on the Commission’s electronic docket (EDIS) at <http://edis.usitc.gov>. Hearing-impaired persons are advised that information on this matter can be obtained by contacting the Commission’s TDD terminal on (202) 205-1810.

SUPPLEMENTARY INFORMATION: The Commission instituted this investigation on January 27, 2015, based on a Complaint filed by Cisco Systems, Inc. of San Jose, California (“Cisco”). 80 FR 4313-14 (Jan. 27, 2015). The Complaint alleges violations of section 337 of the Tariff Act of 1930, as amended, 19 U.S.C. § 1337, in the sale for importation, importation, and sale within the United States after importation of certain network devices, related software and components thereof by reason of infringement of certain claims of U.S. Patent Nos. 7,023,853; the ’577 patent; 7,460,492; 7,061,875; the ’668 patent; and 8,051,211. The Complaint further alleges the existence of a domestic industry. The Commission’s Notice of Investigation named Arista Networks Inc. (“Arista”) as respondent. The Office of Unfair Import

Investigations (“OUII”) was also named as a party to the investigation. The Commission previously terminated the investigation in part as to certain claims of the asserted patents. Order No. 38 (Oct. 27, 2015), unreviewed Notice (Nov. 18, 2015); Order No. 47 (Nov. 9, 2015), unreviewed Notice (Dec. 1, 2015).

On June 11, 2016, the Patent Trial and Appeal Board (“PTAB”) of the U.S. Patent and Trademark Office instituted separate *inter partes* review (“IPR”) proceedings concerning the ’577 and ’668 patents. *Arista Networks, Inc. v. Cisco Systems, Inc.*, Case IPR2016-00303 (regarding the ’577 patent); *Arista Networks, Inc. v. Cisco Systems, Inc.*, Case IPR2016-00309 (regarding the ’668 patent).

On May 4, 2017, the Commission found a violation of section 337 as to certain claims of the ’577 and ’668 patents. Notice (May 4, 2017); 82 *Fed. Reg.* 21827-29 (May 10, 2017). Specifically, the Commission issued an LEO prohibiting the unlicensed entry of network devices, related software and components thereof that infringe any of claims 1, 7, 9, 10, and 15 of the ’577 patent; and claims 1, 2, 4, 5, 7, 8, 10, 13, 18, 56, and 64 of the ’668 patent, and a CDO that prohibits Arista from importing, selling, marketing, advertising, distributing, transferring (except for exportation), soliciting United States agents or distributors, and aiding or abetting other entities in the importation, sale for importation, sale after importation, transfer (except for exportation), or distribution of certain network devices, related software and components thereof that infringe any of claims 1, 7, 9, 10, and 15 of the ’577 patent; and claims 1, 2, 4, 5, 7, 8, 10, 13, 18, 56, and 64 of the ’668 patent.

On May 25, 2017, the PTAB issued its final written decision finding claims 1, 7-10, 12-16, 18-22, 25, and 28-31 of the ’577 patent unpatentable based on prior art not presented in the Commission investigation. On June 1, 2017, the PTAB issued its final written decision finding claims 1-10, 12, 13, 15-28, 30, 33-36, 55-64, 66, 67, and 69-72 of the ’668 patent unpatentable based on certain combinations of prior art not presented in the Commission investigation.

On February 14, 2018, the U.S. Court of Appeals for the Federal Circuit summarily affirmed the PTAB’s decision finding the claims of the ’668 patent unpatentable. *Cisco Systems, Inc. v. Arista Networks, Inc.*, Appeal No. 17-2384 (Feb. 14, 2018). The Court issued the mandate on March 23, 2018. *Id.*, Dkt. No. 54. The PTAB’s decision concerning the ’577 is currently still pending before the Court.

On March 15, 2018, Arista filed a motion before the Commission to stay the Commission’s remedial orders as to the ’668 patent. On March 26, 2018, Cisco filed its response stating that it takes no position on and, thus, does not oppose Arista’s motion. OUII did not file a response to Arista’s motion.

The Commission has determined, pursuant to 19 U.S.C. 1337(k)(1) and 19 CFR 210.76(a)(1), to modify the remedial orders to suspend enforcement of those orders with respect to the ’668 patent pending rescission of the orders upon the cancellation of the asserted claims or pending reversal or vacatur of the Federal Circuit’s decision in *Cisco Systems, Inc. v. Arista Networks, Inc.*, Appeal No. 17-2384.

The Commission has further determined to deny Arista's motion as moot in view of the suspension of the remedial orders as to the '668 patent.

The authority for the Commission's determination is contained in section 337 of the Tariff Act of 1930, as amended (19 U.S.C. 1337), and in Part 210 of the Commission's Rules of Practice and Procedure (19 C.F.R. Part 210).

By order of the Commission.

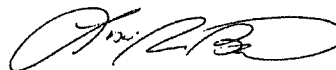
A handwritten signature in black ink, appearing to read 'Lisa R. Barton', enclosed within a large, loopy oval flourish.

Lisa R. Barton
Secretary to the Commission

Issued: April 5, 2018

PUBLIC CERTIFICATE OF SERVICE

I, Lisa R. Barton, hereby certify that the attached **NOTICE** has been served upon the following parties as indicated, on **April 5, 2018**.



Lisa R. Barton, Secretary
U.S. International Trade Commission
500 E Street, SW, Room 112
Washington, DC 20436

On Behalf of Complainant Cisco Systems, Inc.:

Adam R. Alper, Esq.
KIRKLAND & ELLIS LLP
555 California Street
San Francisco, CA 94104

- Via Hand Delivery
 Via Express Delivery
 Via First Class Mail
 Other: _____

On Behalf of Respondent Arista Networks, Inc.:

Bert C. Reiser, Esq.
LATHAM & WATKINS LLP
555 Eleventh Street, NW, Suite 1000
Washington, DC 20004

- Via Hand Delivery
 Via Express Delivery
 Via First Class Mail
 Other: _____

UNITED STATES INTERNATIONAL TRADE COMMISSION

Washington, D.C.

In the Matter of

**CERTAIN NETWORK DEVICES,
RELATED SOFTWARE AND
COMPONENTS THEREOF (II)**

**Inv. No. 337-TA-945
(Modification Proceeding 2)**

**INITIAL DETERMINATION ON VIOLATION OF SECTION 337 IN MODIFICATION
PROCEEDING 2, AND RECOMMENDED DETERMINATION REGARDING
MODIFICATION OF REMEDY**

Administrative Law Judge MaryJoan McNamara

(March 23, 2018)

Appearances:

For the Complainant Cisco Systems, Inc.:

Adam R. Alper, Esq., Sarah E. Piepmeier, Esq., and Robert Kang, Esq. of Kirkland & Ellis LLP, San Francisco, CA

Michael W. De Vries, Esq. of Kirkland & Ellis LLP, Los Angeles, CA

Eric Cheng, Esq. of Kirkland & Ellis LLP, Palo Alto, CA

Deanna Tanner Okun, Esq. and Paul Bartkowski, Esq. of Adduci, Mastriani & Schaumberg LLP, Washington, DC

For the Respondents Arista Networks, Inc.:

Douglas E. Lumish, Esq., Jeffrey G. Homrig, Esq., and Patricia Young, Esq. of Latham & Watkins LLP, Menlo Park, CA

Bert C. Reiser, Esq. of Latham & Watkins, Washington, DC

SUMMARY

On September 27, 2017, Cisco Systems, Inc. (“Cisco”) filed a petition for a modification proceeding in which it sought a determination whether Arista Network, Inc.’s (“Arista”) redesigned products (“Redesigned Switches”)¹ infringe the same patent claims found to infringe in the underlying 945 Investigation (“Underlying Investigation”). (Cisco’s Petition (“Cisco’s Petition”) for a Modification Proceeding Pursuant to Rule 210.76(a)(1) at 1 (Doc. ID No. 624019 (Sept. 27, 2017)).).

Cisco’s Petition also sought to modify and, if necessary, to extend the Limited Exclusion Order (“LEO”) and the Cease and Desist Order (“CDO”) to Arista’s Redesigned Switches that issued against those Arista products found to infringe certain claims of U.S. Patent No. 7,224,668² (“the ’668 patent”) and U.S. Patent No. 6,377,577³ (“the ’577 patent” and, with the ’668 patent, “the Asserted Patents”) in the Underlying Investigation. (*Id.* at 7.).

Accordingly, the Commission instituted this Modification Proceeding 2 on November 1, 2017, “to determine what, if any, modifications to the limited exclusion order and/or the cease

¹ Arista Redesigned Switches consist of device models 7010, 7020 (including 7020R), 7048, 7050 (including 7050X), 7060X, 7150, 7160, 7250X, 7260X, 7280 (including 7280E and 7280R), 7300 (including 7300X), and 7500 (including 7500E and 7500R), running [REDACTED]. (Tr. (Black) at 291:10-292:18; RX-9001C (Sweeney Witness Statement) at Q/A 32-33, 338-39, 365; RBr., App. C.).

² The ’668 patent will expire on August 23, 2025. (Compl. (UI) at 10.).

³ The ’577 patent will expire on June 30, 2018. (Compl. (UI) at 7.).

PUBLIC VERSION

and desist order issued to Arista Networks, Inc. ('Arista') are appropriate.” (Corrected Commission Order at 2 (Doc. ID No. 628211 (Nov. 7, 2018)).

As a result of holding an evidentiary hearing and evaluating evidence, pursuant to 19 C.F.R. §.210.76, this Initial Determination (“ID”) finds, in the absence of the cancellation of the '668 patent, that Arista's Redesigned Switches infringe claims 1, 2, 4, 5, 7, 8, 10, 13, 18, 56, and 64 of the '668 patent. Therefore, at least with respect to the '668 patent, Arista has violated Section 337 of the Tariff Act of 1930, as amended (19 U.S.C. § 1337) by importing, selling for importation, or selling within the United States its Redesigned Switches. Accordingly, this ID recommends that the LEO and CDO issued against Arista in the Underlying Investigation be modified to cover Arista's Redesigned Switches that infringe the '668 patent.

This ID also finds that Arista's Redesigned Switches do not infringe claims 1, 7, 9, 10 and 15 of the '577 patent. Accordingly, this ID recommends that the LEO and CDO issued against Arista in the Underlying Investigation be modified and rescinded to remove any reference to the '577 patent.⁴

While the Federal Circuit Court issued a February 14, 2018 summary affirmance of the Patent Trial and Appeal Board's (“PTAB”)’s decision that the '668 patent is invalid, this decision provides the analysis the Commission requested absent a current, but likely future, cancellation of the '668 patent.

⁴ Arista no longer imports into the United States, sells for importation, or sells in the United States after importation, legacy switches found to infringe in the Underlying Investigation. (RBr. at App. C.).

TABLE OF CONTENTS

INITIAL DETERMINATION ON VIOLATION OF SECTION 337 IN MODIFICATION PROCEEDING 2, AND RECOMMENDED DETERMINATION REGARDING MODIFICATION OF REMEDY..... I

I. PROCEDURAL BACKGROUND..... 1

A. Institution of Modification Proceeding 2..... 1

B. The Parties. 4

1. Complainant Cisco Systems, Inc. 4

2. Respondent Arista Networks, Inc. 5

II. JURISDICTION AND IMPORTATION 6

A. Personal and Subject Matter Jurisdiction..... 6

B. Redesigned Switches 7

C. Ownership of the Asserted Patents and Standing 10

III. THE ASSERTED PATENTS..... 11

A. U.S. Patent No. 7,224,668 (“668 Patent”)..... 11

1. Overview of the ’668 Patent 11

2. Asserted Claims: 1-2, 4-5, 7-8, 10, 13, 18, 55, 56, and 64 15

3. Key Claim Terms for Arista’s Non-Infringement Arguments..... 18

a) Commission’s Statement on “Independent of” 18

b) “Control Plane Port Entity” and “Destined To” “Control Plane Processes” 19

B. U.S. Patent No. 6,377,577 (“577 Patent”)..... 20

1. Overview of the ’577 Patent 20

2. Asserted Claims: 1, 7, 9-10, and 15 23

3. Key Claim Terms for Arista’s Non-Infringement Arguments: “Access Control” and “Access Result” 25

IV. THE ’668 PATENT COVERS ARISTA’S REDESIGNED SWITCHES 26

A. Accused Functionality 26

1. PDP Functionality..... 26

PUBLIC VERSION

2.	PEAC Functionality	35
B.	Infringement Overview	38
1.	PDP Literally Infringes Under the Plain and Ordinary Meaning of “Independent of,” But, in the Alternative, Under Arista’s Construction of that Term, Does Not Infringe Under the DOE	38
a)	Arista’s Argument that PDP Is Not a “Control Plane Port Service” Is Flawed	39
b)	Arista’s Argument that PDP Is Not “Independent of Physical Port Interfaces and Services Applied Thereto” Is Flawed	48
2.	PEAC Literally Infringes Under the Plain and Ordinary Meanings of “Control Plane Processes” and “Destined to” and the <i>Markman</i> Construction of “Control Plane Port Entity,” and, in the Alternative, Under Arista’s Constructions of These Terms, PEAC Infringes Under the DOE	54
a)	Arista’s Argument that Packets Controlled by PEAC Are Not “Destined to” Control Plane Processes Is Flawed	55
b)	Arista’s Argument that PEAC Is Not a “Control Plane Port Entity” Is Flawed	57
c)	Arista’s Argument that PEAC Does Not Provide Access to a “Collection of Control Plane Processes” Is Flawed.....	59
C.	Claim-by-Claim Analysis	63
1.	Independent Claims 1 and 55 of the ’668 Patent Cover the Redesigned Switches	64
2.	All Asserted Dependent Claims of the ’668 Patent Cover the Redesigned Switches	93
a)	Dependent Claim 2 of the ’668 Patent.....	93
b)	Dependent Claim 4 of the ’668 Patent	94
c)	Dependent Claim 5 of the ’668 Patent.....	94
d)	Dependent Claim 7 of the ’668 Patent.....	95
e)	Dependent Claim 8 of the ’668 Patent	95
f)	Dependent Claim 10 of the ’668 Patent.....	95
g)	Dependent Claim 13 of the ’668 Patent.....	96

h)	Dependent Claim 18 of the '668 Patent.....	96
i)	Dependent Claim 56 of the '668 Patent.....	97
j)	Dependent Claim 64 of the '668 Patent.....	97
V.	THE REDESIGNED SWITCHES DO NOT INFRINGE THE '577 PATENT.....	98
A.	Accused Functionality	98
1.	[REDACTED] ACL" Functionality.....	98
2.	Filtered Port Mirroring Functionality	101
B.	Infringement Overview.....	106
1.	Cisco Cannot Indiscriminately Import Evidence of Infringement of the '577 Patent from the Underlying Investigation	107
2.	[REDACTED] ACL" Functionality Does Not Infringe the '577 Patent	109
a)	Arista's Failure to Produce Customer Communications Does Not Give Rise to an Inference That Third-Parties Use [REDACTED] ACLs" in Redesigned Switches	109
b)	Cisco Has Not Proven That [REDACTED] [REDACTED] ACLs" Functionality Infringes	114
3.	Filtered Port Mirroring Does Not Infringe the '577 Patent	114
a)	"Access Control" Restricts Packet Transmission	115
b)	Filtered Port Mirroring Does Not Practice "Access Control"	118
C.	Claim-by-Claim Analysis Reveals That the '577 Patent Covers [REDACTED] [REDACTED] ACL" Functionality But Does Not Cover Filtered Port Mirroring Functionality	123
1.	Independent Claim 1 of the '577 Patent Does Not Cover Filtered Port Mirroring Functionality in Redesigned Switches	123
2.	Dependent Claims 7, 9-10, and 15 of the '577 Patent Do Not Cover Filtered Port Mirroring Functionality in Redesigned Switches	126
D.	Redesigned Switches Do Not Infringe the '577 Patent	128
1.	Arista's Customers Do Not Directly Infringe the '577 Patent.....	129
2.	Arista Does Not Induce or Contribute to Its Customers' Direct Infringement of the '577 Patent	130

PUBLIC VERSION

VI. CONCLUSIONS OF FACT OR LAW 135
VII. RECOMMENDED DETERMINATION ON REMEDY..... 136
VIII. INITIAL DETERMINATION..... 137

APPENDICES

Appendix A: Agreed Upon and Construed Claim Constructions

Appendix B: Chart Listing Arista’s Legacy Switches and Redesigned Switches

ABBREVIATIONS

The following abbreviations are used in this Initial Determination:

Commission Op. (FD)	Commission Opinion announcing Final Determination (FD) of infringement and issuing LEO and CDO in Underlying Investigation
Commission Op. (EP)	Commission Opinion denying Arista's Emergency Petition (EP) to Modify, Suspend, or Rescind Remedial Orders in Underlying Investigation
Compl. (UI)	Complaint in Underlying Investigation
CX	Complainant's exhibit
CDX	Complainant's demonstrative exhibit
CPX	Complainant's physical exhibit
CPBr.	Complainant Cisco Systems, Inc.'s Pre-Hearing Brief
CBr.	Complainant Cisco Systems, Inc.'s Post-Hearing Brief
CBr. (UI)	Complainant Cisco Systems, Inc.'s Post-Hearing Brief in the Underlying Investigation
CRBr.	Complainant Cisco Systems, Inc.'s Post-Hearing Reply Brief
CPSt.	Complainant Cisco Systems, Inc.'s Pre-Hearing Statement
ID	Initial Determination on Violation, Remedy, and Bond in the Underlying Investigation
JX	Joint exhibit
RX	Respondent's exhibit
RDX	Respondent's demonstrative exhibit
RPX	Respondent's physical exhibit
RPBr.	Respondent Arista Networks, Inc.'s Prehearing Brief

PUBLIC VERSION

RBr.	Respondent Arista Networks, Inc.'s Post-Hearing Brief
RRBr.	Respondent Arista Networks, Inc.'s Reply Post-Hearing Brief
RPSt.	Respondent Arista Networks, Inc.'s Pre-Hearing Statement
Tr.	Hearing transcript, January 26, 2018
Markman Order	Order No. 45 (Nov. 5, 2015), Construing the Terms of the Asserted Claims of the Patents at Issue

The following abbreviations for technical and business-related terms are used in this Initial Determination:

ACL	Access Control List (use of ACLs accused on infringing '577 patent, including [] ACLs" and filtered port mirroring
CoPP	Control Plane Policing/Control Plane Protection (legacy feature found to infringe '668 patent in Underlying Investigation)
CP-ACL	Control Plane Access Control List (legacy feature found to infringe '668 patent in Underlying Investigation)
CPU	Central Processing Unit
DoS	Denial of Service
EOS	Arista's "Extensible Operating System" for legacy and Redesigned Switches
EPRM	Erasable Programmable Read-only Memory
PC	Personal Computer
PDP	Port-based Denial-of-service Protection ("redesigned" feature accused of infringing '668 patent)

PUBLIC VERSION

PEAC	Control Plane Process Enforced Access Control (“redesigned” feature accused of infringing ’668 patent)
PiP CoPP	Per-Input Port Control Plane Policing (legacy feature found to infringe ’668 patent in Underlying Investigation)
QoS	Quality of Service
RAM	Random Access Memory
TCAM	Ternary Content Addressable Memory

I. PROCEDURAL BACKGROUND

A. Institution of Modification Proceeding 2

On November 1, 2017, the Commission issued a Notice of Modification Proceeding, naming Cisco as complainant and Arista as respondent. 82 Fed. Reg. 50678 (Nov. 1, 2017).⁵ The Commission did so to determine, “what, if any, modifications to the limited exclusion order and/or the cease and desist order issued to Arista Networks, Inc. are appropriate.” (Corrected Commission Order at 2 (Doc. ID No. 628211 (Nov. 7, 2018)).

The Initial Determination on Violation of Section 337 (“ID”) in the underlying 945 Investigation (“Underlying Investigation”) found that Arista’s products infringed the ’668 and ’577 patents. Specifically, the ID found that Arista’s products infringed claims 1, 2, 4, 5, 7, 8, 10, 13, 18, 56, and 64 of the ’668 patent and that “ACL processing” infringed claims 1, 7, 9, 10, and 15 of ’577 patent). (ID at 91-98, 113 (Doc. ID No. 600435 (Jan. 9, 2017)). The Commission elected not to review the ID’s direct infringement findings that pertain to the ’577 patent, thereby making them part of the Commission’s Opinion. (Commission Op. (FD) at 7 (Doc. ID No. 613184 (June 1, 2017) (reviewed “finding that Arista has indirectly infringed the ’577 patent by importing so-called ‘Imported Components’”).). On June 1, 2017, the Commission affirmed the ID’s infringement findings that pertain to the ’668 patent and issued an LEO barring Arista’s infringing switches from importation, and a CDO that prevented Arista

⁵ The authority for the Commission’s Notice of Modification Proceeding is contained in section 337 of the Tariff Act of 1930, as amended (19 U.S.C. 1337), and in part 210 of the Commission’s Rules of Practice and Procedure (19 CFR part 210), particularly Commission Rule 210.76. (Notice of Modification Proceeding, 82 Fed. Reg. 50678 (Nov. 1, 2017)).

PUBLIC VERSION

from, *inter alia*, selling its infringing switches and software in the United States. (Commission Op. (FD) at 107, 120-26.).

On June 11, 2015, based upon Arista's petitions, the PTAB instituted separate *inter partes* review ("IPR") proceedings against '577 and '668 patents. (Commission Op. on Emergency Petition (EP) at 1 (Doc. ID No. 618018 (July 25, 2017); RX-9315 (IPR2016-00303, Paper 8 at 22, IPR2016-00309, Paper 8 at 2).). On May 25, 2017, the PTAB held invalid all '577 patent claims that Arista had been found to infringe in the Underlying Investigation. (RX-9316 (IPR2016-00303, Paper 53) at 36.). On June 1, 2017, the PTAB held invalid all '668 patent claims that Arista had been found to infringe in the Underlying Investigation. (RX-9317 (IPR2016-00309, Paper 52) at 6-7, 49.).

On June 2, 2017, Arista initiated Modification Proceeding 1. Arista filed an emergency petition with the Commission, seeking to suspend or rescind the remedial orders issued in the Underlying Investigation, pending appeal of the final written decisions of the PTAB regarding the '577 and '668 patents. (Arista Emergency Petition to Modify, Suspend, or Rescind Remedial Orders (Doc. ID No. 613213 (June 1, 2017).). On July 25, 2017, the Commission denied that petition, explaining that "the PTAB final written decisions do not constitute changed conditions of fact or law that warrant temporary rescission of the remedial orders pending appeal of the PTAB decisions." (Commission Op. (EP) at 20.).

In July 2017, Arista submitted a request to Customs and Border Protection ("CBP" or "Customs") under 19 C.F.R. Part 177, seeking approval to import its allegedly redesigned products into the United States. (CBr. at 5.). The Parties engaged in fact discovery at the CBP. Meanwhile, on August 25, 2017, Arista filed an emergency motion with the Federal Circuit,

PUBLIC VERSION

seeking a stay of the Commission's remedial orders. Arista represented to the Federal Circuit that it was "redesigning" its products by "removing the industry-standard features for network security found to infringe and, where possible, replacing them with new features." (Appellant Arista Networks, Inc.'s Emergency Motion to Stay Enforcement of Limited Exclusion Order and Cease and Desist Order at 13, *Cisco Systems, Inc. v. Int'l Trade Comm'n*, C.A. 17-2289, D.I. 29-1 (Aug. 25, 2017)). The Federal Circuit granted-in-part Arista's motion. In its decision, the Federal Circuit permitted Arista to import its allegedly redesigned products unless and until the Commission determines that "such a redesign is barred by the order here under review or by a new or amended order." (Order at 3, *Cisco Sys., Inc. v. Int'l Trade Comm'n*, No. 17-2289 (Fed. Cir. Sept. 22, 2017), ECF No. 57.). In view of this order, Arista withdrew its Part 177 ruling request to Customs. (RPBr. at 4.).

Shortly thereafter, on September 27, 2017, Cisco filed a petition requesting that the Commission "institute a modification proceeding to determine whether Respondent Arista['s] ... purported redesign of its switches as identified in Arista's stay briefing to the Federal Circuit, infringe the patent claims that are the subject of the Limited Exclusion Order ('LEO') and Cease-and-Desist Order ('CDO')." (Cisco's Petition for a Modification Proceeding Pursuant to Rule 210.76(a)(1) at 1 (Doc. ID No. 624019 (Sept. 27, 2017)). That petition was granted on October 27, 2017, instituting this Modification Proceeding 2. (Institution of Modification Proceeding at 1 (Doc. ID No. 626959 (Oct. 27, 2017)).

On February 14, 2018, the Federal Circuit summarily affirmed the PTAB's decision that all asserted claims of the '668 patent are invalid. *Cisco Sys., Inc. v. Arista Networks Inc.*, No. 17-2384, at 2 (Fed. Cir. Feb. 14, 2018) (without an opinion).

PUBLIC VERSION

On February 27, 2018, Arista filed an Emergency Motion to Stay Proceedings and to Stay and Suspend Relief as to the '668 Patent (“Motion to Stay”), requesting a “stay [of] all remedial orders and proceedings concerning the '668 patent until such time as the claims are cancelled or the PTAB’s decision is reversed.” (Motion Docket No. 945-065 (Feb. 28, 2018); Mot. to Stay at 1.) Arista characterized the '668 patent claims asserted in this Modification Proceeding 2 as “virtually certain to be cancelled.” (*Id.* at 1.). Arista presented statistics on the low likelihood that the Federal Circuit will rehear the matter or that the Supreme Court will consider the matter on appeal. (*Id.* at 1, 5-6.). Arista argued that it would be prejudiced in lieu of a stay because Cisco can use its legal right to file for appeal to the Supreme Court to delay the “virtually certain” cancellation of the asserted '668 patent claims by eight (8) months or longer. (*Id.* at 1.).

Arista’s Motion to Stay was denied-in-part and granted-in-part on March 23, 2018. (Order No. 20 (March 23, 2018). Order No. 20 recommends that the Commission modify/rescind the LEO and CDO issued against Arista with respect to the '577 patent, consistent with this ID. The remainder of Arista’s Motion to Stay was denied.

B. The Parties

1. Complainant Cisco Systems, Inc.

Cisco Systems, Inc. (“Cisco” or “Complainant”) is a corporation organized under the laws of California, with its principal place of business in San Jose, California. (Compl. at ¶ 7.). Cisco is an IT company in the business of supplying networking products, among other things. (*Id.* at ¶ 8.).

According to Cisco, it is “the worldwide leading supplier of networking products,” with

research, development, testing, engineering, manufacturing, assembly, packaging, installation, customer service, repair, product support, marketing, and business offices in more than 100 U.S. locations. (CPBr. at 2.). Also, according to Cisco, it employs about half of its more than 70,000 employees in the U.S. (*Id.*). A significant part of Cisco's U.S. operations relate to products that practice Cisco's Asserted Patents. (*Id.*). The technologies covered by Cisco's Asserted Patents arose from Cisco's research and development ("R&D") and the inventive contributions of Cisco's engineers and scientists. (*Id.*). Cisco says that it has made and continues to make significant U.S. based investments in the design and development of products protected by Cisco's Asserted Patents. (*Id.*). Cisco also says that it exploits its patented technologies in the U.S. through various activities, including substantial research and development, engineering, manufacturing, installation, and product and warranty support among others. (*Id.*).

2. Respondent Arista Networks, Inc.

Arista Networks, Inc. ("Arista" or "Respondent," and with Cisco, "the Parties") is a corporation organized under the laws of Delaware, with its principal place of business in Santa Clara, California. (*Id.* at ¶ 12.).

According to Arista, it started from a clean sheet of paper and invested more than person-years building a new, open software architecture that offered customers an alternative to Cisco's traditional closed, enterprise system. (RPBr. at 1.). This was Arista's award-winning Extensible Operating System ("EOS"),⁶ which Arista describes as the most programmable and

⁶ "EOS" is an acronym for "Extensible Operating System." (*See, e.g.*, CX-0221 at CSI-ANI-00128383.000044.). EOS is the interface between the switch and the software that controls the switch

resilient network operating system in the industry. (*Id.*). In 2008, Arista shipped its first EOS-based switch product.⁷ Today EOS powers every Arista switch. (*Id.*). Headquartered in Santa Clara, California, Arista says that it employs more 750 people in the United States and now provides its solutions to more than [REDACTED] customers including such famed companies like [REDACTED], and many others that operate networks in the cloud. (*Id.*). Arista describes its EOS-based switch products as a disruptive technical leap in the market place. (*Id.*). According to Arista's description of its market force, Arista has made a mark and has become a leader in the datacenter and cloud switching market. (*Id.*).

II. JURISDICTION AND IMPORTATION

A. Personal and Subject Matter Jurisdiction

The Commission has jurisdiction over this Modification Proceeding 2. Arista sells for importation, imports, or sells after importation into the United States, Redesigned Switches accused in this Proceeding. (Report of Respondent Arista Networks, Inc. Pursuant to Section V of the Cease and Desist Order at 1 (Doc. ID No. 635174 (Feb. 28, 2018)) (from May 4, 2017 through December 31, 2017, "the quantity in units and the value in dollars of redesigned products that Arista has (i) imported and/or (ii) sold in the United States after importation during the Reporting Period is: [REDACTED] units of covered products valued at \$ [REDACTED]"). Arista responded to the Notice of Modification Proceeding and has fully participated in this

and manages the network. (*Id.*).

⁷ A "switch" is "an intermediate network device that combines some or all of the functions of both a router and a bridge." (JX-0001 at 1:62-64.).

Modification Proceeding 2 by participating in discovery and the January 26, 2018 hearing (“2018 Hearing”) and filing pre-hearing and post-hearing briefs. Arista conceded the Commission’s subject matter and personal jurisdiction in the Underlying Investigation. (ID at 16.).

Accordingly, Arista has submitted to the personal jurisdiction of the Commission, and the Commission has *in rem* jurisdiction over the Redesigned Switches.

B. Redesigned Switches

In response to findings in the in Investigation No. 337-TA-944 and in the Underlying Investigation, that certain of its products infringes, Arista “redesigned” hardware and EOS software used in its switches. (RBr. at 1; Tr. (Black)⁸ at 291:10-292:18 (2018 Hearing); RDX9000C-10; CX-9199C (Sadana⁹ Dep.) at 123:2-14, 129:3-129:25, 177:18-179:18; CPX-9048C (); CPX-9047C (); RX-9337C (); RX-9001C (Sweeney Witness Statement)¹⁰ at Q/A32-33, 338-39, 365.). The primary hardware change was

⁸ At the time of the 2018 Hearing, Dr. John R. Black, Jr. (“Dr. Black”) was an associate professor of computer science at the University of Colorado, Boulder. (Tr. (Black) at 284:15-16 (2018 Hearing)). Dr. Black testified for Arista at the hearing as an expert in the field of computer networking and computer network devices. (RPSt. at 2.). His testimony pertained to non-infringement of “the ’577 patent and Arista’s products.” (Tr. (Black) at 285:12-13 (2018 Hearing)).

⁹ At the time of his deposition, on December 14, 2017, Anshul Sadana (“Sadana”) was Chief Customer Officer at Arista. (CX-9199C at 9:23.). Mr. Sadana was designed by Cisco as a fact witness on “[u]se of Arista’s products and features and communications with Arista customers.” (CPSt. at 2.).

¹⁰ At the time of the 2018 Hearing, Mr. Adam Sweeney (“Mr. Sweeney”) was Vice-President of Software Engineering at Arista. (Tr. (Sweeney) at 196:25-197:3 (2018 Hearing)). Arista designated Mr. Sweeney as a fact witness to provide testimony regarding: “Arista’s response to the Commission’s remedial orders, including the redesign of Arista products; the technical background of the asserted patent(s); non-infringement of the asserted patent(s); the design, structure, function, and operation of Arista’s legacy product(s); and the design, structure, function, and operation of Arista’s redesigned product(s).” (RPSt. at 3-4.). Mr. Sweeney’s witness statement (RX-9001C) was admitted into evidence during the 2018

introducing an [redacted] [redacted] to prevent redesigned versions of EOS software ([redacted]) from supporting infringing functionality. (*Id.*).

Arista's "Redesigned Switches," that is, those that Arista created to comply with the infringement findings of the Underlying Investigation, are denoted as [redacted] hardware.

These Redesigned Switches include only models¹² that have [redacted] [redacted] [redacted] (Tr. (Black) at 291:10-292:18; RX-9001C (Sweeney Witness Statement) at Q/A 32-33, 338-39, 365.). The [redacted] switches run only EOS versions [redacted] ("Redesigned

Hearing. (Tr. (Sweeney) at 197:4-25 (2018 Hearing)).

¹¹ [redacted]

¹² In this Modification Proceeding 2, Cisco accuses Arista 7010, 7020 (including 7020R), 7048, 7050 (including 7050X), 7060X, 7150, 7160, 7250X, 7260X, 7280 (including 7280E and 7280R), 7300 (including 7300X), and 7500 (including 7500E and 7500R) series devices. (CBr. at 7.).

¹³ Dr. Black explained the various [redacted] designations for Arista's switches during the 2018 Hearing. (Tr. (Black) at 291:12-292:18 ("So Your Honor got it exactly right this morning about the [redacted] designation. The oldest [redacted] was [redacted]. And then as response to the 944 there became [redacted] hardware. And in that instance, Arista, whose products are a combination of both hardware and software, ran on legacy, older versions of EOS, and those products had [redacted] ACLs ... At the end of the presidential review period, which I believe was July 4 last year, Arista released [redacted], which could not use the existing versions of EOS. So also, in addition, Arista produced redesigned software to run on its redesigned hardware, and those are EOS revision [redacted] ... you can run the newer software [on pre-redesigned hardware]. If you run it on pre-redesigned hardware, you will get [redacted] [redacted] ACLs, but that combination is not imported and not sold.")).

EOS”) and [REDACTED] (“Hardened Redesigned EOS”).¹⁴ (*Id.*).

As set forth below in Figure 1, Arista’s Redesigned Switches were used and shipped following the expiration of the Presidential Review Period in the Underlying Investigation. (Tr. (Black) at 291:10-292:18; Tr. (Almeroth)¹⁵ at 115:5-117:9 (2018 Hearing)). Arista contends that its [REDACTED] Redesigned Switches with Redesigned EOS started shipping to customers on [REDACTED], and stopped shipping on [REDACTED]. (RBr., App. C.). Arista’s [REDACTED] Redesigned Switches with a Hardened Redesigned EOS have shipped to customers since [REDACTED]. (*Id.*).

¹⁴ As explained in more detail below, Hardened Redesigned EOS was created after Dr. Almeroth found a way to [REDACTED] [REDACTED] ACL” functionality in a Redesigned Switch running Redesigned EOS. (Tr. (Black) at 296:24-297:8; RX-9001C (Sweeney Witness Statement) at Q/A 347-50; Tr. (Almeroth) at 183:3-22 (2018 Hearing)).

¹⁵ At the time of the 2018 Hearing, Dr. Kevin Almeroth (“Dr. Almeroth”) was a professor of computer science at the University of California, Santa Barbara. (Tr. (Almeroth) at 57:16-58:12 (2018 Hearing)). Dr. Almeroth testified for Cisco as an expert in networking device hardware and software, both at the hearing in the Underlying Investigation and 2018 Hearing in this Modification Proceeding 2. (*Id.*; ID at 10 n.10.). His testimony in the 2018 Hearing pertained to “technical background, the ’577 and ’668 patents, infringement by Arista and its alleged re-designed products, and [to] rebut any other issue raised by Arista relating to the ’577 and ’668 patents.” (CPSt. at 1.).

Figure 1: Arista's Redesigned Switches

HW	SV	Products	First Ship Date	Last Ship Date

(RBr., App. C (chart modified to show only Redesigned Switches (see App. B herein for a complete list of Arista's legacy and Redesigned Switches))).

In this Modification Proceeding 2, Cisco has accused software features present in Redesigned EOS and Hardened Redesigned EOS running on Redesigned Switches. Specifically, Cisco has accused the "PDP"¹⁶ and "PEAC"¹⁷ functionalities of infringing the '668 patent. (CBr. at 1-4.). Cisco has accused [redacted] ACLs" (found to infringe the '577 patent in the Underlying Investigation) and filtered port mirroring of infringing the '577 patent. (*Id.*).

C. Ownership of the Asserted Patents and Standing

Each of the Asserted Patents has been assigned to Cisco. The assignments to Cisco have

¹⁶ PDP stands for "Port-based Denial-of-service Protection." (JX-9008C (PDP Spec) at 1.).

¹⁷ PEAC stands for "Process Enforced Access Control." (JX-9009C (PEAC Spec) at 1.).

been recorded with the U.S. Patent and Trademark Office (“PTO”). (ID at 19.). Therefore, Cisco has standing to bring this action against Arista.

III. The Asserted Patents

A. U.S. Patent No. 7,224,668 (“’668 Patent”)

1. Overview of the ’668 Patent

The ’668 patent is entitled “Control Plane Security and Traffic Flow Management.” (JX-9001 (’668 patent) at 1.). The ’668 patent resulted from U.S. Patent Application Serial No. 10/307,154 filed on November 27, 2002. (*Id.*) The ’668 patent issued on May 29, 2007, and names Adrian C. Smethurst, Michael F. Keohane, R. Wayne Ogozaly as the inventors. (*Id.*) The ’668 patent will expire on August 23, 2025. (Compl. (UI) at 10.).

The ’668 patent teaches that routers and other network devices that make up the internet and private networks are critical to the operation of many organizations. (JX-9001 (’668 patent) at 1:6-9.). However, routers are susceptible to denial-of-service (DoS) attacks, in which perpetrators can flood a target router with an extraordinarily high rate of data traffic. DOS attacks clog a router’s ports, deplete a router’s resources, and impede a router’s ability to provide services for its intended purposes. DOS attacks can cause a router to fail. (*Id.* at 1:30-51.).

A router typically separates its functionality into two parts: (1) data plane functions; and (2) control plane functions. (*Id.* at 1:52-54.). The data plane is principally responsible for receiving packets of data at input ports and routing the packets to appropriate output ports. (*Id.* at 1:54-56.). With respect to the data plane, the ’668 patent describes a forwarding path that operates as a *data forwarding plane responsible for per packet processing* (e.g., forwarding). (*Id.* at 3:24-26 (emphasis added).). Data planes typically include a plurality of ports that define

PUBLIC VERSION

physical connection points to the network. Port services typically are then applied to operate on packets entering into or exiting from each individual physical port. (*Id.* at 3:38-41.).

Above the data plane is a network operating system that is responsible for operations in a control plane. (*Id.* at 3:26-27.). In the case of a device such as a router or switch, the *control plane* runs routing, signaling and control protocols that are *responsible for determining the packet forwarding behavior by the data plane*. (*Id.* at 3:26-34 (emphasis added).). Based upon information acquired through its control plane processes, packet forwarding behavior of the data plane elements is thus dictated. (*Id.* at 3:35-37.). DoS attacks are commonly directed at the control plane service functions since their failure is most likely to cause widespread disruptions. (*Id.* at 1:59-63.).

To defend against DoS attacks, administrators can create policies that filter packets arriving from known mischievous sources, deny specific problematic packet types, or limit the rate at which certain packet types are sent from the data plane to the control plane. (*Id.* at 2:24-39.). However, these solutions have drawbacks. There are packet types for which these policies do not provide control plane protection. (*Id.* at 2:45-49.). Moreover, these policies need to be maintained and deployed to every interface in a network, which is not feasible because even a modest network may contain hundreds or thousands of interfaces. (*Id.* at 2:50-58.).

Also, applying these policies at the input ports (and thus to control-plane destined packets as well as non-control plane “transit” traffic) causes significant performance reduction of the router because a port is forced to execute the policies for every packet it receives. (*Id.* at 2:59-3:2.). Similarly, for certain packet types that are destined for both the transit and control planes (i.e. special broadcasts, IPv4 option bits, etc.) it is not possible to set different yet compatible

PUBLIC VERSION

service policies for packets within such a single class.¹⁸ (*Id.* at 3:3-7.). It is also typically not possible in all cases to configure specific classes to identify all control plane destined packet types, since these packet types cannot be readily identified, and current interface policies cannot be configured to control them efficiently. (*Id.* at 3:10-14.).

The '668 patent discloses an improved technique for defending against DoS attacks. (*Id.* at 3:18-21.). For example, the patent discloses a control plane port, which is independent of the physical ports from which packets are received. "Control plane port services" may be applied to packets sent to the control plane port. (*Id.* at 3:43-58.). Control plane processes are implemented as independently executing processes and are *collectively arranged as a single addressable entity*, to provide the ability to better manage control plane traffic. (*Id.* at 3:42-47 (emphasis added).). The full range of traditional port based features applied to the control plane thus replace specialized control plane protection mechanisms. (*Id.* at 8:58-60.).

Figure 1 of the '668 patent below includes an internetworking device **100** and shows the control plane port **140** leading to the control plane **150** at the top of the figure. (*Id.* at 4:24-25.).

¹⁸ The '668 patent treats "classes" as categories. (*Id.* at 4:3-5 ("A class of packets to be controlled are defined (such as Telnet SYN) and policies are attached to such class.")).

Figure 2: '668 patent's "block diagram overview of an internetworking device having an aggregate control plane services function"

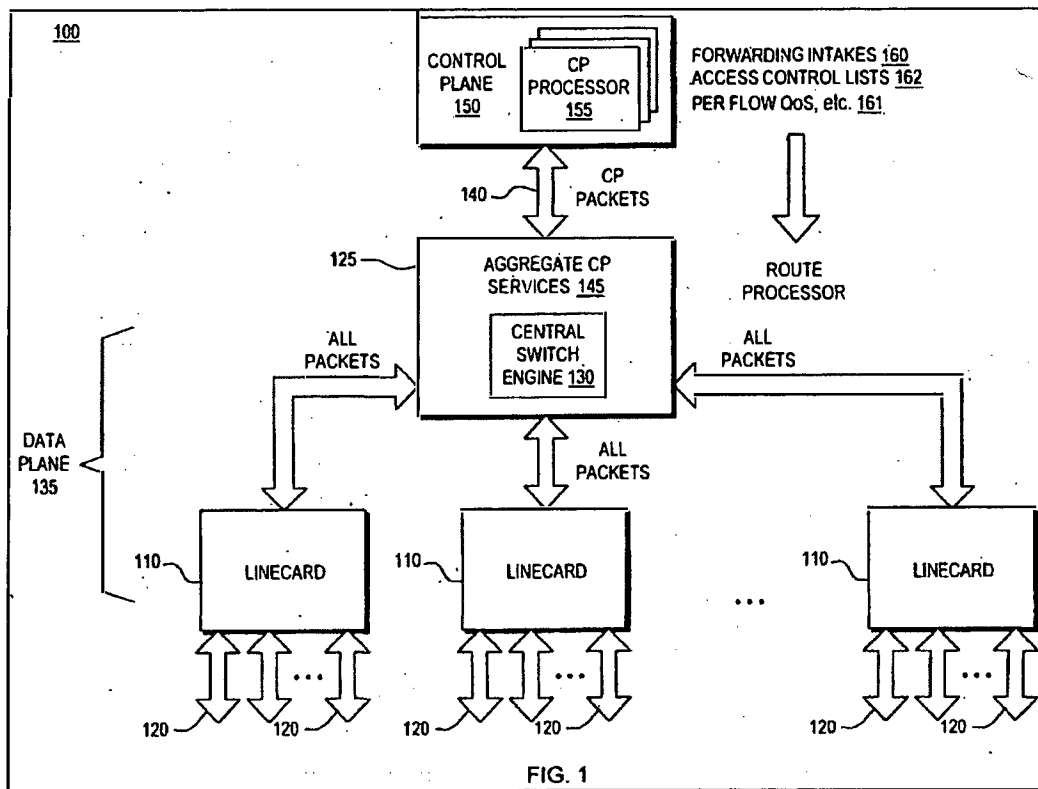

(Id. at Fig. 1.).

Packets that would have been destined to specific control plane processes are destined to the single control plane port. (Id. at 3:48-54.). The control plane port 140 may or may not be a single physical port; for example, it may be a virtual address through which packets travel or are routed from the data plane 135 to the control plane 150. (Id. at 5:1-4 (emphasis added)).

Packets destined to the control plane port can be identified in a number of ways, such as by using information implicit to specific packets, the result of a routing or switching decision, or by considering other control or configuration information. (Id. at 3:59-64.). Candidate packets for

control planes services 145 may involve a variety of control packet types that are destined to the control plane 150 even if they do not specifically address the control plane. (*Id.* at 8:31-34.).

It is advantageous for administrators to apply a set of control plane services to the single control plane port (which would affect packets entering and exiting each of the control plane processes). (*Id.* at 3:54-58, 4:5-12.). For example, one policy may be to rate limit packets of the type “Telnet SYN” to a specific rate that is a tolerable rate determined through a specific hardware configuration, and the administrator can then apply this limit to the single control plane port rather than modifying the configuration on all ports. (*Id.* at 4:6-10.).

In one embodiment, a central switch engine 130 typically performs high speed Input and Output Services (IOS) for port interfaces such as the line cards 110. (*Id.* at 5:34-36.). An important aspect of the central switch engine 130 is that all packets destined to the control plane 150 must pass through the central switch engine 130 prior to being routed to the functions in the control plane 150, such that the *central switch engine 130 can be utilized to implement aggregate control plane protection.* (*Id.* at 5:36-41 (emphasis added).). For example, in Figure 1 of the '668 patent (Figure 2 above), the central switch engine 130 executes the input port services for the control plane port 140 making routing decisions for packets designated for the control plane 150. (*Id.* at 6:51-54.).

2. Asserted Claims: 1-2, 4-5, 7-8, 10, 13, 18, 55, 56, and 64

Cisco contends that Arista Redesigned Switches infringe claims 1-2, 4-5, 7-8, 10, 13, 18, 55, 56, and 64 of the '668 patent. (CBr. at 7.). Claims 1 and 55 are the only independent claims. (JX-9001 ('668 patent) at 1:17-41, 13:11-34.). Claim 1 is drawn to a device claim, while claim 55 is drawn to a computer readable storage medium. (*Id.*) The asserted claims are recited

below, with italics used to indicate where the Parties dispute whether claim limitations are satisfied by the Redesigned Switches.

1. An internetworking device comprising:
 - a. a plurality of physical network interface ports, each for providing a physical connection point to a network for the internetworking device, the ports being configurable by control plane processes;
 - b. port services, for operating on packets entering and exiting the physical network interface ports, the port services providing an ability to control and monitor packet flows, as defined by control plane configurations;
 - c. a control plane, comprising a plurality of internetworking control plane processes, the control plane processes for providing high-level control and configuration of the ports and the port services;
 - d. wherein:
 - i. *a control plane port entity provides access to the collection of control plane processes, so that a set of control plane port services can be applied thereto; and*
 - ii. *the control plane port services operate on packets received from specific, predetermined physical ports and destined to the collection of control plane processes in a way that is independent of the physical port interfaces and services applied thereto.*
2. A device as in claim 1 wherein the control plane processes are accessible through a control plane port on the internetworking device, such that control plane packets originating at a plurality of physical ports and destined to one of a plurality of control plane processes are first processed through the control plane port, rather than to individual control plane processes.
4. A device as in claim 3 wherein the control plane port services are applied after a transit packet forwarding decision is made.
5. A device as in claim 3 wherein Layer 2 control packets are identified and forwarded to the control plane port.

PUBLIC VERSION

7. A device as in claim 1 wherein the control plane processes are distributed across multiple processors.

8. A device as in claim 1 wherein the control plane port services are implemented as an aggregate control plane function applied to packets received from multiple physical ports on the internetworking device.

10. A device as in claim 1 wherein the control plane port services are implemented as distributed control plane port services, and wherein the distributed control plane port services are applied only to the packets received from the specific, pre-determined physical ports.

13. A device as in claim 10 wherein one or more distributed switch engines deliver packets to the control plane port.

18. A device as in claim 1 where in control plane port services are controlled and configured as unique entity, separate from physical port services.

55. A computer readable storage medium containing instructions readable by a computer to configure the computer to perform a method for processing packets in an internetworking device comprising:

a. configuring a plurality of physical network interface ports, each port for providing a physical connection point into a network, and the ports being configurable by control plane processes;

b. executing port services on packets entering and exiting the physical network interface ports, the port services for controlling and monitoring packet flows as defined by control plane configurations;

c. executing a plurality of control plane processes, the control plane processes providing high level control and configuration of the ports and port services, and additionally comprising the steps of:

i. *accessing the collection of control plane processes as a control plane port entity, so that a set of control plane port services are applied thereto as a set; and*

ii. *operating on packets received from specific, predetermined physical ports and destined to the collection of control plane processes in a way that is independent of the individual physical port interface configuration and port services applied thereto.*

56. A medium as in claim 55 wherein the control plane port processes packets originating at a plurality of physical ports, the method additionally comprising:

passing packets through the control plane port, rather than directly from the physical ports to individual control plane processes.

64. A medium as in claim 55 additionally comprising:

applying distributed control plane port services only to the packets received from the specific, pre-determined physical ports.

(*Id.* at 9:18-14:17.).

3. Key Claim Terms for Arista's Non-Infringement Arguments

a) Commission's Statement on "Independent of"

The proper construction of the claim term "independent of" is contested by Arista and Cisco in this Modification Proceeding 2. (CBr. at 17-21; RBr. at 19-24.). Whether or not the PDP functionality within Arista's Redesigned Switches directly infringes the '668 patent turns, at least in part, on whether PDP provides control plane port services that operate "independent of" physical ports and services applied thereto. Arista's argument, in essence, is that PDP is a physical port service and thus cannot operate "independent of" physical ports and services applied thereto. (RBr. at 19-24.).

The *Markman* Order in the Underlying Investigation explained that "[t]here is nothing in the plain language of the asserted and unasserted claims ... to suggest that 'independent of' must only mean 'separate from,'" as Arista had suggested. (*Markman* Order at 61.). During the hearing in the Underlying Investigation, Cisco argued that "applied after ... the control plane packets exit the physical ports and services applied thereto" satisfied the plain and ordinary meaning of "independent of." (CBr. (UI) at 26.). Agreeing with Cisco's position, the ID found

that Arista's PiP CoPP functionality satisfied that claim limitation, and therefore infringed. (ID at 201 (citing Cisco's Post-Hearing Brief)).

In its review of the ID, in a section that addresses the '668 patent, the Commission provided additional guidance on the meaning of "independent of." (Commission Op. at 88-106.). Laying a contextual foundation, the Commission noted that the asserted claims "require, not only that the 'control plane port services' be applied to packets destined to the control plane, but to the 'control plane port entity.'" (*Id.* at 95.). The Commission stated, "[i]n essence, the problem is that, in prior art devices, all packets entering a port, whether data packets or control plane packets, were subjected to all of the services configured on that port. As a result, and consistent with the IDs finding [and, notably, borrowing the same language that the ID borrowed from Cisco's Post-Hearing Brief in the Underlying Investigation]," the Commission found that "the limitation 'independent of' means that 'control plane port services,' which are applied to a 'control plane port entity' ... 'are applied after the physical ports and services applied thereto.'" (*Id.* at 98.) (emphasis added). The Commission continued, "the primary focus of the invention is, as Cisco notes, to prevent applying configurations to a physical port that will affect both control plane and transit packets." (*Id.* at 101.).

b) "Control Plane Port Entity" and "Destined To" "Control Plane Processes"

According to Arista, while PDP is a physical port service, PEAC operates in a completely different part of the packet pipeline, as part of a . Consequently, there is no dispute that PEAC is "independent of" physical ports and services applied thereto. (RBr. at 24-

32.). However, Arista argues that PEAC does not provide a singular “control plane port entity” because there are many, [REDACTED]¹⁹ of PEAC, each operating within a separate [REDACTED]. (*Id.* at 29-30.). Arista also contends that PEAC operates on control plane packets that have [REDACTED] and thus are not “destined to” control plane processes. (*Id.* at 25-29.). Finally, Arista argues that each [REDACTED] of PEAC operating within an [REDACTED] restricts access of control plane packets to a [REDACTED] control plane process, not [REDACTED]. (*Id.* at 30.).

B. U.S. Patent No. 6,377,577 (“’577 Patent”)

1. Overview of the ’577 Patent

The ’577 patent is entitled “Access Control List Processing in Hardware.” (JX-9002 (’577 patent) at 1.). The ’577 patent resulted from U.S. Patent Application Serial No. 09/108,071, filed on June 30, 1998. (*Id.*) The ’577 patent issued on April 23, 2002, and names Andreas V. Bechtolsheim and David R. Cheriton as the inventors. (*Id.*) The ’577 patent will expire on June 30, 2018. (Compl. (UI) at 7.).

The ’577 patent teaches that a network device,²⁰ such as a router, in a computer network may restrict messages “from being transmitted from selected source devices to selected destination devices ... this form of restriction is known as ‘access control.’” (JX-9002 (’577 patent) at 1:4-8.). One technique for implementing access control involves preparing an access

¹⁹ “[REDACTED],” as used herein, refers to [REDACTED] of PEAC source code embedded within a [REDACTED] [REDACTED] alongside source code used for other [REDACTED] tasks, such as source code for the [REDACTED] the [REDACTED] and the substantive processing of [REDACTED].

²⁰ Network devices can include routers, switches, and firewalls. (*See, e.g.*, JX-9002 (’577 patent) at 1:6-7.).

PUBLIC VERSION

control list (“ACL”). An ACL includes one or more entries of access control specifiers. As the name indicates, an access control specifier specifies whether the transmission of information is permitted or prohibited from a certain sender (or a range of senders) to a certain destination (or a range of destinations, such as a subnetwork). (*Id.* at 1:10-15.). For example, an access control specifier may specify an Internet Protocol address of a sender or destination, a prefix or subnet address for a group of senders or destinations, or a port number used by the sender or the destination to transmit information. (*Id.* at 1:15-20.).

To implement access control, an ACL is provided to a network device, such as a router. (*Id.* at 1:23-27.). As packets²¹ of information arrive at a router for transmission, the router checks the packets against the access control specifiers that were provided in the ACL to determine whether the sender of the packet and the destination of the packet are permitted based on the access control specifiers. (*Id.* at 1:6-10.). If permitted, the router forwards the packet to the appropriate output for transmission to the destination. (*Id.* at 1:6-15.). If prohibited, the router denies transmission of the packet. (*Id.* at 1:4-6.).

²¹ Messages exchanged in a computer network are in the form of packets of information. (JX-0002 ('577 patent) at 1:6-10.). A packet includes a header containing the identifications of the source device and the destination device. (*Id.* at 2:41-43, 4:1-4, Fig. 2.).

Figure 3: '577 Patent's "block diagram of a system for access control list processing"

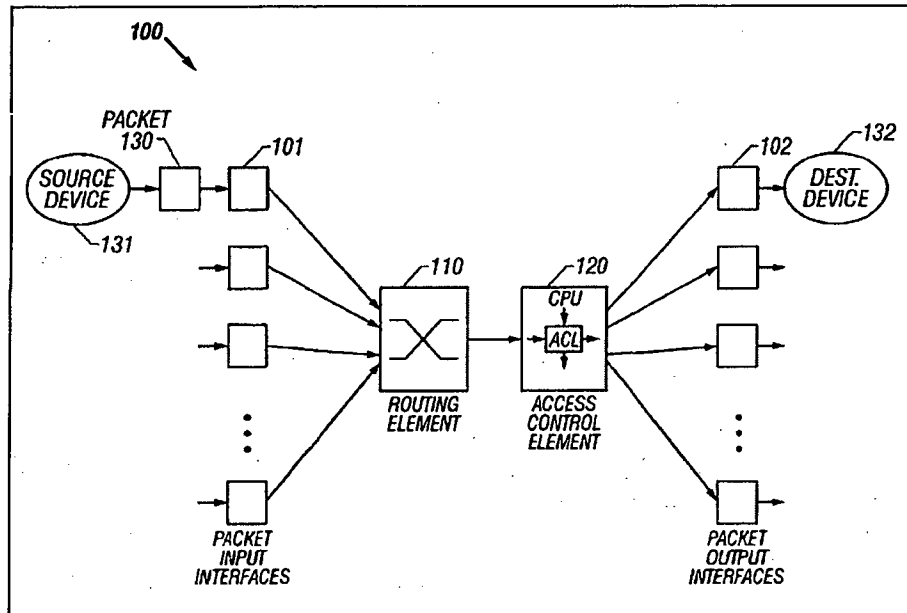

(JX-9002 ('577 patent) at Fig. 3.).

The '577 patent recognizes that the prior art implementations of processing packets to enforce access control according to an ACL are slow and processor-intensive. (*Id.* at 1:28-32.). The slowness is exacerbated when access control is implemented using software processing instead of hardware processing. (*Id.* at 1:32-35.). Moreover, if the ACL includes numerous entries of access control specifiers, such as when the requirements for access control are complex, more time is required to process the access control specifiers for each packet. (*Id.* at 2:9-17.). For example, wires in computer networks can transmit about 1.5 million to hundreds of millions of packets per second. (*Id.* at 2:20-24.). It would be desirable for routers to process packets at these rates. (*Id.* at 2:24-25.). However, the speed at which routers can implement

access control based on large ACLs can be as slow as about 10,000 packets per second. (*Id.* at 2:18-19.). Such speeds are unacceptably low. (*Id.* at 2:25-26.).

To address the slowness problem, the '577 patent teaches hardware processing of ACLs, which is faster than software processing, and teaches processing the access control specifiers in parallel, which is faster than sequential processing. (*Id.* at 2:7-29, 7:40-44.). First, access control specifiers from an ACL are recorded in a content-addressable memory ("CAM") of a router. (*Id.* at 2:29-32, 40-41.). When a packet arrives at the router, it extracts certain information from the header, such as the source IP address, the destination IP address, and the port number. (*Id.* at 2:33-34, 41-43.). Then the router attempts to match the packet header information to all the access control specifiers stored in the CAM in parallel. (*Id.* at 2:34-35, 43-44, 7:40-42.). One or more successful matches are sent to a priority selector, which selects the match with the highest priority, and the selected match determines whether to permit or deny the transmission of the packet. (*Id.* at 2:44-49.). These steps are performed in hardware without the need for software processing, thus increasing the speed at which access control is enforced. (*Id.* at 2:28-30, 38-40, 49-50.).

2. Asserted Claims: 1, 7, 9-10, and 15

Cisco contends that Arista's Redesigned Switches infringe claims 1, 7, 9-10, and 15 of the '577 patent.²² (CBr. at 34.). These are method claims that recite steps²³ for making a routing

²² Cisco contends that Arista indirectly infringes the asserted claims of the '577 patent by contributing to and inducing performance (i.e., direct infringement) of the patented method by Arista's customers. (CBr. at 47-49.). Indirect infringement, both contributory and induced, requires that the infringer act with knowledge of the patent(s)-at-issue and intent to bring about the desired result, which is direct

PUBLIC VERSION

decision for a packet by matching in parallel a packet label derived from the packet with access control patterns stored in memory. (JX-9002 ('577 patent) at 7:34-8:28.). The asserted claims are recited below with italics used to indicate where the Parties dispute whether claim limitations are satisfied by the Redesigned Switches.

1. A method, including the steps of maintaining a set of *access control* patterns in at least one associative memory;

receiving a packet label responsive to a packet, said packet label being sufficient to perform *access control* processing for said packet;

matching matchable information, said matchable information being responsive to said packet label, with said set of *access control* patterns in parallel, and generating a set of matches in response thereto, each said match having priority information associated therewith;

selecting at least one of said matches in response to said priority information, and generating an *access result* in response to said at least one selected match; and

making a routing decision in response to said *access result*.

3. A method of as in claim 1, including the step of performing at least two of said steps of receiving, matching, selecting, and making a routing decision, in parallel using a pipeline technique.

4. A method as in claim 1, wherein said associate memory includes a ternary content-associative memory.

infringement, often by a customer. *Commil USA, LLC v. Cisco Sys., Inc.*, 135 S. Ct. 1920, 1926, 1928 (2015).

²³ A process or method claim is infringed only if each step of the claimed method is performed. *Muniauction, Inc. v. Thomson Corp.*, 532 F.3d 1318, 1328 (Fed. Cir. 2008). The mere sale or importation of an apparatus capable of performing the patented method does not constitute infringement. *Joy Techs., Inc. v. Flakt, Inc.*, 6 F.3d 770, 775 (Fed. Cir. 1993).

9. A method as in claim 1, wherein said priority information for each said *access control* pattern is responsive to a position of said *access control* pattern in a memory.

10. A method as in claim 1, wherein said priority information includes a position in said associative memory, and said step of selecting includes choosing a first one of said matches.

15. A method as in claim 1, wherein said routing decision includes permitting or denying access for said packet.

(*Id.*).

3. Key Claim Terms for Arista's Non-Infringement Arguments: "Access Control" and "Access Result"

According to Cisco, Arista infringes the '577 patent because its Redesigned Switches contain filtered port mirroring functionality, and a [REDACTED] ACL" functionality the latter of which was found to infringe in the Underlying Investigation. Arista does not dispute that its [REDACTED] ACL" functionality would infringe if used by Arista's customers. (RBr. at 33 ("In the underlying investigation, the Commission found that Arista's [REDACTED] access control functionality infringed the '577 patent.")). Instead, Arista argues that this functionality was [REDACTED] and thus cannot be used by customers directly to infringe the '577 patent. (*Id.*).

Arista's non-infringement arguments for filtered port mirroring turn on the correct interpretation of "access control" and a corresponding "access result." (RBr. at 41-43.). Arista contends that "access control" requires the restriction of packet transmission. (*Id.* at 41.). Arista argues that filtered port mirroring is fundamentally different from "access control," such that the former restricts the [REDACTED] of packets, not their [REDACTED]. (*Id.* at 42.). The "access result" limitation flows directly from the "access control" limitation. If the Redesigned

Switches do not satisfy the “access control” limitation, *a fortiori*, they also do not satisfy the “access result” limitation. (JX-9002 (’577 patent) at 7:40-46 (claim 1) (“matching matchable information, said matchable information being responsive to said packet label, with said set of access control patterns . . . selecting at least one of said matches in response to said priority information, and generating an access result.”); Tr. (Almeroth) at 167:16-19 (2018 Hearing); Tr. (Black) at 301:8-15.).

IV. The ’668 Patent Covers Arista’s Redesigned Switches

A. Accused Functionality

The Redesigned Switches run Redesigned EOS or Hardened Redesigned EOS, each of which offers the following control plane protection functionalities: (1) PDP; and (2) PEAC. (RBr., App. C (chart of hardware/software combinations for Arista’s legacy switches and Redesigned Switches); Tr. (Almeroth) at 69:17-70:1, 70:8-15, 75:2-19 (2018 Hearing); CDX-9004C-35A-36; JX-9020 at 2597, 1356; CX-9192C at 69:13-16; CX-9006C at 8; CX-9003C at 1.).

1. PDP Functionality

PDP stands for “Port-based Denial-of-service Protection.” (JX-9008C (PDP Spec) at 1.).

PDP [redacted] packets, including those [redacted]

[redacted]²⁴ (*Id.* at 2-4.). PDP is designed so that every PDP [redacted]

[redacted] action. (JX-9008C (PDP Spec) at 1; Tr. (Almeroth) at 80:17-81:5

²⁴ For example, PDP’s [redacted] class is for packets [redacted]. (Tr. (Almeroth) at 71:22-72:5; JX-9008C at 2.).

(2018 Hearing); RX-9001C (Sweeney Witness Statement) at Q/A 37, 65.). By policing control plane packets using a technique known as rate limiting,²⁵ PDP can protect the control plane of a Redesigned Switch from getting flooded with packets during a denial of service (DoS) attack.

(Tr. (Almeroth) at 65:23-66:7 (2018 Hearing); JX-9008C (PDP Spec) at 1.). PDP [redacted]

[redacted], including those [redacted], using the [redacted]

in the [redacted], making its [redacted] based on [redacted]

[redacted]

of the [redacted] device. (Tr. (Almeroth) at 65:23-66:17, 79:10-80:5 (2018 Hearing); JX-9008C (PDP Spec) at 1.).

Figure 4: Cisco's Depiction of PDP

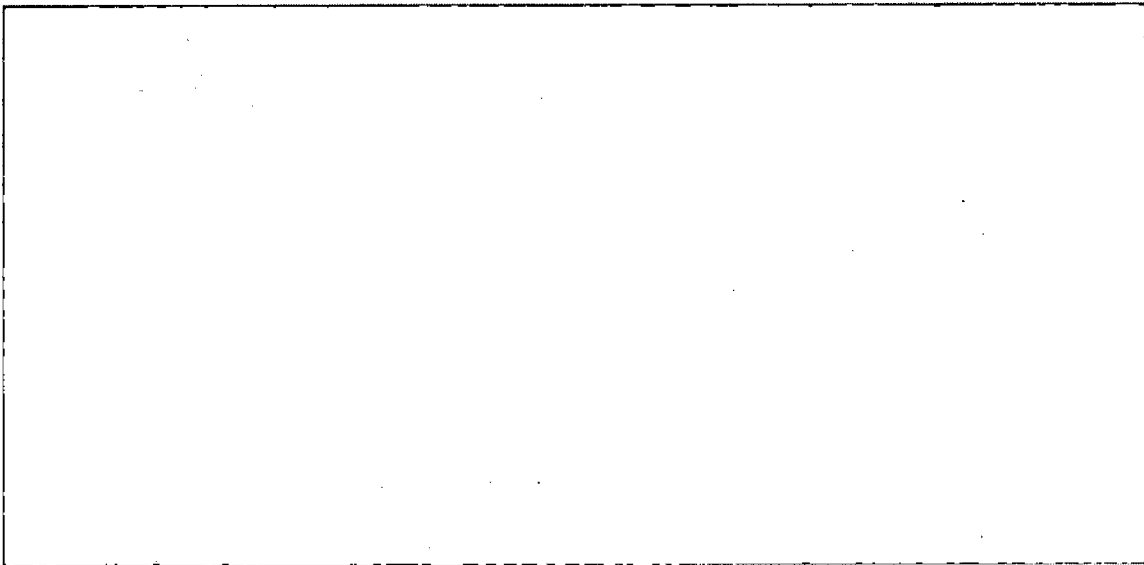

²⁵ The '688 patent discusses rate limiting. (JX-9001 ('668 patent) at 2:33-39 (“Hardware based rate limits can then be implemented as a throttling mechanism for the specific packet types so identified. For example, packets of the type SYN can be specifically rate limited on a particular port or other hardware, at least preventing the rate at which such packets are sent to the control plane.”).).

(CDX-9004C-23A (presented by Dr. Almeroth during the 2018 Hearing)).

After PDP sorts packets into classes, packet classes that map to a policing action, including those containing control plane packets in some instances, are policed or rate limited by a “policer” that is [redacted]. (Tr. (Almeroth) at 88:4-17, 88:23-89:22, 157:23-158:25 (2018 Hearing); Tr. (Snoeren) at 260:1-23 (2018 Hearing).²⁶). The policing logic [redacted] information to update the [redacted], compares the [redacted] to the [redacted] [redacted] result. (JX9007C at 116 ([redacted] switch) (“The Policer stage [redacted]”); CX-9019C at 39 ([redacted] switch) (policing logic reads the [redacted]); CX-9013C at 21 ([redacted] switch) (“The [redacted] engine updates the [redacted] rates”); CX-9012C at 281 ([redacted] switch) (“[redacted] is performed on [redacted]”). Policing results are stored in the packet’s [redacted] information this is the information that [redacted] [redacted] packet.” (Tr. (Snoeren) at 220:15-25, 228:8-229:3 (2018 Hearing)).

²⁶ At the time of the 2018 Hearing, Dr. Mark Alexander Connell Snoeren (“Dr. Snoeren”) was a Professor at the University of California in San Diego, focusing on networking and distributed systems. (Tr. (Snoeren) at 199:11-200:9 (2018 Hearing)). Arista designated Dr. Snoeren as an expert witness to provide testimony with regard to: “asserted patent(s); non-infringement of the asserted patent(s); the design, structure, function, and operation of Arista’s legacy products; the design, structure, function, and operation of Arista’s redesigned product(s); prior art products and designs; and/or any other issues for which Arista bears the burden of proof.” (RPSt. at 3.). During the 2018 Hearing, Dr. Snoeren testified that he was retained by Arista to evaluate Cisco’s allegations with respect to the ’668 patent, without mentioning other duties performed for Arista. (Tr. (Snoeren) at 200:6-9 (2018 Hearing)).

PUBLIC VERSION

Aside from [] packets in this fashion, PDP does not otherwise [] the packets. (Tr. (Snoeren) at 271:25-272:12 (2018 Hearing)). Both Dr. Almeroth and Dr. Snoeren agree that packets [] by PDP to be [] are actually [] later in the pipeline. (Tr. (Almeroth) at 151:16-18 (2018 Hearing); Tr. (Snoeren) at 272:5-8 (2018 Hearing)). This happens when the Redesigned Switches [] policing results and make a [] [] concerning the packet. (RX-9001C (Sweeney Witness Statement) at Q/A 59; Tr. (Snoeren) at 256:24-257:8 (2018 Hearing)).

According to Cisco's expert, Dr. Almeroth, in at least certain Redesigned Switches, packet [] occurs at [], "which undisputedly is located after the physical ports and services applied thereto." (Tr. (Almeroth) at 85:17-86:5 (2018 Hearing); JX-9008C at 13 ([] packet pipeline); JX-9022C at 47 [] specification); CX-9043 at 4, 11-12 ([] specification); CX-9009C at 352-53 ([] chip specification); CX-9019C at 1671-73, 1708, 1771, 1923-30 ([] specification)). However, Arista's expert, Dr. Snoeren contends that packets are []." (Tr. (Snoeren) at 223:14-25 (2018 Hearing)). Where Redesigned Switches [] packets is relevant to Arista's non-infringement argument that PDP does not operate "after physical ports and services applied thereto." (RBr. at 19-24.).

Each Party cites to JX-9008C (PDP Spec), entitled "PDP: [] []",²⁷ in support of its position on how PDP operates. (CBr. at 7-11; RBr. at 9.). The

²⁷ This PDP Spec is undated. (JX-9008C.).

PDP Spec illuminates the [redacted] of the Redesigned Switches, and where and how PDP operates within that [redacted], using text and diagrams, some of which are reproduced below. (JX-9008C (PDP Spec) at 1-26.).

In the Introduction section, the document explains that “[e]ach physical port of a switch running EOS applies [redacted]. Until configured otherwise, EOS uses a [redacted]. The administrator of the switch can assign [redacted] when desired. If the [redacted] is [redacted] a port, the port reverts to using [redacted] for the switch.” (JX-9008C (PDP Spec) at 1.).

PDP policies use [redacted] [redacted] (JX-9008C (PDP Spec) at 1-2.). “These [redacted] both: (1) fields [redacted]; and (2) attributes associated with [redacted] [redacted] (*Id.*). “All of the assigning, policing, and counting of packets by PDP takes place before [redacted] is made by the [redacted], and so before the packet is [redacted] [redacted].” (*Id.*).

Figure 5: Architecture Used by Arista for [] Family of Redesigned Switches

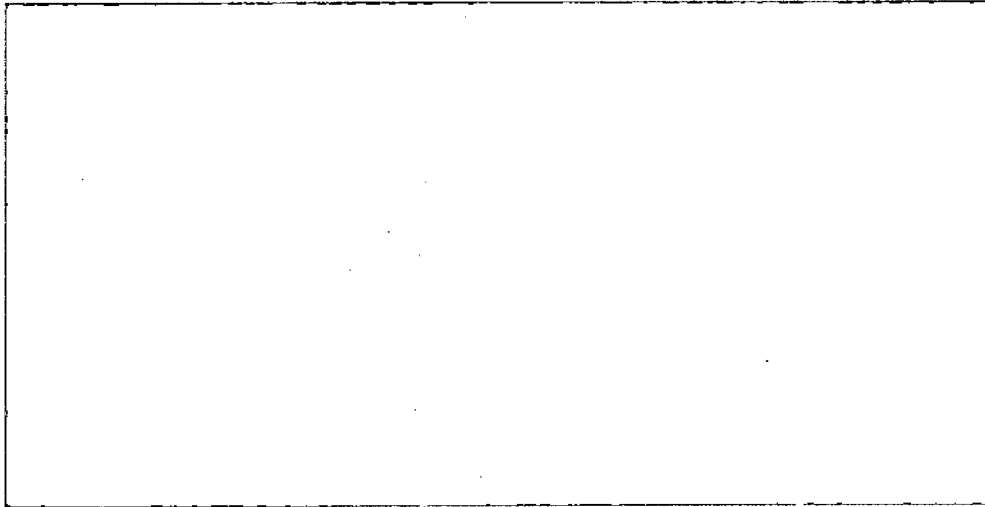

(*Id.* at 12 (found in PDP Spec, indicating that PDP is a service [])).

Figure 6: Architecture Used by Arista for [] Family of Redesigned Switches

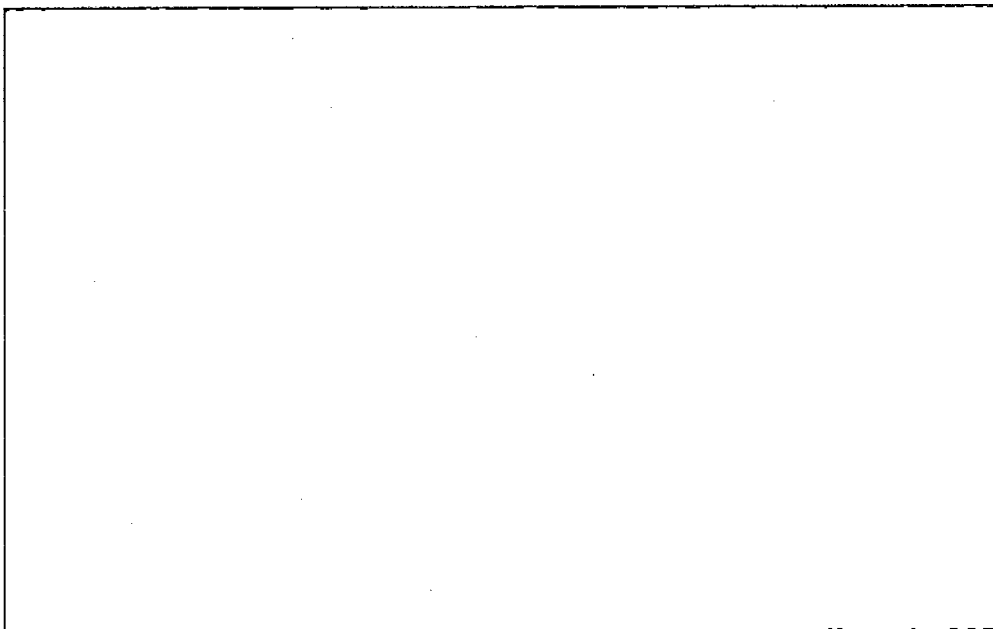

(*Id.* at 15 (found in PDP Spec, indicating that PDP is a service [])).

With respect to the [redacted] family of Arista's Redesigned Switches, the PDP Spec elaborates:

[redacted]

[redacted]

[redacted]

(*Id.* at 15-16 (emphases added)).

Figure 7: Architecture Used by Arista for [] Family of Redesigned Switches

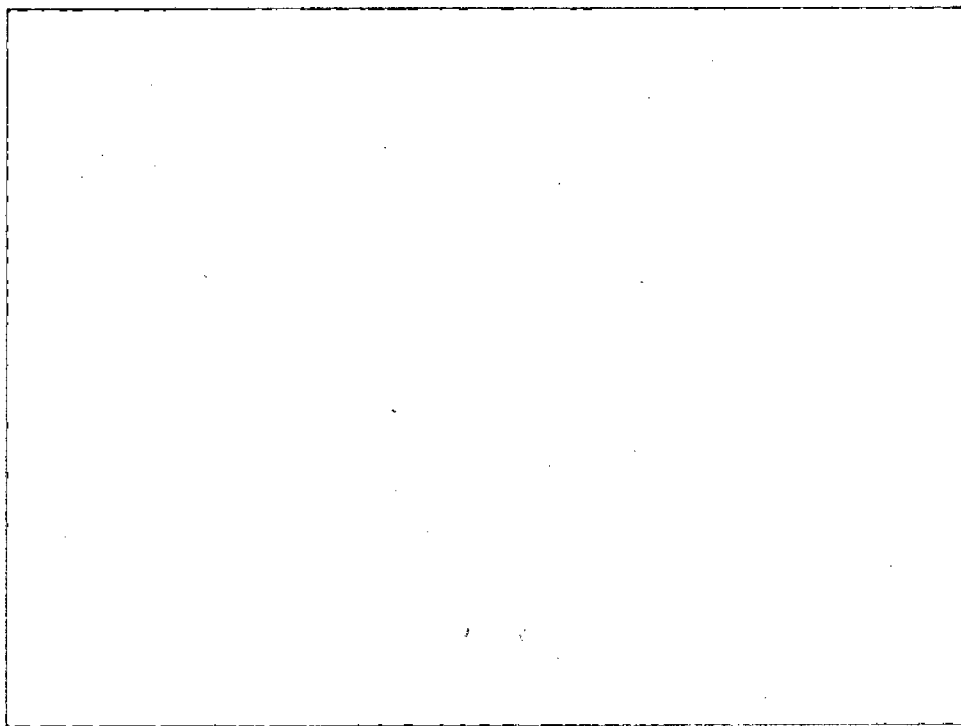

(*Id.* at 20 (found in PDP Spec, indicating that PDP is a service [])).

Figure 8: Architecture Used by Arista for [] Family of Redesigned Switches

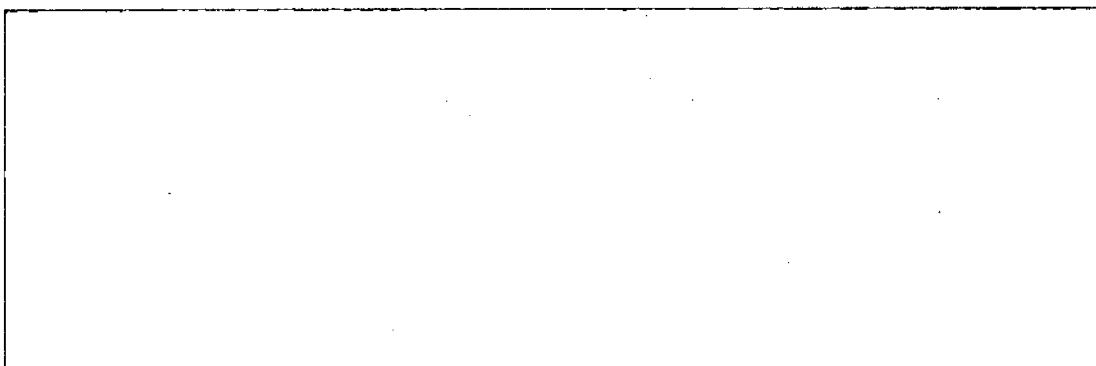

(*Id.* at 24 (found in PDP Spec, indicating that PDP is a service [])).

PUBLIC VERSION

What the PDP Spec lays bare, consistent with expert testimony, is that PDP is a service applied to [redacted]. (JX-9008C (PDP Spec) at 1, 8; Tr. (Almeroth) at 87:14-21, 153:1-3 ([redacted] and “[f]or [redacted], there is some overlap [with [redacted]]”); Tr. (Snoeren) at 230:3-231:5.). The PDP Spec also reveals that PDP is independent of other services applied to [redacted] in the sense that the former and latter are processed separately, albeit using different entries of the [redacted]. (JX-9008C (PDP Spec) at 17, 22; Tr. (Almeroth) at 89:17-90:6, 153:11-15.). The PDP Spec also clarifies that, in terms of marking packets for [redacted], the marking by PDP [redacted] marking by services such as [redacted]. (JX-9008C (PDP Spec) at 17 (“[W]e [redacted] applying the PDP policer over [redacted].”); *id.* at 22 (“If both PDP and [redacted] provide policer index values for a packet, the PDP result [redacted]”).

Additionally, PDP operates on [redacted] packets, not just packets [redacted]. (RX-9001C (Sweeney Witness Statement) at Q/A 34.). The Parties’ experts agree that packet [redacted] decisions are made [redacted] in the pipeline, after PDP has performed its counting or policing tasks and yet before [redacted] packets. (Tr. (Almeroth) at 85:14-22 (“If you look at where PDP is actually [redacted] packets, where it’s enforcing the policies and the policing, it happens [redacted]. So that’s where you’re applying [redacted]”); Tr. (Snoeren) at 272:9-12 (“Q: For example, in the [redacted] implementation of PDP, the [redacted] stage will determine that marked packets [redacted]”); JX-9008C (PDP Spec) at 16 (“If the PDP policer indicates the packet should be [redacted], then the packet is [redacted] [redacted]”). It is also clear that PDP policing *causes*

Redesigned Switches to [REDACTED]. (Tr. (Snoeren) at 271:25-272:8 (“Q: PDP policing causes [REDACTED]? A: Yes.”)).

2. PEAC Functionality

PEAC, the second of Arista’s functionalities accused of infringing the ’668 patent, stands for “Process Enforced Access Control.” (JX-9009C (PEAC Spec) at 1.). Unlike PDP, which is a [REDACTED] service, PEAC is a “feature [REDACTED] allows the switch administrator to [REDACTED] [REDACTED] whereby [REDACTED] is enhanced to check [REDACTED] [REDACTED] (*Id.*). “The Service ACL contains permit and deny rules matching any of the [REDACTED] [REDACTED] (*Id.*). “After receiving a [REDACTED] process evaluates [REDACTED] against the rules of the Service ACL configured for [REDACTED] and if the [REDACTED] matches a deny rule it is [REDACTED] (*Id.*).

Figure 9: Cisco's Depiction of PEAC

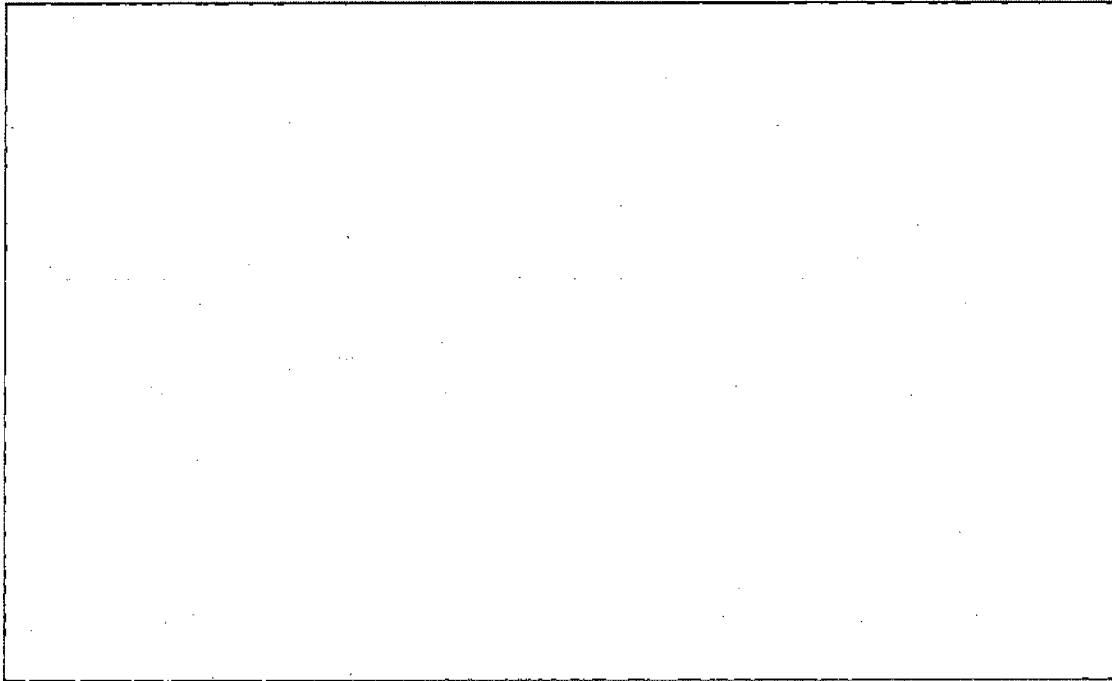

(CDX-9004C-26 (presented by Dr. Almeroth during the 2018 Hearing).

The Parties, and their witnesses, Dr. Almeroth and Dr. Sweeney, agree that Arista's EOS (Redesigned and Hardened Redesigned versions) contains specific, defined [redacted] [redacted]. (RX 9001C (Sweeney Witness Statement) at Q/A 158 159, 172; JX9009C (PEAC Spec) at 4; RX 9082 at 4 ("...[redacted]..."); CPBr. at 3; Tr. (Almeroth) at 69:13 70:7 (2018 Hearing) ([redacted] feature found [redacted] in the Underlying Investigation was [redacted])). Each [redacted] uses PEAC to call [redacted] to implement a [redacted]. (Tr. (Almeroth) at 101:7 15.).

"[redacted] is static code sitting in storage" (RX 9001C (Sweeney Witness Statement) at Q/A 210.). More specifically, [redacted] is "not a process," but [redacted]

[redacted]. (*Id.*). Instead of [redacted]
[redacted]. (Tr.
(Almeroth) at 166:1-22 (2018 Hearing); RX-9001C (Sweeney Witness Statement) at Q/A 210.).
When the [redacted] code is needed, it is [redacted]
by the [redacted]. (RX-9001C (Sweeney Witness
Statement) at Q/A 210.). As such, [redacted] is not a physical path of any kind. (*Id.*). It is
merely [redacted]—through which nothing travels that may be used within
[redacted]. (Tr. (Snoeren) at 249:24-250:13 (2018 Hearing).).

Arista acknowledges that the “function of [redacted] in PEAC is to provide [redacted]
[redacted] for packets that have [redacted]
[redacted] (RBr. at 31.). Yet, Arista simultaneously makes the
curious assertion that PEAC [redacted] [redacted]. (RX-9001C (Sweeney Witness
Statement) at Q/A 158, 174, 181; Tr. (Snoeren) at 243:2-12.).

Arista’s fact witness, Mr. Sweeney, explained that, within PEAC, “[y]ou’ve already
[redacted]
packet has arrived.” (RX-9001C (Sweeney Witness Statement) at Q/A 158, 181.).

Yet, testimony from Cisco’s expert, Dr. Almeroth, suggests that this statement
misrepresents PEAC, elevating form (where PEAC [redacted]) over function
(whether PEAC [redacted]). (Tr. (Almeroth) at 70:2-7
(PEAC “still [redacted] [redacted]” from “being
[redacted]”), 100:25-101:15 (PEAC

functions to [REDACTED]

[REDACTED]”) (2018 Hearing).).

Figure 10: Arista’s Side-by-Side Comparison of Infringing [REDACTED] (left) and “Redesigned” PEAC (right)

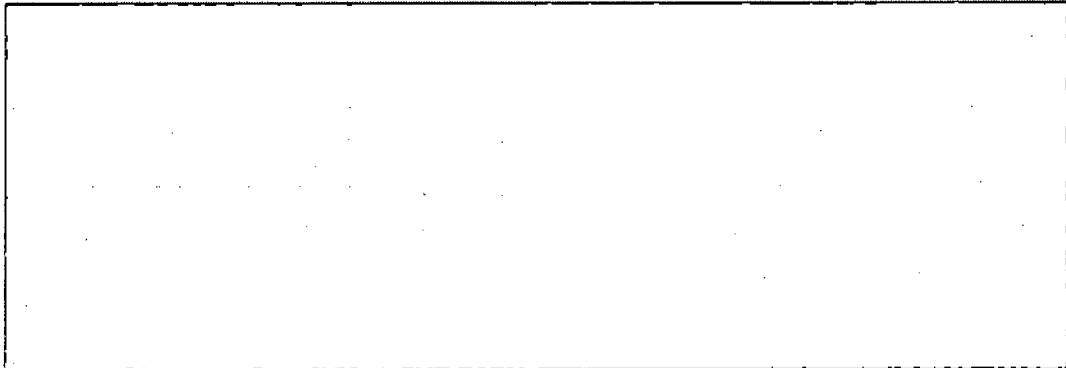

(RDX-9002C-5 (presented by Dr. Snoeren during the 2018 Hearing, consistent with Dr. Almeroth’s assertion (Tr. (Almeroth) at 69:13-70:7 (2018 Hearing)) that the [REDACTED] feature found to infringe in the Underlying Investigation was [REDACTED] [REDACTED]).).

B. Infringement Overview

Cisco asserts that the Redesigned Switches are covered by claims 1, 2, 4, 5, 7, 8, 10, 13, 18, 55, 56, and 64 of the ’668 patent. (See CBr. at Attach. B.). As discussed in more detail below, on a claim-by-claim basis, Cisco has proven this assertion by a preponderance of evidence.

1. PDP Literally Infringes Under the Plain and Ordinary Meaning of “Independent of,” But, in the Alternative, Under Arista’s Construction of that Term, Does Not Infringe Under the DOE.

Arista raises two main non-infringement arguments with respect to PDP, which share a common thread. (RBr. at 11-24.). That thread is that, because PDP was designed to [REDACTED] [REDACTED] solutions, it operates too close to the [REDACTED] of Arista’s Redesigned Switches; or too

[REDACTED] to qualify as control plane port services. (*Id.* at 11-12, 19). Each of Arista’s arguments references a diagram that Dr. Snoeren, one of Arista’s technical experts, drew when he testified during the 2018 Hearing, displayed below as Figure 11.

Figure 11: Diagram Drawn by Dr. Snoeren During the 2018 Hearing

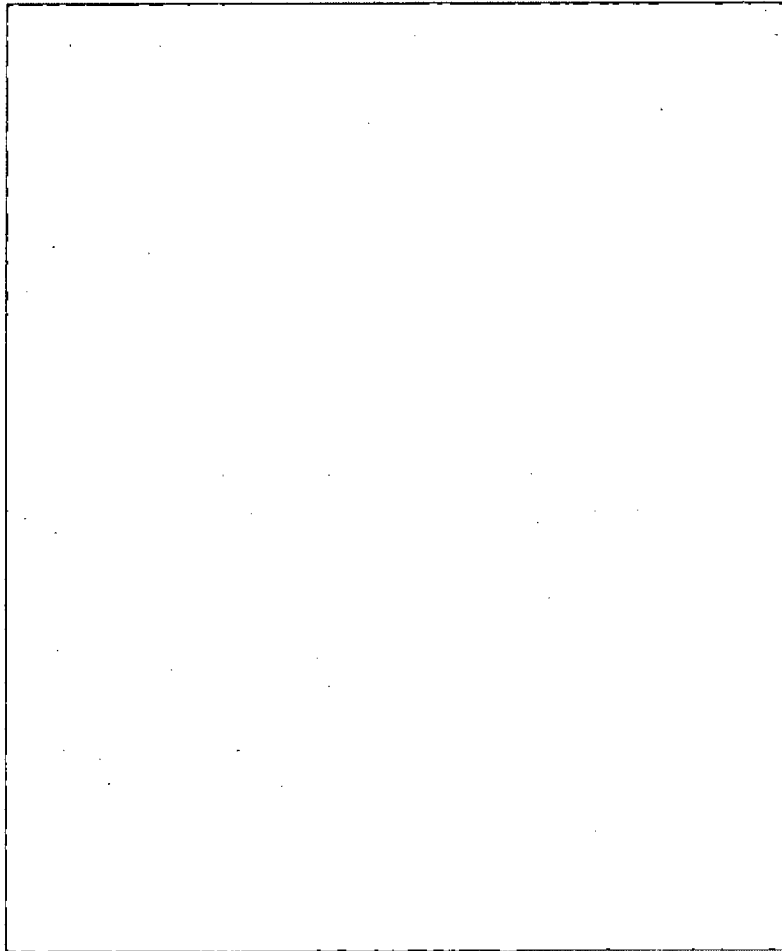

(RDX-9003C (diagram drawn by Dr. Snoeren during the 2018 Hearing)).

a) Arista’s Argument that PDP Is Not a “Control Plane Port Service” Is Flawed

Arista’s first argument is that PDP is not a “control plane port service,” as required by claims 1 and 55 of the ’668 patent. (RBr. at 11.). Arista argues that “PDP cannot satisfy this

claim limitation because it [redacted] (by [redacted] and either policing or counting) [redacted] [redacted] (*Id.*).

In other words, PDP “operates on packets [redacted].” (*Id.* at 12 (citing RX-9001C (Sweeney Witness Statement) at Q/A 34).).

Yet, the assertion that PDP is [redacted] is misleading. PDP accords [redacted] across [redacted]; it [redacted] some while [redacted] others. (Tr. (Almeroth) at 65:23-66:7 (2018 Hearing); JX-9008C.). Where [redacted] are indicative of one another, PDP is [redacted], including which packets [redacted]. (Tr. (Almeroth) at 62:24-63:13, 71:7-72:12, 137:21-24.)

During the 2018 Hearing, Dr. Almeroth identified 28 PDP classes that contain [redacted] [redacted]. (Tr. (Almeroth) at 71:12-72:5; 72:13 76:17; JX-9008C at 2-4; CDX-9004C-30 (Cisco’s depiction of PDP classes by Dr. Almeroth during 2018 Hearing).). Importantly, to mimic real-world conditions in his testing of Redesigned Switches, Dr. Almeroth used default settings. (Tr. (Almeroth) at 75:24-76:10, 77:16-21.).

Arista has not fully rebutted Cisco’s evidence that 28 PDP classes contain [redacted] [redacted]. In his 2018 Hearing testimony, Arista’s expert, Dr. Snoeren, failed directly to address 20 of those PDP classes. (*Id.*; RDX-9001C-6-7). As shown below in Figure 12, before or during the 2018 Hearing, Arista failed to offer any direct rebuttal evidence²⁸

²⁸ For several PDP classes that Dr. Almeroth identified as [redacted], instead

PUBLIC VERSION

(whether testimony or documents) with respect to 10 of the PDP classes that Dr. Almeroth identified as [REDACTED], under default conditions. (RBr. at App, B; Arista's Response to Order No. 17 at 1-17 (Doc. ID No. 637896 (Mar. 5, 2018) (chart)).

Arista has offered evidence that only five (5) of the classes identified by Dr. Almeroth are not used in the Redesigned Switches. (RX-9128C at 4-6; RX-9196C at 4-6; JX-9016C (PDP Spec, version 1.0.1) at 339-42.). While conceding the oversight, Cisco contends that Arista's evidence is "directly contradicted by Arista's own PDP Specification (an internal technical specification authored by Arista to describe PDP's operation)." (CRBr. at 7 (citing PDP Spec)). Additionally, Arista's decision to produce only [REDACTED]-platform switches for inspection limited Dr. Almeroth's testing opportunities and, according to Cisco, left the PDP Spec as the best evidence produced by Arista for operation of those platforms. (*Id.* at 8.).

Arista has offered dispositive evidence that Dr. Almeroth wrongly identified five (5) of the 28 classes as [REDACTED]. There is no reason why Dr. Almeroth's impeachment on these five (5) classes should undermine his testimony with respect to the remaining 23 classes, including 10 of which where his opinions stand unopposed. In other

of offering direct rebuttal evidence, Arista relies on Dr. Snoeren's sweeping testimony that fails to rebut Cisco's evidence with respect to the [REDACTED] of specific PDP classes. (Tr. (Snoeren) at 211:9-18 ("my tests very clearly show is that for each and every one of the classes that Dr. Almeroth earlier this morning alleged [REDACTED] PDP, in fact, [REDACTED] [REDACTED], 211:23-212:1 ("[W]hat I did is I took every class that Dr. Almeroth disclosed in his report, and I conducted a test that showed that [REDACTED]), 212:11-18 ("[A]gain I took all of the classes that Dr. Almeroth looked at in his report and conducted a test. And again, it showed that in each case [REDACTED].") (2018 Hearing)). In fact, as shown in Figure 12, Dr. Snoeren tested only 10 of the 28 PDP classes identified by Dr. Almeroth.

PUBLIC VERSION

words, contrary to the Malawian proverb, one muddy buffalo (or, here, five buffaloes) does not make the whole herd dirty.

Figure 12: Chart Showing “_____” PDP Classes Identified by Dr. Almeroth and Arista’s Direct Rebuttal Evidence for Each Such Class (with PDP Classes Lacking Direct Rebuttal Evidence Identified in Bold)

#	PDP Class	Tested by Dr. Snoeren? Y/N	Arista’s Purported Direct Rebuttal Evidence	Direct Rebuttal Evidence (Y/N)
1				Y
2				Y
3				N
4				N
5				Y
6				N
7				N

PUBLIC VERSION

8		Y
9		Y
10		N
11		Y
12		Y
13		N
14		N
15		Y
16		Y
17		Y

PUBLIC VERSION

18		Y
19		Y
20		Y
21		N
22		N
23		N
24		Y
25		Y

26		Y
27		Y
28		Y

(RBr. at App, B; Arista’s Response to Order No. 17 at 1-17 (Doc. ID No. 637896 (Mar. 5, 2018) (chart)).

In light of the above, Arista’s assertion that “no PDP classes contain only packets that are [redacted] is clever wordsmithing. (RBr. at 16 (citing Snoeren 211:19-212:1, 212:2-18, 215:20-216:2 (“[T]here are no red boxes up there [on CDX9004C-30] that he’s shown contain [redacted].”) (emphasis added)). Equally misleading is Arista’s contention that “[a]s testing confirmed, the other PDP classes Dr. Almeroth identified contain [redacted].” (*Id.* (citing Snoeren 211:19-212:1, 212:2-18, 215:20-216:2)).

Dr. Snoeren has demonstrated that Arista’s Redesigned Switches can be customized such that many, if not all, PDP classes can be [redacted] [redacted] and *vice versa*. (Tr. (Snoeren) at 267:1-20-268:17; RDX-9001C). Yet, the fact that PDP is [redacted], such that customers or experts can [redacted] [redacted] of Arista’s Redesigned Switches, ensuring that [redacted]

[redacted] does not change the infringement analysis.²⁹ See *Silicon Graphics, Inc. v. ATI Techs., Inc.*, 607 F.3d 784, 794 (Fed. Cir. 2010) (“[A]n apparatus claim directed to a computer that is claimed in functional terms is nonetheless infringed so long as the product is designed ‘in such a way as to enable a user of that [product] to utilize the function ... without having to modify [the product].’”). As Dr. Almeroth demonstrated, the default behavior of Arista’s Redesigned Switches is to configure certain PDP classes to [redacted]. (Tr. (Almeroth) at 71:12-72:5; 72:13 76:17; JX-9008C at 2-4; CDX-9004C-30; Tr. (Snoeren) at 267:1-20-268:17 (“Q: In fact, you don’t dispute that in at least one of Dr. Almeroth’s tests, the packets in Dr. Almeroth’s testing [redacted]; right? A: That is absolutely correct.”)).

In short, Arista’s lack of rebuttal evidence and the default behavior of the Redesigned Switches belies Arista’s first argument that PDP does not infringe.

Arista next argues that [redacted] PDP functionality is not a “control plane port service,” as required by claims 1 and 55, because it does not provide services to a “control plane port entity.” (RBr. at 17-19.). In so doing, Arista misconstrues the “claimed invention” as *segregating* “packets to a control plane port [redacted] [redacted] so that services could be applied only to those packets and not also to transit packets.”

²⁹ A PDP configuration in which [redacted] would truly be [redacted] and would likely not infringe in the absence of intra-class means for distinguishing between [redacted] packets. In that case, Arista’s Redesigned Switches would resemble the prior art, such that, to prevent DoS attacks, all packets would undergo policing, and none would undergo only [redacted]. As shown by Dr. Almeroth, that is *not* the default behavior of [redacted] [redacted] (Tr. (Almeroth) at 71:12-72:5; 72:13, 75:24-76:17, 77:16-21.).

(RBr. at 17 (citing Snoeren 204:18 205:20 (“the ’668 patent invents this notion of what it calls a control plane port entity which I’m going to draw here in red. And the important thing to realize about it is that it’s located on this vertical pathway [redacted], the path the only packets destined to the control plane processes are actually going to proceed along”).).

In fact, the ’668 patent teaches a variety of embodiments, some of which explicitly do not include a control plane port entity receiving control plane port services after segregation of control plane packets by a “switching element.” These include aggregate control plane services **145** operating in conjunction with a central switch engine, all within a route processor **125**, and, optionally, the central switch engine **130** itself providing the aggregate control plane services **145**. (JX-9001 (’668 patent) at Fig. 1, 6:58 64.).

Moreover, pursuant to the doctrine of claim differentiation,³⁰ asserted claims 1 and 55 must cover embodiments that apply control plane port services to packets within a “switching element” because claims 9 and 61, which depend from claims 1 and 55, respectively, require that “a central switch engine performs the aggregate control plane port services.” (*Id.* at 9:66-67, 14:4 5.).

Similarly, pursuant to the doctrine of claim differentiation, claims 1 and 55 are broad enough to cover the application of control plane port services within or even before “a switching

³⁰ See *RF Delaware, Inc. v. Pac. Keystone Techs., Inc.*, 326 F.3d 1255, 1263 (Fed. Cir. 2003) (internal quotations omitted) (“Under the doctrine of claim differentiation, each claim in a patent is presumptively different in scope.”); *Winbond Elecs. Corp. v. Int’l Trade Comm’n*, 4 F. App’x 832, 838-39 (Fed. Cir. 2001) (“[W]here some claims are broad and others are narrow, the narrow claim limitations cannot be read into the broad.”).

element” because dependent claims 4 and 58, which depend from claims 1 and 55, respectively, require that “the control plane port services are applied after a transit packet forwarding decision is made.” (*Id.* at 9:53-55, 13:46-48.). In other words, Arista’s interpretation of the ’668 patent’s claims correctly requires differential treatment of control plane packets, but Arista’s interpretation is overly narrow and restrictive in terms of where that treatment occurs.

Arista contends that PDP’s [REDACTED] distinguishes it from a control plane port service, and thereby absolves PDP’s policing [REDACTED] from infringement. (RBr. at 19.). Yet, [REDACTED] policing are separate features applied [REDACTED] [REDACTED] basis, and Cisco has accused only the latter of infringement. (CBr. at 11; JX-9008C (PDP Spec) at 1; Tr. (Almeroth) at 80:17-81:5; RX-9001C (Sweeney Witness Statement) at Q/A 37, 65.).). Indeed, the inclusion of non-infringing features within a device does not absolve the liability of directly infringing ones operating within the same device. *CIAS, Inc. v. Alliance Gaming Co.*, 504 F.3d 1356, 1361 (Fed. Cir. 2007) (when claims use “comprising,” the claim limitations do not “exclude the possible presence of additional elements or steps”).

Nothing in the asserted claims requires that accused functionality, PDP, include only infringing features. (JX-9001 (’668 patent) at 9:17-14:49.). Arista’s expert, Dr. Snoeren admitted as much at the Hearing. (Tr. (Snoeren) at 260:18-261:1 (“Q: And if those policer [REDACTED] that you’ve shown there infringe, the addition of [REDACTED] to PDP doesn’t take PDP out of infringement, right? A: Correct.”)).

b) Arista’s Argument that PDP Is Not “Independent of Physical Port Interfaces and Services Applied Thereto” Is Flawed

Arista’s second argument for non-infringement is that PDP does not operate on packets in

a way that is “independent of the physical port interfaces and services applied there to,” based on this statement by the Commission in its Opinion in the Underlying Investigation:

In essence, the problem is that, in prior art devices, all packets entering a port, whether data packets or control plane packets, were subjected to all of the services configured on that port. As a result, and consistent with the Final ID's finding, the limitation “*independent of means that “control plane port services,” which are applied to a “control plane port entity,”*” whether as a single aggregate port service or as distributed port services, “*are applied after the control plane packets exit the physical ports and services applied thereto.*” Final ID at 201.

(Commission Opinion (FD) at 98 (emphases added).).

Arista’s reliance upon the Commission’s statement with respect to “independent of” is an inappropriate attempt to narrow the construction of that term. (RBr. at 19-20.). It appears that Arista advanced this overly narrow construction “independent of” to make it difficult for Cisco to show infringement of the asserted claims of the ’668 patent. This is because PDP is not applied “*after the control plane packets exit the physical ports and services applied thereto.*” Dr. Almeroth testified that [redacted] features in the accused devices are physical port services: [redacted] [redacted] (Tr. (Almeroth) at 87:14-21, 152:20-25.).

As Arista demonstrated, and as Cisco did not dispute, at least [redacted] of these physical port services [redacted] —operate simultaneously with (and quite similarly to) PDP, in terms of using [redacted] [redacted].”³¹ (Tr. (Snoeren) at 206:4-14 (discussing RDX-

³¹ That said, PDP does not operate the same way as [redacted], in two important respects. First, PDP [redacted]. (JX-9008C (PDP Spec) at 17 (“[W]e [redacted]”); 22 (“If both

9003C), 212:19-213:22, 219:5-16, 219:22-220:4, 220:5-222:9 (discussing RDX-9001C-11, JX-9022 at 47), 222:21-223:1, 225:5-17, 226:17-227:7; RX-9001C (Sweeney Witness Statement) at Q/A 47, 48, 98-100 (Strata), 103-105 (Sand), 107-109 (Alta), 111 (XP80), 113-126.).

Arista's interpretation of the Commission's "independent of" statement requires additional explanation. The language quoted by the Commission "applied after the control plane packets exit the physical ports and services applied thereto" was recited verbatim from the ID in the Underlying Investigation. (ID at 201.). The ID quoted that language from the argument section of Cisco's post-hearing brief that addresses infringement of the '668 patent by the PiP CoPP feature in Arista's legacy switches. (CBr. (UI) at 25 (" [redacted] are [redacted] to the port services of the physical ports of the devices; they are applied only to packets [redacted] after [redacted] packets exit the physical ports and services applied thereto, such as Port ACLs; and the [redacted] [redacted]").).

Cisco never offered the quoted language as a claim term construction in this or in the Underlying Investigation. (*See, generally, Markman* Order.). The construction was not adopted in the ID. (*Id.*). The Commission quoted the language of the ID without any indication that Cisco and Arista disputed the construction, and without any signal that it was applying a new

PDP and [redacted] provide [redacted] for a packet, the PDP result [redacted] is not used"). Second, while [redacted], regardless of class, PDP assigns packets to classes and polices some of those classes, [redacted] [redacted], under default conditions. (*Id.* at 1-4; Tr. (Almeroth) at 71:12-72:5; 72:13 76:17, 80:17-81:5 (2018 Hearing); RX-9001C (Sweeney Witness Statement) at Q/A 37, 65; CDX-9004C-30 (Cisco's depiction of PDP classes by Dr. Almeroth during 2018 Hearing).).

PUBLIC VERSION

claim construction to replace the “plain and ordinary meaning” construction applied in the *Markman* Order and ID. (Commission Opinion (FD) at 98 (indeed, the Commission provided this language within a section addressing infringement and indicated that it was acting “consistent with the Final ID’s finding”).³²

If the Commission’s language is interpreted as applying a new or narrowed construction of “independent of,” then the Commission’s statement conflicts with the intrinsic evidence. The ’668 patent teaches the central switch engine **130** performing services applied to physical ports. (JX-9001 (’668 patent) at 7:1-11 (“switch engine **130** performs normal input port services and Quality of Service (QoS) processing on the received packet. In a next state **403**, the central switch engine **130** performs its normal Layer 2 and Layer 3 switching/routing decision.”). The ’668 patent also teaches the central switch engine **130** performing control plane port services. (*Id.* at Fig. 1, 6:58-64.). These disclosures, alone, do not conclusively resolve how physical port and control plane port services are ordered in terms of packet processing. The central switch engine could perform control plane port services *after* services applied to physical ports.

However, the ’668 patent goes on to teach the central switch engine **130** performing control plane port services *before or concurrent with* services applied to physical ports. As explained above in Section IV.B.1.a, pursuant to the doctrine of claim differentiation claims 1 and 55 are broad enough to cover the application of control plane port services before or

³² In the Underlying Investigation, it was held that “[t]here is nothing in the plain language of the asserted and unasserted claims to support the proposed language “without consideration of,” nor is there anything to suggest that “independent of must only mean “separate from.” (*Markman* Order at 61.). The Commission’s statement on “independent of” to mean “applied after the control plane packets exit the physical ports and services applied thereto” is in direct conflict with this rejection of a “separate from” limitation. (Commission Op. (FD) at 98.).

simultaneously with the making of “a transit packet forwarding decision,” such as a physical port service Layer 2 and Layer 3 switching/routing decision. (*Id.* at 9:53-55, 13:46-48 (dependent claims 4 and 58 require that “the control plane port services are applied after a transit packet forwarding decision is made.”)).

Therefore, the '668 patent discloses the application of control plane port services concurrent with or before, not separate from or after, physical port services. The Commission's Opinion contemplated this scenario, noting that “the patentees clearly envisioned allowing some level of per-port control, not merely requiring all control port traffic to be subject to a single control port policy.” (Commission Op. (FD) at 97.).

The Commission's reasoning indicates that it did not, as Arista contends, intend to narrow the invention to physical or temporal sequestration of physical port services and control plane port services. (*Id.* at 94-101.). The Commission explained that “the issue boils down to whether the invention of the '668 patent includes applying differing policing services on individual ports for packets destined to the control plane.” (*Id.* at 94.). The Commission recognized that “[i]n essence, the problem is that, in prior art devices, all packets entering a port, whether data packets or control plane packets, were subjected to all of the services configured on that port,” including services needed only to process control plane packets, in order to guard against DoS attacks. (*Id.* at 98.). The Commission continued, “the primary focus of the invention is, as Cisco notes, to prevent applying configurations to a physical port that will affect both control plane and transit packets.” (*Id.* at 101.).

The Commission's statement was made in a section entitled, “Direct Infringement.” (*Id.* at 87.). When the Commission reviewed a claim construction in other sections of its Opinion, it

PUBLIC VERSION

did so under the heading “Claim Construction.” (*Id.* at 11, 31.). The Commission’s statement on “independent of” was repeated, not from a *Markman* Order or a formal claim construction analysis, but from an argument section in Cisco’s Post-Hearing Brief, the concerned infringement of the ’668 patent by PiP CoPP, an Arista feature subsequently found to infringe.³³ (ID at 201 (“Cisco has met its burden of proof that per-input-port PiP CoPP services are ‘applied after the control plane packets exit the physical ports and services applied thereto,’ which satisfies [not defines] the ordinary meaning of ‘independent of.’”).

It can be inferred that the Commission signaled that “independent of” was satisfied by a service, even one applied to a physical port, that provided differential treatment of transit and control plane packets. Consequently, the Commission’s statement is not treated in this analysis as a distinct and new construction of the claim term “independent of,” that changes the ID’s construction or introduces new restrictions into the asserted claims. Instead, the Commission’s statement with respect to “independent of” is interpreted in this analysis as providing an operating condition sufficient, but not necessary, to infringe the ’668 patent.

That said, assuming *arguendo* that the Commission did intend to advance a new construction of the term “independent of,” the claim-by-claim infringement analysis that follows applies that construction, where appropriate, in the alternative.

³³ Claim construction of uncertain terms is properly based on an analysis of the intrinsic evidence, not an out-of-context argument by a party seeking to prove infringement. *Phillips*, 415 F.3d at 1321 (“In cases where the meaning of a disputed claim term in the context of the patent’s claims remains uncertain, the specification is the “single best guide to the meaning of a disputed term.”).

Cisco asserted in the alternative that, if the Commission's statement regarding "independent of" is a new construction, the Redesigned Switches with PDP functionality infringe under the doctrine of equivalents ("DOE").³⁴ This is not so, for reasons set forth in the claim-by-claim infringement analysis in Section IV.C.1.

2. PEAC Literally Infringes Under the Plain and Ordinary Meanings of "Control Plane Processes" and "Destined to" and the *Markman* Construction of "Control Plane Port Entity," and, in the Alternative, Under Arista's Constructions of These Terms, PEAC Infringes Under the DOE

Arista raises three (3) main non-infringement arguments with respect to PEAC. First, Arista argues that "destined to" means "not yet arrived at" and that PEAC [redacted] that have [redacted]. (Tr. (Snoeren) at 241:13-16, 243:22-23 (2018 Hearing); RPBr. at 39-41.). Second, Arista argues that PEAC "does not use a 'control plane port entity.'" (RBr. at 29 (citing ID at 182)). This is because PEAC is purportedly not "a single access path required for packets to access control plane processes" because PEAC operates as a [redacted]. (*Id.* (emphasis added)). According to Arista, [redacted] is located within [redacted] [redacted]. (*Id.*)

Finally, Arista asserts that PEAC does not infringe the '668 patent because, within

³⁴ "Infringement under the doctrine of equivalents may be found when the accused device contains an 'insubstantial' change from the claimed invention. Whether equivalency exists may be determined based on ... the 'triple identity' test, namely, whether the element of the accused device 'performs substantially the same function in substantially the same way to obtain the same result.'" *TIP Sys., LLC v. Phillips & Brooks/Gladwin, Inc.*, 529 F.3d 1364, 1376-77 (Fed. Cir. 2008) (citations omitted). The essential inquiry here is whether "the accused product or process contain elements identical or equivalent to each claimed element of the patented invention[.]" (*Id.*)

PEAC, there is a [REDACTED], such that a packet [REDACTED], whereas the claims mandate a one-packet-to-many-processes relationship. (RBr. at 30 (citing JX-9001 ('668 patent) at 9:16-41, 13:11-34; Tr. (Snoeren) at 249:14-18 (2018 Hearing); RX-9001C (Sweeney Witness Statement) at Q/A 210).). Each of Arista's arguments is addressed in turn.

Generally, Arista's non infringement arguments for PEAC apply unduly narrow (and new) constructions of asserted claim terms.³⁵ By unilaterally narrowing the asserted claims, Arista attempts to divert attention from the stated purpose of PEAC, which sounds exactly like the purpose of the invention disclosed in the '668 patent. (*Compare* JX 9020 at 1000 ("Service ACL enforcement is a feature added to a control plane service ... that allows the switch administrator to restrict the processing of packets and connections by the control plane processes.") *with* JX-9001 ('668 patent) at Abstract ("control plane port services thus can be utilized to control all packet traffic entering and exiting the control plane processes as a whole").).

a) Arista's Argument that Packets Controlled by PEAC Are Not "Destined to" Control Plane Processes Is Flawed

Arista's first non-infringement argument, a new construction of "destined to," misses the mark. All asserted claims of the '668 patent require "control plane port services operate on

³⁵ "A patent may not, like a 'nose of wax,' be twisted one way to avoid anticipation and another to find infringement." *Sterner Lighting, Inc. v. Allied Elec. Supply, Inc.*, 431 F.2d 539, 544 (5th Cir.1970) (citing *White v. Dunbar*, 119 U.S. 47, 51, 7 S.Ct. 72, 30 L.Ed. 303 (1886)).

packets ... *destined to the collection of control plane processes*” (JX-9001 ('668 patent) at 9:39-41, 13:30-33.). It is undisputed, functionally speaking, that PEAC [redacted] [redacted] between [redacted], thereby allowing a system administrator to restrict access to the latter. (JX-9009C (PEAC Spec) at 1; CX-9201C (Holbrook Dep.)³⁶ at 78:7-21 (“[T]he way [redacted] PEAC works, to my understanding, is the [redacted] ... to, in the part of the application where [redacted], to make a decision [redacted] [redacted].”).).

Thus, when packets arrive at a [redacted], and undergo PEAC processing, they are still destined to “control plane processes,” and the [redacted] [redacted], as the '668 patent describes. (JX-9001 ('668 patent) at 3:35-37 (“[b]ased upon information acquired through its control plane processes, packet forwarding behavior of the data plane elements is thus dictated”); Tr. (Almeroth) at 97:22-98:6 (“PEAC will do the [redacted] and that processing happens [redacted] [redacted].”).³⁷

³⁶ At the time of his deposition, on June 24, 2015, Dr. Hugh Holbrook (“Dr. Holbrook”) was Vice-President of Software Engineering at Arista. (ID at 84 n.63.). Mr. Holbrook was designated by Cisco as a fact witness on the structure, design, operation, and functionality of Arista’s products and features. (CPSt. at 2.).

³⁷ It is undisputed that the CP-ACL feature found to infringe in the Underlying Investigation was located [redacted]. (Tr. (Almeroth) at 95:22-96:12; CX-9186C at 43:21-44:1; CX-9190C at 117:22-118:15.).

Figure 13: Cisco's Depiction of PEAC's [] Role

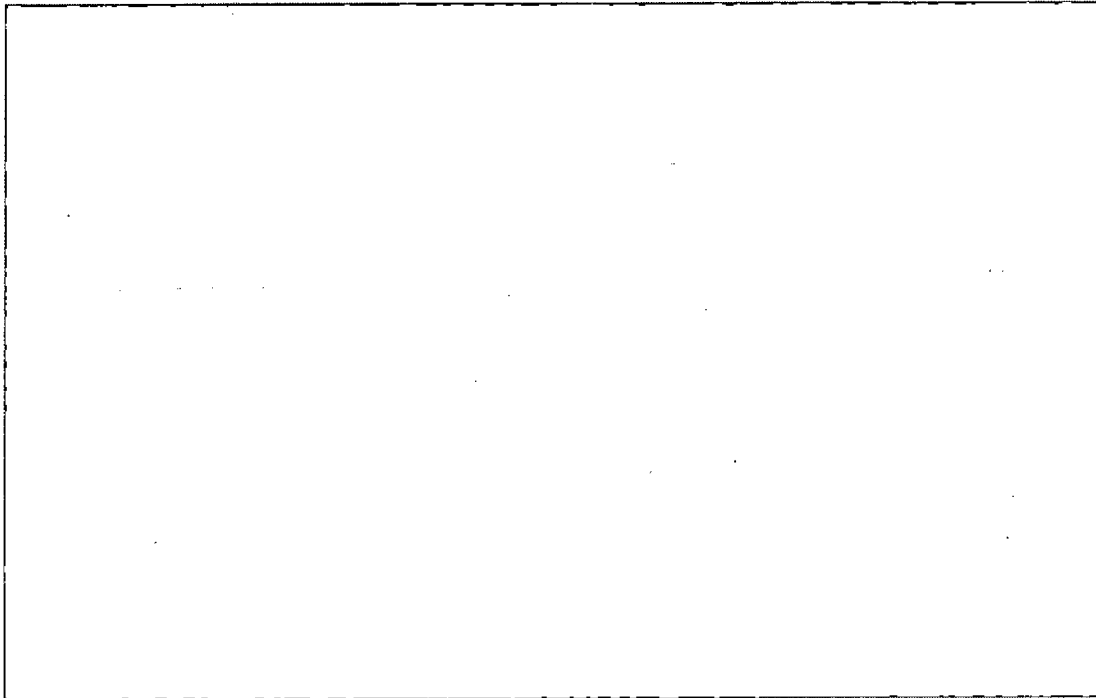

(CDX-9004C-70 (presented by Dr. Almeroth during the 2018 Hearing)).

b) Arista's Argument that PEAC Is Not a "Control Plane Port Entity" Is Flawed

Arista's second non-infringement argument—that PEAC is not a "control plane port entity" because it does not constitute "a single access path"—is similarly mistaken. The '668 patent treats "entity" as a collection of things. (JX-9001 ('668 patent) at Abstract ("Independent control plane processes may be provided; however, they are considered to be a single network *entity* that is a uniquely addressable port.") (emphasis added); 3:44-46 ("control plane processes are collectively arranged as a single addressable *entity*, to provide the ability to better manage control plane traffic") (emphasis added); 3:48-50 ("in embodiments of the invention, a collection of control plane processes are considered to be a single *entity* that is a uniquely addressable

PUBLIC VERSION

device port”) (emphasis added).

The Commission explained that “[n]either the claims nor the patent disclosure ... require that the ‘control port entity’ be a single object.” (Commission Op. (FD) at 95.). “The control plane port **140** may or may not be a single physical port.” (JX-9001 (’668 patent) at 5:1-2.). For example, the ID found that Pip CoPP infringed although it was applied at [REDACTED]. (ID at 196 (“[REDACTED] in the Redesigned Switches that have the CoPP feature enabled constitute the claimed ‘control plane port entity’”). The ’668 patent also teaches distributed control plane ports and port services implementing the invention, whereby there are multiple access paths to control plane processes. (JX-9001 (’668 patent) at 5:53-55 (“Regardless of whether the control plane port services are implemented as aggregate port services **145** or as distributed control plane services **146**, they perform certain basic functions.”)).

The foregoing explanation of “control plane port entity” was confirmed by both Arista’s and Cisco’s experts. According to Dr. Almeroth, “the ’668 patent at column 4, lines 65 through 54 talks about the control plane port entity. It doesn’t have to be a single physical port. It can be multiple entities. It’s defined as a single access path that can comprise multiple entities.” (Tr. (Almeroth) at 98:23-99:16 (2018 Hearing)). Dr. Snoeren agreed:

- Q:** But you know that the Commission has specifically held that a control plane port entity need not be a single object; right?
- A:** Correct. It has to be a single access path.
- Q:** Okay. But not a single object; right?
- A:** Correct.
- Q:** Could be made up of multiple objects?
- A:** Correct.

Tr. (Snoeren) at 263:5-15 (2018 Hearing).

Thus, according to the consistent expert testimony, Arista lacks evidentiary support for its argument that PEAC does not infringe because it operates as [REDACTED] [REDACTED]. As explained above, the '668 patent does not limit a "control plane port entity" to a single [REDACTED] of a feature or functionality. Thus, Arista's "single access path" argument fails.³⁸

c) Arista's Argument that PEAC Does Not Provide Access to a "Collection of Control Plane Processes" Is Flawed

Arista's last non-infringement argument for PEAC is that the Redesigned Switches do not infringe because each [REDACTED] within EOS is a [REDACTED] process and thus does not satisfy that claim limitation "a control plane port entity provides access to *the collection of control plane processes.*" (RBr. at 30.). As with "control plane port entity" above, Arista seeks to narrow the construction of "the collection of control plane processes" for non-infringement purposes. Arista's construction is unduly narrow and lacks evidentiary support.

The '668 patent discloses that "[t]he control plane 150 is typically not a single process or processor but rather a collection of processes."³⁹ (*Id.* at 5:21-23.). The asserted independent

³⁸ Additionally, the "control plane port entity" may be "a virtual address through which packets travel or are routed from the data plane 135 to the control plane 150," as "control plane 150 processes could be implemented as software at any level of a system, or as hardware." (JX-9001 ('668 patent) at 4:62-64.). In the Underlying Investigation, the infringing [REDACTED] feature, replaced by allegedly infringing PEAC, applied "an ACL to a control plane port entity implemented in [REDACTED]" (ID at 196-97.). PEAC is also [REDACTED]. (RDX9001C-16 ([REDACTED] depiction of a [REDACTED])).

³⁹ The '668 patent uses the reference number "155" to designate the control plane processes in the specification but uses the same reference number 155 to designate the control plane processor in Figure 1. (JX-9001 ('668 patent) at 5:64-65, Fig. 1.). Figure 1 depicts three boxes to show multiple control plane

claims of the '668 patent require only that control plane port services operate on packets destined to control plane processes. (Tr. (Almeroth) at 98:13-22 (2018 Hearing); JX-9001 ('668 patent) at 9:16-41 (“control plane port services operate on packets received from specific, predetermined physical ports and destined to the collection of control plane processes...”).). Dr. Almeroth’s explanation is consistent with thrust of the invention, which is the differential treatment of control plane packets and transit packets, as discussed in Section IV.B.1.b.

While the '668 patent states that “[i]n accordance with embodiments of the present invention, the control plane processes are implemented as independently executing processes,” there is no intrinsic or extrinsic evidence in the record to suggest that “independently executing processes” is a necessary element of the invention. (JX-9001 ('668 patent) at 3:42-44.). On at least one occasion, the '668 patent refers to control plane processes not as independently executing processes, but mere functions. (JX-9001 ('668 patent) at 5:36-40 (“An important aspect of the central switch engine 130 is that all packets destined to the control plane 150 must pass through the central switch engine 130 prior to being routed to the *functions 155 in the control plane 150.*”) (emphasis added).).

Against this backdrop, Arista equates process (singular) in the '668 patent with [REDACTED] [REDACTED] in the Redesigned Switches. In so doing, Arista contends that “in the PEAC architecture, there is a [REDACTED] [between “control plane port entities” and “control plane processes”] ... whereas the claims mandate a [REDACTED] relationship.” (Tr. (Snoeren) at

processors 155. (*Id.* Fig. 1.)” (ID at 184.).

PUBLIC VERSION

249:14-18; RX-9001C (Sweeney Witness Statement) at Q/A 210).).

Arista's argument is flawed for two reasons. As explained above, "[n]either the claims nor the patent disclosure ... require that the 'control [plane] port entity' be a single object," such as a [redacted] of PEAC. (Commission Op. (FD) at 95.). The term "control plane port entity" is broad enough to cover a [redacted], that [redacted] provide a "single access path" to [redacted] control plane processes. (Tr. (Almeroth) at 98:23-99:16 (2018 Hearing)).

Arista's non-infringement argument also fails in the event that "control plane port entity" cannot be a [redacted] of PEAC [redacted]. In that case, as Arista argues, each [redacted] of PEAC would be a separate "control plane port entity" providing access to an [redacted] [redacted]. (Tr. (Snoeren) at 249:14-18; RX-9001C (Sweeney Witness Statement) at Q/A 210).). While Arista asserts that each [redacted] of PEAC would provide access only to [redacted] [redacted], Arista's own User Guide for EOS version [redacted], dated November 16, 2017, suggests that each EOS [redacted] [redacted]. (JX-9020 at 1000 (PEAC "restrict[s] the processing of packets ... by the control plane processes that implement that service," where [redacted] [redacted]).

Indeed, Arista's User Guide comports with Cisco's view, in accordance with the teachings of the '668 patent, that "processes" "may be a sequence of steps that comprise the substantive processing and management functionality of the control plane." (CBr. at 28 (citing Tr. (Almeroth) at 94:15-95:1 (2018 Hearing); Tr. (Snoeren) at 276:16-21 (2018 Hearing) (conceding that the claimed control plane process need not be a "Linux process")). In other

words, for the “collection of control plane processes” limitation, Arista’s own documentation of PEAC agrees with the Cisco’s infringement argument, not Arista’s non-infringement argument.

In short, the asserted claims of the ’668 patent do not contain the limitations that Arista seeks to import into them for non-infringement purposes. The claim language of the ’668 patent requires only that control plane port services are applied to a control plane port entity, such that control plane port services operate on packets destined to control plane processes. (Tr. (Almeroth) at 98:13-22 (2018 Hearing); Tr. (Snoeren) at 278:8-279:4; JX-9001 (’668 patent) at 9:36-41 (“control plane port services operate on packets received from specific, predetermined physical ports and destined to the collection of control plane processes...”).).

PEAC acts as a single access path to control plane processes and provides control plane port services through calls to the [REDACTED]. (Tr. (Almeroth) at 98:23-99:16, 101:7-15; (RX-9001C (Sweeney Witness Statement) at Q/A 210). PEAC operates on packets destined to control plane processes, [REDACTED]
[REDACTED]
control plane processes.” (JX-9020 at 1000; JX-9001 (’668 patent) at 3:42-47, 4:65-57.).

The ’668 patent teaches an embodiment that resembles (without matching) PEAC’s use of ACLs to restrict access to control plane processes:

The specific control plane feature (i.e., rate limit with access list) can then be applied by the control plane services 145 or 146, thus preventing even correctly addressed packets from progressing up to any of the control plane processes 155 if the specific rate limit has been exceeded. ... Additional attributes of the port services may be defined as *access control lists*. ... Specifically, only these packets that match the *access control list (ACL)* are policed. The last ACL statement 512 includes a match for any packet equal to Telnet. The deny ACL statements allow those packet types to skip the policer and therefore would always be forwarded.

(JX-9001 ('668 patent) at 6:18-24, 7:46-61 (emphases added).).

Thus, as addressed in the claim-by-claim analysis below, Arista's PEAC functionality found in the Redesigned Switches satisfies the asserted claims of the '668 patent.

Cisco asserts in the alternative that, under Arista's constructions of "control plane port entity," "control plane processes," and "destined to", the Redesigned Switches with PEAC functionality also infringe under the DOE. This is so, for reasons set forth in the claim-by-claim infringement analysis in Section IV.C.1.

C. Claim-by-Claim Analysis

Cisco has alleged that the Redesigned Switches practice independent claims 1 and 55, and dependent claims 2, 4, 5, 7, 8, 10, 13, 18, 56 and 64 of '668 patent. "Determination of infringement is a two-step process which consists of determining the scope of the asserted claim (claim construction) and then comparing the accused product . . . to the claim as construed." *Certain Sucralose, Sweeteners Containing Sucralose, and Related Intermediate Compounds Thereof*, Inv. No. 337-TA-604, Comm'n Op. at 36 (U.S.I.T.C., April 28, 2009) (citing *Litton Sys., Inc. v. Honeywell, Inc.*, 140 F.3d 1449, 1454 (Fed. Cir. 1998)).

An accused device literally infringes a patent claim if it contains each limitation recited in the claim exactly. *Litton*, 140 F.3d at 1454. Each patent claim element or limitation is considered material and essential. *London v. Carson Pirie Scott & Co.*, 946 F.2d 1534, 1538 (Fed. Cir. 1991). In a Section 337 investigation, the complainant bears the burden of proving infringement of the asserted patent claims by a preponderance of the evidence. *Enercon GmbH v. Int'l Trade Comm'n*, 151 F.3d 1376, 1384 (Fed. Cir. 1998). If any claim limitation is absent,

there is no literal infringement of that claim as a matter of law. *Bayer AG v. Elan Pharm. Research Corp.*, 212 F.3d 1241, 1247 (Fed. Cir. 2000).

1. Independent Claims 1 and 55 of the '668 Patent Cover the Redesigned Switches

As shown below in Figure 14, with respect to claims 1 and 55, Arista does not dispute or offer evidence in rebuttal to Cisco's evidentiary showing that the Redesigned Switches satisfy the preamble and claim subsections a, b, and c. (RBr. at 11-23, 25-32; Tr. (Almeroth) at 207:1-8 (2018 Hearing) (claim 1 has "five separate [subsections], and the first three aren't disputed and they're just basically describing the fact that we have a switch here, the real inventive nature of the '668 patent comes down to those last two limitations ... they focus on the fact that you have to have this control plane port entity upon which the control plane port services are then going to be applied.")).

Instead, Arista and Cisco dispute the presence of only claim subsection d, which consists of two claim limitations: (i) "control plane port entity provides access to the collection of control plane processes, so that a set of control plane port services can be applied thereto"; and (ii) "control plane port services operate on packets received from specific, predetermined physical ports and destined to the collection of control plane processes in a way that is independent of the physical port interfaces and services applied thereto." (*Id.*).

Figure 14: Cisco's Depiction of Narrowed Infringement Dispute With Respect to Claim 1 of the '668 Patent

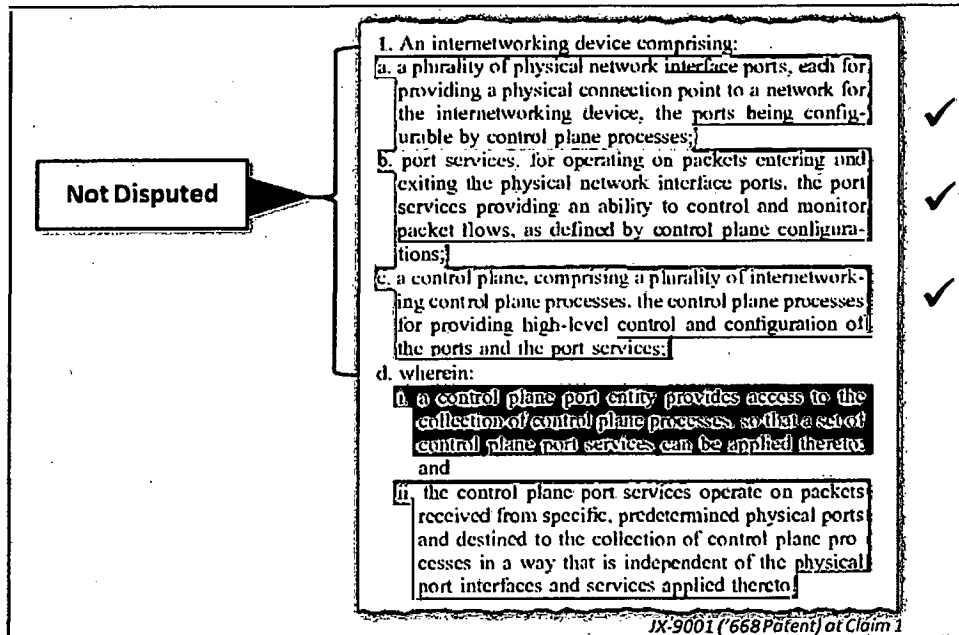

(CDX-9004C-55 (limitations from claim 1 in connection with PDP functionality of Redesigned Switches, presented by Dr. Almeroth during the 2018 Hearing) (see also CDX-9004C-75 (similar with respect to PEAC)).

- i. **Preamble:** “[A computer readable storage medium containing instructions readable by a computer to configure the computer to perform a method for processing packets in] An internetworking device comprising”

Cisco contended, and Arista did not dispute, that all of the Redesigned Switches meet the preamble of claims 1 and 55 of the '668 patent. (CBr. at 21; RBr. at 12-32; Tr. (Snoeren) at 207:1-8 (2018 Hearing)). Accordingly, because there is no dispute, Cisco has met its burden in proving by a preponderance of the evidence that the Redesigned Switches meet the preamble of claims 1 and 55 of the '668 patent.

- ii. **Subsection (a.):** “[configuring] a plurality of physical network interface ports, each for providing a physical connection point to a network for the internetworking device, the ports being configurable

by control plane processes”

Cisco claimed, and Arista did not dispute, that all of the Redesigned Switches meet this limitation. (CBr. at 21; RBr. at 12-32.). Dr. Almeroth testified, and Dr. Snoeren did not dispute, that based, *inter alia*, on an Arista EOS user manual (CX-9026),⁴⁰ all of the Redesigned Switches have a plurality of network interface ports. (Tr. (Almeroth) at 87:10-13 (2018 Hearing); Tr. (Snoeren) at 207:1-8 (2018 Hearing); CX-9026.). Moreover, Cisco provided evidence that the ports are configurable by control plane processes. (CX-9026 at 409, 415; JX-9020 at 495, 501.). Accordingly, because there is no dispute between Cisco and Arista, Cisco has met its burden in proving by a preponderance of the evidence that the Redesigned Switches meet limitation ii of claims 1 and 55 of the '668 patent.

iii. Subsection (b.): “[executing] port services, for operating on packets entering and exiting the physical network interface ports, the port services providing an ability to control and monitor packet flows, as defined by control plane configurations”

Cisco claimed, and Arista did not dispute, that all of the Redesigned Switches meet this limitation. (CBr. at 22; RBr. at 12-32.). Dr. Almeroth testified, and Dr. Snoeren does not dispute, that based, *inter alia*, on an Arista EOS user manual (CX-0221), all of the Redesigned Switches have port services, which include [REDACTED]

[REDACTED] (CBr. at 22 (citing Tr. (Almeroth) at 86:25-87:5, 87:14-21 (2018 Hearing); Tr. (Snoeren) at 207:1-4 (2018 Hearing); JX-9014C at 1; CX-

⁴⁰ This document, entitled “Arista Networks User Manual,” discusses Arista’s switches, their supported features, and switch feature availability on certain switch platforms. (CX-0221 at CSI-ANI-00128383.000044.).

9140C at 1-5; CX-9060C at 11.). In addition, Cisco has provided undisputed evidence that all of the port services are configurable by Arista's EOS software. (JX-9020 at 743, 1205; JX-9014C at 1; CX-9140C at 1-5). Accordingly, because there is no dispute between Cisco and Arista, Cisco has met its burden in proving by a preponderance of the evidence that the Redesigned Switches meet limitation iii of claims 1 and 55 of the '668 patent.

- iv. Subsection (c.): “[executing] a control plane, comprising a plurality of internetworking control plane processes, the control plane processes for providing high-level control and configuration of the ports and the port services”**

Cisco claimed, and Arista, through its expert, Dr. Snoeren, did not dispute, that all the Redesigned Switches meet this limitation. (CBr. at 22; RBr. at 12-32.). Cisco has provided evidence showing that Arista's Redesigned Switches possess a control plane in the form of . (Tr. (Almeroth) at 86:25-87:5, 87:22-88:3; Tr. (Snoeren) at 207:1-4; CX-9027 at 2). This control plane provides high-level control and configuration of ports and port services via Arista's EOS. (JX-9020 at 50.). Because there is no dispute between Cisco and Arista, Cisco has met its burden of proving by a preponderance of the evidence that the Redesigned Switches meet limitation iv of claims 1 and 55 of the '668 patent.

- v. Subsection (d.i.): “[accessing the collection of control plane processes as] a control plane port entity provides access to the collection of control plane processes, so that a set of control plane port services can be applied thereto”**
- a. PDP Satisfies This Limitation (d.i.) Under the Plain and Ordinary Meaning of “Control Plane Port Services”**

Cisco presented evidence that the Redesigned Switches with PDP functionality meet this limitation. (CBr. at 22-23.). Dr. Almeroth offered his opinion that PDP acts as a “control plane port entity” that provides access to “control plane processes” and that applies “control plane port services” in the form of control plane packet policers. (Tr. (Almeroth) at 88:11–22 (2018 Hearing) (referencing Figure 15 (below), provided by Dr. Snoeren to CBP).).

Figure 15: Arista’s Depiction of PDP Functionality

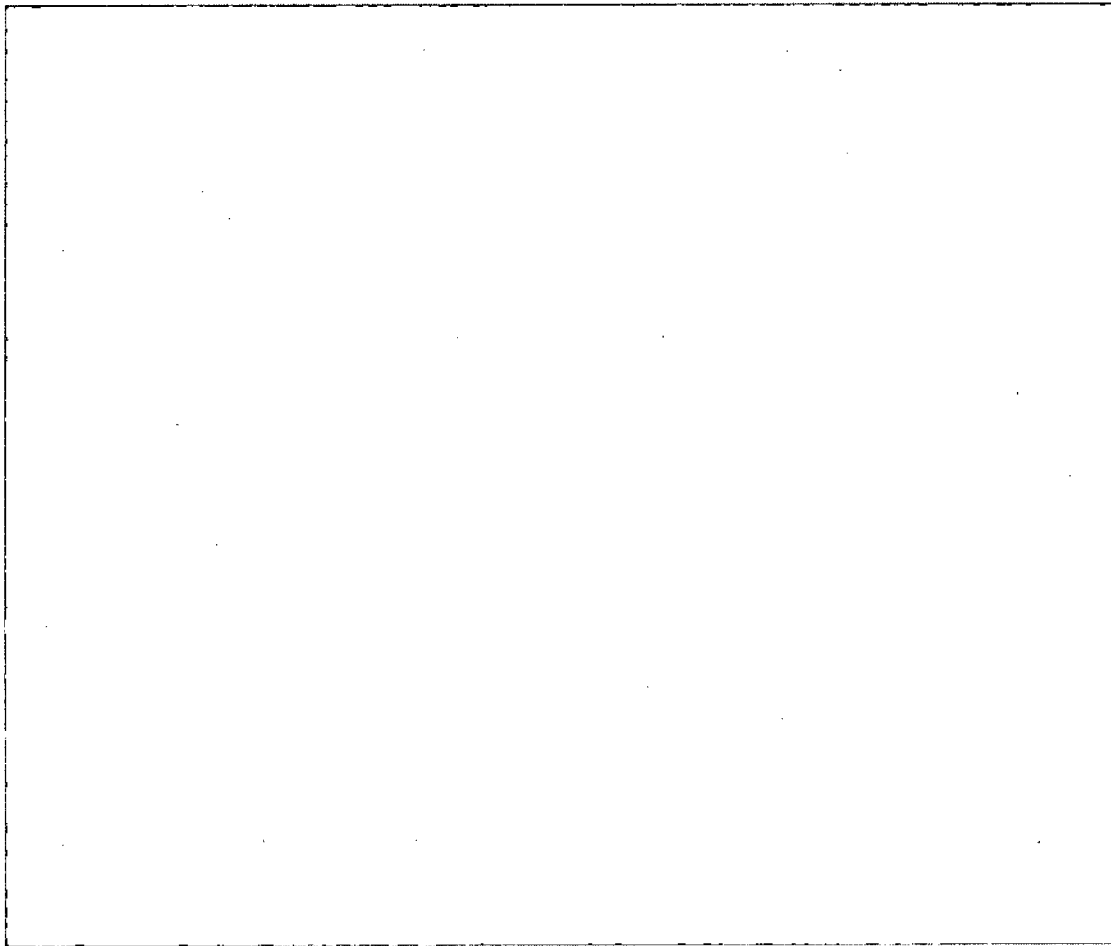

(CDX-9007C (presented by Arista to CBP on May 8, 2017 (ARISTA-945CBP-00000077))).

Dr. Almeroth identified 24 PDP classes comprised [redacted]

[redacted]. (JX-9008C (PDP Spec); JX-9020C (EOS

PUBLIC VERSION

user guide), CPX-9065C (source code), JX-9022C (switch spec); CX-9043C (switch spec); CX-9009C (switch spec); CX-9019C (switch spec); CX-9190C (deposition testimony of Hua Zhong,⁴¹ Arista software manager); CX-9186C (deposition testimony of Daniel Imfeld,⁴² CTO of Carevoyance); CX-9201C (deposition testimony of Hugh Holbrook); and CX-9213C (testing of [redacted]); CX-9214C (testing of [redacted]); CX-9215C (testing of [redacted]); CX-9216C (testing of [redacted]); CX-9217C (testing of [redacted]); CX-9218C (testing of [redacted]).).

Dr. Almeroth performed testing on some of the 24 PDP classes, using standards-compliant packet types and default settings in Arista's Redesigned Switches. (Tr. (Almeroth) at 75:24-76:10, 77:16-21 (2018 Hearing).). Dr. Almeroth's testing confirmed that, consistent with Arista's technical documentation, certain types of packets, including those in the following classes, are [redacted] [redacted]”): [redacted] (CX-9213C), [redacted] (CX-9214C), [redacted] (CX-9215C), [redacted] (CX-9216C), [redacted] (CX-9217C), [redacted] (CX-9217C), and [redacted] (CX-9218C). (*Id.* at 76:11-17.). (Tr. (Almeroth) at 71:22-72:5, 72:21-73:12, 73:18-24, 75:2-19 (2018 Hearing); Tr. (Snoeren) at 214:4-17 (2018 Hearing) (an [redacted]-class packet is a type of packet that “we all know was never going to be a [redacted]”), 263:23-264:8; JX-9015C at 1; CX-9190C at _____

⁴¹ At the time of his deposition, on July 17, 2015, Hua Zhong (“Mr. Zhong”) was a Software Manager at Arista. (CX-9190C at 9.). Mr. Zhong was designed by Cisco as a fact witness on the “[s]tructure, design, operation, and functionality of Arista’s products and features.” (CPSt. at 2.).

⁴² At the time of his deposition, on August 4, 2015, Daniel Imfeld (“Mr. Imfeld”) was the CTO of Carevoyance, a startup performing data analysis for healthcare. (CX-9186C at 10-11.). Mr. Imfeld had previously worked for five years at Arista, focusing on access control lists, among other things. (*Id.* at 13-16.). Mr. Imfeld was designed by Cisco as a fact witness on “[s]tructure, design, operation, and functionality of Arista’s products and features.” (CPSt. at 2.).

78:12-17; CPX-9065C; JX-9008C at 3; CX-9006C at 7-8; CPX-9065; CDX-9004C-35A-36; JX-9020 at 2597, 1356; CX-9192C at 69:13-16; CX-9003C at 1.). These [redacted] packets receive [redacted] services in the form of PDP policing. (Tr. (Almeroth) at 160:4-161:2 (2018 Hearing)).

Figure 16: Cisco's Depiction of PDP Classes Comprised by Default Exclusively of Packets [redacted]

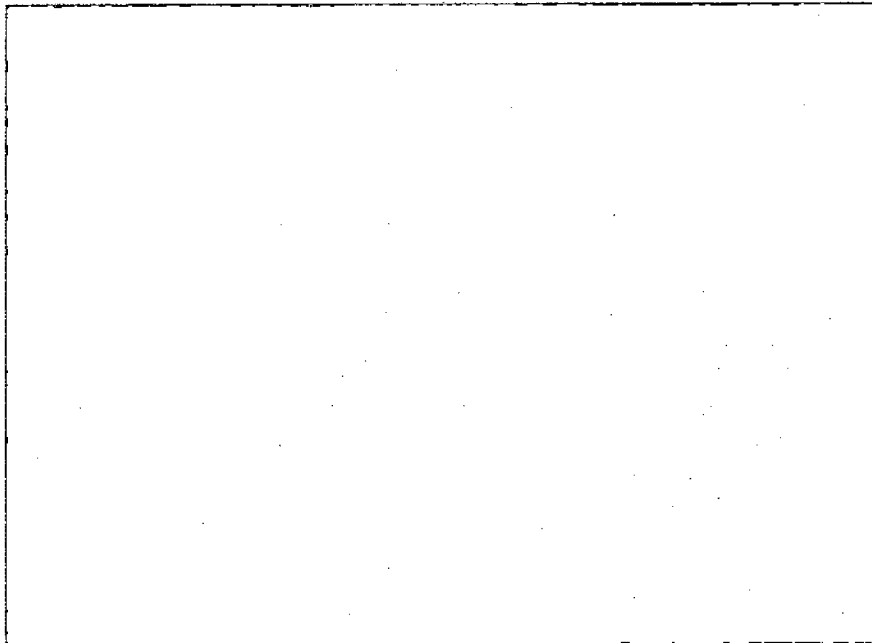

(CDX-9004C-30 (presented by Dr. Almeroth during the 2018 Hearing)).

Figure 17: Cisco's Depiction of PDP Classes Comprised by Default Exclusively of Packets
[REDACTED], as Confirmed by Testing

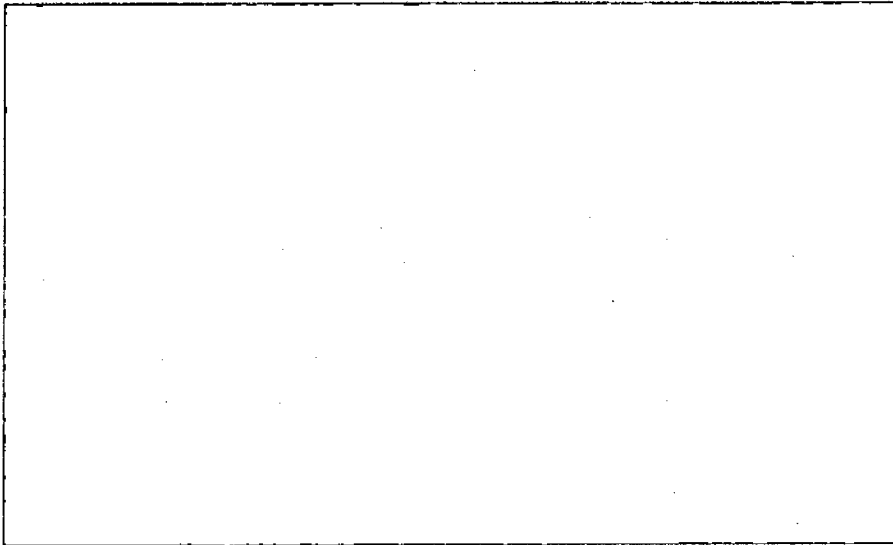

(*Id.* at 37 (presented by Dr. Almeroth during the 2018 Hearing)).

As addressed in the Infringement Overview, Section IV.B.1.a *supra*, Arista's rebuttal evidence on the operation of PDP classes fails to provide rebuttal evidence for 10 PDP classes identified by Dr. Almeroth and, where rebuttal evidence is provided, fails to adequately distinguish between default and custom configurations.⁴³ See *Ericsson, Inc. v. D-Link Sys., Inc.*, 773 F.3d 1201, 1215-17 (Fed. Cir. 2014) (“[W]hen the asserted claims recite capability, our case law supports finding infringement by a ‘reasonably capable’ accused device ... particularly

⁴³ Arista attempted to supplement its evidentiary showing by including a Declaration of Dr. Snoeren Order No. 16, Question 2(c), as Appendix E to its Post-Hearing Brief. (RBr., App. E). Cisco moved to strike this Declaration, as untimely evidence and expert testimony. (Mot. Docket No. 945-064 (Feb. 12, 2018)). That motion was granted-in-part on March 16, 2018, striking Appendix E and citations thereto, including Dr. Snoeren's newly disclosed opinions pertaining to the operation of PDP classes.

PUBLIC VERSION

where ... there is evidence that the accused device is actually used in a non-infringing manner and can be so used without significant alterations.”); *Finjan, Inc. v. Secure Computing Corp.*, 626 F.3d 1197, 1204 (Fed. Cir. 2010) (holding ““an accused device may be found to infringe if it is reasonably capable of satisfying the claim limitations, even though it may also be capable of non-infringing modes of operation.’”).

During the Hearing, Dr. Snoeren presented rebuttal test results for only eight (8) of the twenty-eight (28) packet classes that Dr. Almeroth identified as allegedly containing only [redacted] [redacted] under default conditions in Redesigned Switches. (RDX-9001C at 6-7 (addressing [redacted] [redacted])). However, with respect to the classes for which Dr. Snoeren provided rebuttal test results, he intentionally configured Redesigned Switches to override default PDP behavior.

Q: And there were configuration differences between your tests and Dr. Almeroth’s; right?

A: Yes.

Q: And in your tests, you showed different configurations that caused the very same packets to go to [redacted]; right?

A: Yes, that’s exactly what I was trying to show.

(Tr. (Snoeren) at 267:13-20.).

Dr. Snoeren’s testing enabled [redacted] [redacted] and is a default setting on Redesigned Switches. (Tr. (Almeroth) at 78:2-15, 82:15-19 (2018 Hearing); Tr. (Snoeren) at 267:13-17 (2018 Hearing); JX-9020 at 933; RX-9184C; RX-9240; RX-9228C; RX-9216C; RX-9188C). Dr. Snoeren also disabled an [redacted] default setting for his testing of the [redacted] class. (RX-9172C; RX-9180C.). Disabling this

feature prevents [] packets [] from [].
(Tr. (Almeroth) at 78:16-20, 82:15-19 (2018 Hearing); JX-9020 at 2125.).

Similarly, Dr. Snoeren conducted testing after disabling [] thereby preventing [] packets [] from []. (Tr. (Almeroth) at 78:16-20, 82:15-19 (2018 Hearing); JX-9020 at 1126; RX-9196C.). Finally, Arista configured its switch ports on the same [],⁴⁴ ensuring that packets normally [] would be prevented from doing so. (RX-9196C; RX-9204C; RX-9212C; RX-9224C; Tr. (Almeroth) at 78:16-20, 82:15-19 (2018 Hearing); JX-9020 at 901.). In other words, Dr. Snoeren's testing appeared to "rig" the settings to in effect show that the Redesigned Switches do not infringe.

In sum, Arista fell far short in terms of rebutting Cisco's evidence that PDP uses [] [] to operate as "control plane port entity" that provides access to "control plane processes." Arista failed to offer compelling rebuttal evidence that each of the PDP classes that Dr. Almeroth identified failed to [] *under default settings*. See *Lucent Techs.*, 580 F.3d at 1317 ("[A] finding of infringement can rest on as little as one instance of the claimed method being performed during the pertinent time period.").

Accordingly, based on the weight of the evidence, Cisco has met its burden of proving by a preponderance of the evidence that the Redesigned Switches contain PDP functionality that meets this limitation. PDP acts as a "control plane port entity" that, under default conditions,

⁴⁴ VLAN is a type of physical port service. (CPBr. at 30.).

uses [] to provide access to “control plane processes” and that applies “control plane port services” in the form of [] [].

b. PEAC Satisfies This Limitation (d.i.) Under the Plain and Ordinary Meaning of “Control Plane Processes” and the *Markman* Construction of “Control Plane Port Entity”

Cisco presented evidence that the Redesigned Switches with PEAC functionality satisfy this limitation. (CBr. at 22-23.).

Dr. Almeroth offered his opinion that PEAC acts as a “control plane port entity” that provides access to “control plane processes” and to which “control plane port services” are applied in the form of []. (Tr. (Almeroth) at 100:1-10.). Cisco contends that [] functionality embedded by PEAC (and triggered with a call to []) is a “control plane port entity” because it provides “a single access path required for packets to access control plane processes,” as provided by [] in Redesigned Switches. (CX-9201 at 69:14-18, 74:5-11, 76:5-77:5; JX-9009C at 4-5.).

Figure 18: Cisco's Depiction of Control Plane Processes [REDACTED]

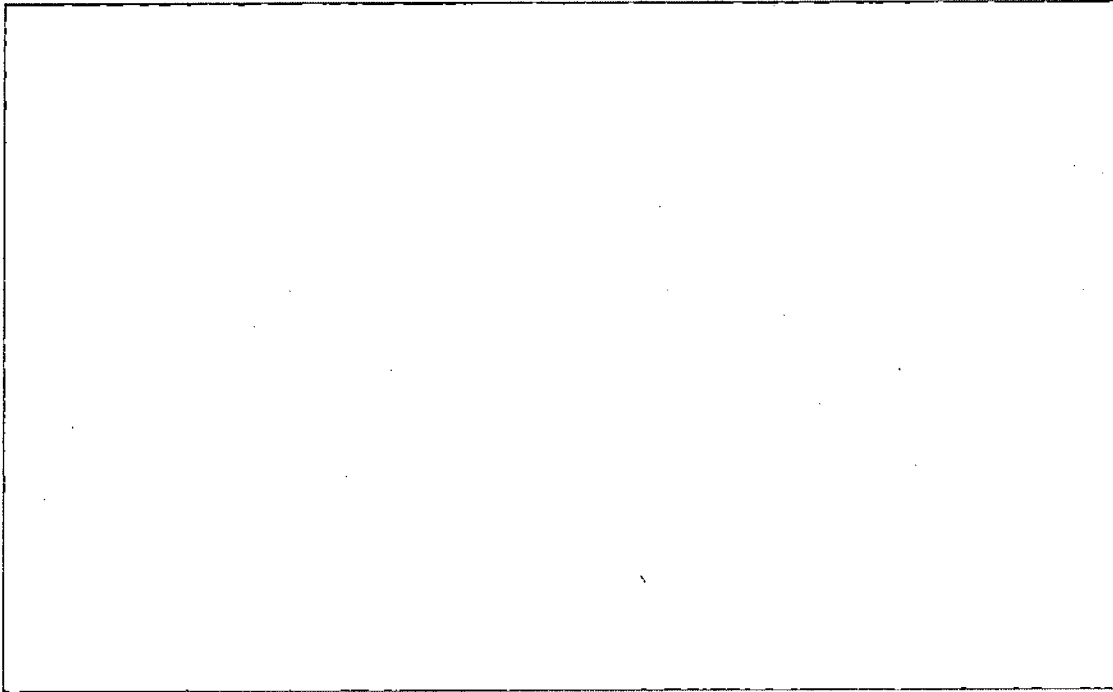

(CDX-9004C-77 (presented by Dr. Almeroth during the 2018 Hearing)).

In rebuttal, Arista offered two arguments. First, PEAC does not qualify as a “control plane port entity” because PEAC is not “a single access path.” (RBr. at 25 (citing Snoeren 246:13-247:21; 248:16-249:18; 276:22-279:4), 29.). Rather, Arista contended it is [REDACTED]. (Id.).

Second, Arista argues that PEAC does not infringe because the PEAC [REDACTED] provides access to [REDACTED], not the “collection of control plane processes” required by the asserted claims. (RBr. at 30.).

It is apparent from these arguments that, with respect to alleged infringement by PEAC, the relevant disputes between Arista and Cisco concern not how PEAC functionality operates,

but rather the proper application of asserted claim terms. Each of Arista's attempts to narrow claim construction is addressed below.

As for its first non-infringement argument, Arista failed to provide compelling evidence that PEAC does not constitute a "control plane port entity." Dr. Snoeren testified that PEAC lacks a "control plane port entity" because PEAC applies [redacted] to packets that have already [redacted]. (Tr. (Snoeren) at 246:16-247:5 (2018 Hearing)). Arista also presented evidence that the [redacted] purportedly identified by Cisco as PEAC's "control plane port entity," is a [redacted] used on an as needed basis by the [redacted] and nothing more than [redacted]." (RX-9001C (Sweeney Witness Statement) at Q/A 210); Tr. (Almeroth) at 166:1-22 (2018 Hearing)).

However, Arista failed to offer evidence that the control plane port entity claimed by the '668 patent precludes an embodiment where the access path is comprised of [redacted]. According to the '668 patent, the "control plane port entity" may be "a virtual address through which packets travel or are routed from the data plane 135 to the control plane 150." (JX-9001 ('668 patent) at 4:62-64.).

In the Underlying Investigation, the infringing [redacted], applied "an [redacted] to a control plane port entity implemented [redacted]" (ID at 196-97.). Thus, Arista's depiction of [redacted] as mere software does not directly rebut Cisco's evidence that that [redacted] functionality embedded in PEAC (implemented by [redacted]) is a "control plane port entity."

Arista failed to show that the '668 patent requires a "control plane port entity" to provide

PUBLIC VERSION

access to multiple independent processes, such as [REDACTED]. Arista proffers evidence that its agents are “[REDACTED] [REDACTED],” and that each [REDACTED] is “just [REDACTED] [REDACTED].” (Tr. (Snoeren) at 244:11-245:3; RPX-9000C; RX-9001C (Sweeney Witness Statement) at Q/A 159, 166-170).).

However, Arista’s own technical document belies such an interpretation of PEAC. (JX-9020 at 1000 (PEAC “restrict[s] the processing of [REDACTED] ... by the control plane processes that implement that [REDACTED],” where a [REDACTED] is equated with [REDACTED] (e.g., the [REDACTED])).

Moreover, as explained *supra* in Section IV.B.2.c, the asserted claims do not *require* that “control plane processes” operate as “independently executing processes.” (JX-9001 (’668 patent) at 3:42-45 (“*In accordance with* embodiments of the present invention, the control plane processes are implemented as independently executing processes.”) (emphasis added)). Similarly, nothing in the prosecution history of the ’668 patent suggests that that “control plane processes” [REDACTED] in terms of operating as “independently executing processes.” (JX-9003 (file wrapper for ’668 patent)); *see Rambus, Inc. v. Infineon Techs. AG*, 318 F.3d 1081, 1094-95 (Fed. Cir. 2003) (although portions of the written description referred to the term at issue as limiting the claimed invention to a preferred embodiment, “the remainder of the specification and the prosecution history shows that Rambus did not clearly disclaim or disavow such claim scope in this case”).

On at least one occasion, the ’668 patent refers to control plane processes not as [REDACTED] or independently executing processes, but as mere functions. (JX-9001 (’668 patent) at 5:36-38 (“An important aspect of the central switch engine 130 is that all packets destined to the control

plane 150 must pass through the central switch engine 130 prior to being routed to the *functions 155 in the control plane 150.*)” (emphasis added).). This comports with Cisco’s evidence that processes “may be a sequence of steps that comprise the substantive processing and management functionality of the control plane.” (Tr. (Almeroth) at 94:15-95:1 (2018 Hearing); Tr. (Snoeren) at 276:16-21 (2018 Hearing) (conceding that the claimed control plane process need not be a “Linux process”).).

Simply put, Arista’s characterization of each [REDACTED] as an [REDACTED] [REDACTED] does not directly rebut Cisco’s evidence that that [REDACTED] functionality embedded in PEAC ([REDACTED]) satisfies the asserted claims by acting as “a single access path required for packets to access” the substantive processing and management functionality of the control plane. (ID at 182.).

Accordingly, based on the weight of the evidence, Cisco has met its burden of proving by a preponderance of the evidence that the Redesigned Switches meet this limitation, such that PEAC’s [REDACTED] acts as a “control plane port entity” that provides access to “control plane processes” and also applies “control plane port services” in the form of [REDACTED]. See, e.g., *Cannon Rubber Ltd. v. The First Years, Inc.*, 163 F. App’x 870, 877 (Fed. Cir. 2005) (finding no authority “prohibiting a claim from reciting two limitations embodied by the same structural component.”).

c. Under Arista’s Incorrect Constructions of “Control Plane Processes” and “Control Plane Port Entity,” PEAC Satisfies This Limitation (d.i.) Under the DOE.

Assuming, *arguendo*, that the Commission agrees with Arista’s constructions of these

PUBLIC VERSION

terms and consequently finds that PEAC does not literally infringe the '668 patent, PEAC infringes under the DOE. "Infringement under the doctrine of equivalents may be found when the accused device contains an 'insubstantial' change from the claimed invention. Whether equivalency exists may be determined based on ... the 'triple identity' test, namely, whether the element of the accused device "performs substantially the same function in substantially the same way to obtain the same result." *TIP Sys., LLC v. Phillips & Brooks/Gladwin, Inc.*, 529 F.3d 1364, 1376-77 (Fed. Cir. 2008) (citations omitted). The essential inquiry here is whether "the accused product or process contain elements identical or equivalent to each claimed element of the patented invention[.]" (*Id.*)

According to Dr. Almeroth, there are no substantial differences between an arrangement where [REDACTED] [REDACTED] (as PEAC infringes under a proper reading of the claim language), and an arrangement where [REDACTED] [REDACTED] (under Arista's erroneous reading of the claim language). (Tr. (Almeroth) at 101:7-15 (2018 Hearing)). Programming each [REDACTED] provides substantially the same function ([REDACTED] [REDACTED]), in substantially the same way ([REDACTED] [REDACTED]), to achieve substantially the same result (packets destined to the control plane processes are [REDACTED]). (*Id.*; see also CDX-9004-80.).

In response, Arista emphasized the operational differences between PEAC's [REDACTED] functionality ([REDACTED]) and filtering control plane packets using [REDACTED]

PUBLIC VERSION

ACL functionality (e.g., CP-ACL found to infringe in the Underlying Investigation). (RBr. at 31-32). According to Arista, PEAC allows an [redacted] determine whether a [redacted].” (RX-9001C (Sweeney Witness Statement) at Q/A 158, 174.). PEAC “has [redacted] [redacted].” (Tr. (Snoeren) at 243:2-12 (2018 Hearing)). Consequently, “PEAC does not [redacted]. (RX-9001C (Sweeney Witness Statement) at Q/A 158, 181; (Tr. (Snoeren) at 243:2-12 (2018 Hearing)). Thus, PEAC does not provide [redacted]. (*Id.*).

While Arista’s evidence establishes that PEAC’s [redacted] approach differs from using [redacted] ACL functionality in several ways, Arista failed to demonstrate that these differences are substantial. *TIP Sys.*, 529 F.3d at 1376-77 (“Whether equivalency exists may be determined based on the ‘insubstantial differences’ test”).

Although each [redacted] contains an [redacted] of PEAC, and thus can provide [redacted] is applied to control plane packets, there is still some [redacted] because each PEAC [redacted] [redacted] control plane packets. (Tr. (Almeroth) at 166:1-22 (2018 Hearing); RX-9001C (Sweeney Witness Statement) at Q/A 210.). Moreover, it is telling that while Arista argues that “[i]n PEAC “[y]ou’ve [redacted],” Arista failed to provide any evidence that such [redacted]. (RX-9001C (Sweeney Witness Statement) at Q/A 158, 181; Tr. (Snoeren) at 243:2-12 (2018 Hearing); (JX-9001 (’668 patent) at 1:58-64 (“DoS attacks are thus commonly directed at control

plane service functions that reside on route processors such as routers, switches, fire-walls and the like, since they are the most likely to cause widespread disruption when they fail.”). By [REDACTED], PEAC performs the same function and obtains the same result as the claimed invention: PEAC [REDACTED] [REDACTED], just as in the '668 patent. (Tr. (Almeroth) at 100:25-101:15 (“the result is the same ... [REDACTED] [REDACTED]”).

Dr. Snoeren contended that if PEAC is covered by Cisco’s DOE argument, the prior art is also ensnared namely, “Gigaswitch” and “ExtremeWare” references. (Tr. (Snoeren) at 250:22-252:11 (2018 Hearing); RX-9010 (Digital Gigaswitch/Router User Reference Manual, 1999) at 243-244; RX-9074 (ExtremeWare User Guide) at ANI-945M-0005595). “A doctrine of equivalents theory cannot be asserted if it will encompass or ‘ensnare’ the prior art.” *Jang v. Boston Sci. Corp.*, 872 F.3d 1275, 1287 (Fed. Cir. 2017).

Arista’s ensnarement argument is incomplete. As an initial matter, the argument is waived, because it was not distinctly raised in Arista’s Pre-Hearing Brief. (RPBr. at 47 (raising ensnarement only with respect to “destined to”); Ground Rule 10.1.). While Dr. Snoeren testified that Gigaswitch “implemented control plane processes to actually have service ACLs” and that ExtremeWare “describes implementing service ACLs inside of a control plane process,” Dr. Almeroth testified that the Gigaswitch and ExtremeWare references lack implementation details that describe whether the disclosed service ACLs were located within operating system “processes” separate from the purported control plane “processes.” (Tr. (Almeroth) at 101:24-102:4 (2018 Hearing); Tr. (Snoeren) at 251:11-20 (2018 Hearing) (“there’s no technical space

between PEAC and what this is describing”).).

During the Hearing, Arista devoted a mere 33 lines of testimony, hardly more than a page, to the specific operations of Gigaswitch and ExtremeWare. (*Id.* at 251:8-252:15.).

Arista’s corresponding demonstrative slide cites to exhibits without sufficient analysis of why ensnarement applies. (RDX-9001C-19; RDX-9001C-20.).

For Arista’s DOE argument to ensnare the prior art, more evidence on “Gigaswitch” and “ExtremeWare” was required. Arista failed to provide the necessary evidence to support its ensnarement defense.

vi. Subsection (d.ii): “[operating] the control plane port services operate on packets received from specific, predetermined physical ports and destined to the collection of control plane processes in a way that is independent of the [individual] physical port interfaces [physical port interface configuration] and [port] services applied thereto”

a. PDP Satisfies This Limitation (d.ii.) Under the Plain and Ordinary Meaning of “Independent of”

The core dispute between Cisco and Arista over the presence of this limitation in the Redesigned Switches concerns the proper construction of “independent of.” As explained in Section IV.B.1.b, *supra*, “independent of” should be accorded its plain and ordinary meaning.

While the Commission stated that the “independent of” limitation means that control plane port services to be “applied after the control plane packets exit the physical ports and services applied thereto,” for reasons explained *supra*, it did not provide a new construction that diverged from that provided in the *Markman* Order or applied in the ID. Instead, resurrecting language from Cisco’s infringement argument for different Redesigned Switches in the

PUBLIC VERSION

Underlying Investigation, the Commission articulated a condition that was sufficient but not necessary to satisfy the “independent of” claim limitation.

Cisco presented evidence that the Redesigned Switches with PDP functionality meet this limitation under the plain and ordinary meaning of “independent of.” (CBr. at 23-25.). Dr. Almeroth offered his opinion that PDP policers [REDACTED] provide control plane port services and that such services operate in a way that is independent of physical port interfaces and services applied thereto. (Tr. (Almeroth) at 88:23-90:6, 89:5-12 (2018 Hearing).).

There is additional evidence that PDP operates independently of physical ports and their services. (Tr. (Snoeren) at 213:6-10 (“there are packets that [REDACTED] determines aren't actually going to go anywhere, [REDACTED] is going to drop them but PDP [REDACTED] because [REDACTED].”), 16-22 ([REDACTED] is configured to “[REDACTED]” compared to PDP); CX-9018C at 6-13 (PDP configuration); JX-9008C at 6-13 (PDP Spec); JX-9020 at 743-44 ([REDACTED] configuration), 1211 (QoS configuration); CX-9114C (discussing interactions between [REDACTED] protocol packets, such as [REDACTED] packets, that “are [REDACTED] by the pipeline with a [REDACTED]”).).

Arista did not rebut this evidence. Instead, it pointed out that the asserted claims do not address how PDP is configured, but how PDP actually operates *vis-à-vis* physical port services. (RRBr. at 21; Tr. (Almeroth) at 89:3-22 (2018 Hearing) (PDP is [REDACTED] other [REDACTED] services).). However, this is an unavailing argument given that Arista’s PDP Specification explains that, in operation, PDP’s [REDACTED]

[redacted]. (JX-9008C (PDP Spec) at 17 (“[W]e [redacted] applying [redacted].”), 22 (“If both [redacted] provide [redacted] [redacted]”).).

Accordingly, based on the weight of the evidence, Cisco has met its burden of proving by a preponderance of the evidence that the Redesigned Switches with PDP functionality meet this limitation, such that PDP policers [redacted] are control plane port services and that such services operate in a way that is independent of physical port interfaces and services applied thereto.

For the reasons set forth above, Cisco has met its burden proving by a preponderance of the evidence that Redesigned Switches with PDP functionality infringe claims 1 and 55 of the '668 patent.

b. Under Arista’s Incorrect Construction of “Independent of,” PDP Does Not Satisfy This Limitation (d.ii.) Under the DOE

Assuming, *arguendo*, that the Commission agrees with Arista’s narrow construction of “independent of,” and consequently finds that PDP does not literally infringe the '668 patent, PDP does not infringe under the DOE. This finding would be (and is) consistent with Arista’s evidence that it invested [redacted] designing PDP, and its assertion that it designed PDP to use prior art techniques described in the '668 patent. (RBr. at 8 (citing RX-9001C (Sweeney Witness Statement) at Q/A 18-20, 40-42, 43-51, 127-137).).

While, as compared to the claimed invention, PDP performs substantially the same function— [redacted] to achieve substantially the same result protection

[redacted], it does not do so in substantially the same way as the claimed invention. (RBr. at 22 (“it is true that PDP will police [redacted] ... and PDP ... protects ... [redacted].”). Specifically, PDP uses the same [redacted], allowing PDP to police or count [redacted] packets. (RX-9001C (Sweeney Witness Statement) at Q/A 34, 119-23, 133).). Acting on [redacted] packets, primarily at the [redacted], is nearly the antithesis of acting on [redacted] [redacted]. See *Brilliant Instr., Inc. v. GuideTech, LLC*, 707 F.3d 1342, 1347 (Fed. Cir. 2013) (“The vitiating concept⁴⁵ [that no reasonable jury could determine two elements to be equivalent] has its clearest application ‘where the accused device contain[s] the antithesis of the claimed structure’ . . . This makes sense; two elements likely are not insubstantially different when they are polar opposites.”).

The [redacted] location of PDP has advantages and disadvantages. It allows PDP to [redacted] [redacted]. (RX-9001C (Sweeney Witness Statement) at Q/A 34, 133; Tr. (Snoeren) at 236:13-237-7 (2018 Hearing).). Like the prior art, PDP is [redacted] [redacted] until the [redacted]. (RX-9001C (Sweeney Witness Statement) at Q/A 86, 88, 90, 134).).

⁴⁵ “Vitiating” is not an exception to the doctrine of equivalents, but instead a legal determination that “the evidence is such that no reasonable jury could determine two elements to be equivalent.” *Deere & Co. v. Bush Hog, LLC*, 703 F.3d 1349, 1356 (Fed. Cir. 2012).

Because PDP occupies [redacted] real estate, in theory, [redacted]
[redacted],” when
there is not enough [redacted]
[redacted]. (*Id.* at Q/A 137; Tr. (Snoeren) at 234:13-235:7 (2018
Hearing).).

Finally, PDP is necessarily configured [redacted], which is easy to achieve
using default configurations. However, for non-default settings, an administrator must [redacted]
[redacted]. (RX-9001C (Sweeney Witness Statement) at Q/A 65; RX9200
(showing configuration change from [redacted] applied to [redacted] JX-
9016C (PDP Spec, version 1.0.1) at 335, 338-339, 344.).

By contrast, under Arista’s construction of “independent of,” the claimed invention
sequesters and applies port services to control plane packets after they exit “the physical ports
and services applied thereto,” allowing an administrator, for example, to apply a control plane
service policy “to the single control plane port rather than modifying the configuration on all
[physical] ports.” (JX-9001 (’668 patent) at 4:10-12.).

Cisco’s argument that the DOE applies in lieu of literal infringement is misplaced. Cisco
focuses on [redacted]
[redacted] and asserts that [redacted] is equivalent to the
application of “control plane port services” to control plane packets after exiting “the physical
ports and services applied thereto.” (CBr. at 24 (citing (Tr. (Almeroth) at 91:12-16 (2018
Hearing) (“[t]he way that PDP [redacted]
[redacted] is insubstantially different from simply [redacted] to

[redacted].”).).

While Cisco’s analysis notes that, under either approach, control plane packets get forwarded to the control plane or are dropped, Cisco’s comparison fails to account for the markedly different mechanisms by which this occurs, as reflected in the operational pros and cons of each approach, addressed above. (CBr. at 24.). For example, PDP operates on [redacted] [redacted], and administrators must [redacted] basis. (RX-9001C (Sweeney Witness Statement) at Q/A 65; RX9200 (showing configuration change from [redacted])); JX-9016C (PDP Spec, version 1.0.1) at 335, 338-339, 344.).

As the ’668 patent teaches, this is not the case where “independent of” means after control plane packets have exited “the physical ports and services applied thereto.” (JX-9001 (’668 patent) at 4:10-12 (allowing an administrator to apply a control plane service policy “to the single control plane port rather than modifying the configuration on all [physical] ports.”)).

Moreover, because PDP is a [redacted], policing results are [redacted]

[redacted]

[redacted]

operates on the packet.” (Tr. (Snoeren) at 220:15-25, 228:8-229:3 (2018 Hearing)). This is but one example of how, under Arista’s construction of “independent of,” the claimed invention escapes many, if not all, of the shortcomings associated with operating as a physical port service (listed above) and, in so doing, protects the control plane in a different way than PDP does.

If the Commission finds that the DOE applies here, it does not, as Arista suggests, ensnare the prior art.⁴⁶ During the Hearing, Arista did not specifically address the Ferguson reference (U.S. Patent No. 7,215,637) that constituted its ensnarement defense thereby waiving its right to do so now. (RPBr. at 35-36, 49 50.). Arista's Pre-Hearing Brief did not mention prior art other than Ferguson as a basis for that defense. Therefore, any ensnarement argument based on Arista's vague references to other prior art is waived pursuant to Ground Rule 10.1.

c. PEAC Satisfies This Limitation (d.ii.) Under the Plain and Ordinary Meaning of "Destined to"

Cisco presented evidence that the Redesigned Switches with PEAC functionality meet this limitation. (CBr. at 32.). PEAC provides control plane port services that operate on packets received from specific, predetermined physical ports and destined to the collection of control plane processes in a way that is independent of the physical ports and physical port services applied thereto. (Tr. (Almeroth) at 100:11-20 (2018 Hearing); JX-9009C.). PEAC implements control plane port services through various [REDACTED]. (Tr. (Almeroth) at 69:2-12 (2018 Hearing).). These [REDACTED] operate on packets destined to control plane processes [REDACTED]. (*Id.* at 97:7-98:5.). Arista's documentation shows

⁴⁶ Arista additionally argues but fails to demonstrate that Dr. Almeroth's opinions on PDP infringement under DOE are "too superficial to support Cisco's burden." (RBr. at 22 (citing *Regents of University of Minnesota v. AGA Medical Corp.*, 717 F.3d 929, 941 (Fed. Cir. 2013))). In *Regents*, an expert's testimony on DOE was discarded because it "fail[ed] to offer any evidence or analysis" and instead was "a conclusion supported by no explanation or reasoning." *Regents*, 717 F.3d at 941. That is not the situation here. Dr. Almeroth's opinions on PDP infringement under DOE, while sparse and not persuasive, do include explanation and reasoning and are supported by Arista's technical documents on the operation of PDP. (Tr. (Almeroth) at 90:23-91:20 (2018 Hearing); JX-9016C (PDP Spec, version 1.0.1)).

that PEAC [redacted] are configured, and operate, independently from [redacted] [redacted]. (JX-9020 at 1000 ([redacted] configuration); 743-44 ([redacted] configuration), 1211 ([redacted] configuration)); Tr. (Almeroth) at 89:17-90:6). Finally, these control plane port services operate on packets [redacted]. (Tr. (Almeroth) at 97:22-98:5, 100:11-20 (“slide 79, it describes how I characterized PEAC as being implemented as a [redacted]”); CX-9201C at 78:7-21.).

In rebuttal, Arista failed to provide evidence that PEAC control plane port services do not operate on packets “destined to” the control plane processes disclosed in the ‘688 patent. Because PEAC operates [redacted], Arista argued that, when control plane packets reach PEAC, they have [redacted].” Yet, what distinguishes “control plane processes” in the ‘668 patent (and imbues them with importance) is what they do and, according to the patent “control plane processes” acquire information that dictates “packet forwarding behavior of the data plane elements.” (JX-9001 (‘668 patent) at 3:35-38.).

Cisco presented evidence that PEAC [redacted] [redacted] that acquire information that dictates “packet forwarding behavior of the data plane elements.” (CDX-9004C-78; JX-9009C.). When packets arrive at a [redacted], and undergo PEAC processing, they are still destined to such control plane processes. (Tr. (Almeroth) at 97:22-98:6; CX-9201C (Holbrook Dep.) at 78:7-21 (“[T]he way an instance of PEAC works, to my understanding, is the [redacted] has been [redacted] [redacted].”).

Figure 19: Cisco's Depiction of PEAC's [redacted] Role

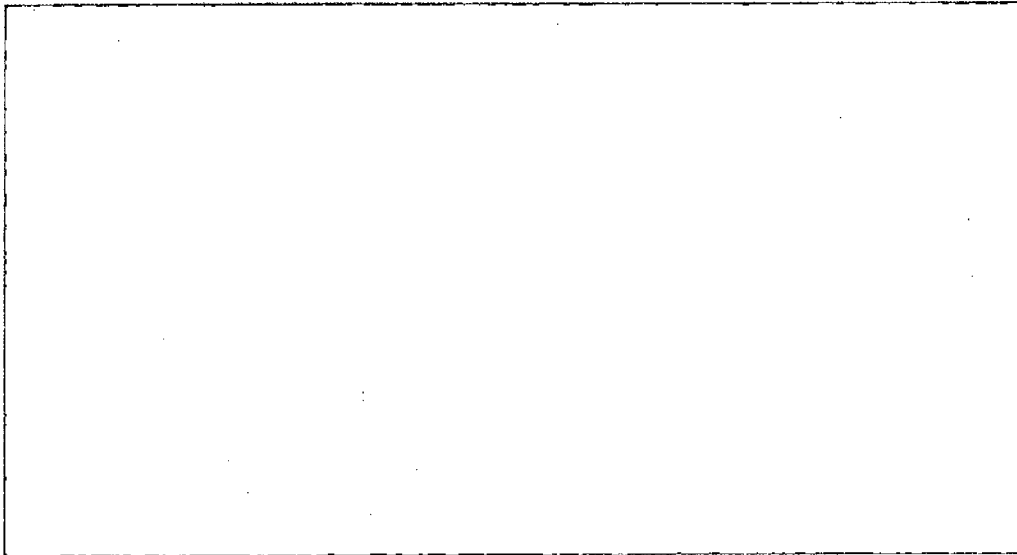

(CDX-9004C-78 (presented by Dr. Almeroth during the 2018 Hearing)).

Cisco presented evidence that PEAC operates on [redacted]

[redacted] acquire from them information that dictates [redacted]

[redacted].” Arista has presented no evidence to the contrary. (JX-9009C at 1

(ARISTA-945CBP-00000058) (PEAC “[redacted]

[redacted]

[redacted]

[redacted]

[redacted]

process”).).

Relying upon Dr. Snoeren’s testimony, Arista attempted to change the claim limitation at issue to require control plane packets “destined to the [redacted],” not a “collection of control plane processes.” (Tr. (Snoeren) at 241:13-25 (conflating [redacted] and “control plane

processes”). While PEAC exists [redacted] and thus operates on [redacted] [redacted], this nuance is immaterial because the asserted claims at issue do not require control plane port services acting on packets destined to [redacted]. (*Id.*)

Accordingly, based on the weight of the evidence, Cisco has met its burden of proving by a preponderance of the evidence that the Redesigned Switches with PEAC functionality meet this limitation, such that PEAC operates as control plane port service by applying service ACLs to control plane packets *destined to* control plane processes in a way that is independent of physical port interfaces and services applied thereto.

d. Under Arista’s Incorrect Construction of “Destined to,” PEAC Satisfies This Limitation (d.ii.) Under the DOE

Assuming, *arguendo*, that the Commission agrees with Arista’s interpretation of “destined to”⁴⁷ and consequently finds that PEAC does not literally infringe the ’668 patent, PEAC nonetheless infringes under the DOE. This is because the claimed invention and PEAC functionality in the Redesigned Switches perform the same function ([redacted] [redacted]), in substantially the same way ([redacted] [redacted]), with the same result ([redacted] [redacted]). (Tr. (Almeroth) at 101:7-15 (2018 Hearing); JX-9020 at 1000.). Merely moving a control plane port service [redacted] (as in

⁴⁷ Arista argued that “destined to” means “not yet arrived at” and that PEAC operates on packets that have [redacted] [redacted]. (Tr. (Snoeren) at 241:13-16, 243:22-23 (2018 Hearing); RPBr. at 39-41.).

[redacted]) to [redacted] (as in PEAC) is insubstantially different with respect to this element of the independent claims. (Tr. (Almeroth) at 100:25-101:6 (2018 Hearing)).

While Arista's evidence establishes that PEAC's [redacted] differs from using [redacted] ACL functionality in several ways, as discussed in Section IV.A.2 *supra*, Arista fails to demonstrate here that these differences are substantial.⁴⁸ Indeed, by [redacted], PEAC performs the same function and obtains the same result as the claimed invention: it [redacted] [redacted] [redacted]. (Tr. (Almeroth) at 100:25-101:15 (2018 Hearing) ("the result is the same ... [redacted] [redacted]").⁴⁹

Dr. Snoeren contended that Cisco's DOE position on PEAC in general, and this claim limitation specifically, ensnares prior art—namely, “Gigaswitch” and “ExtremeWare” references. (Tr. (Snoeren) at 250:22-252:11 (2018 Hearing)). Yet, as explained *supra* in this section, for Cisco's DOE argument to ensnare the prior art, Arista would have had to provide more evidence about the operational characteristics of “Gigaswitch” and “ExtremeWare.”

⁴⁸ Arista's vitiation argument is misplaced. (RBr. at 32.). Policing control plane packets [redacted] [redacted] is not the antithesis of policing control plane packets [redacted]. See *Brilliant Instr., Inc.*, 707 F.3d at 1347 (“The vitiation concept [that no reasonable jury could determine two elements to be equivalent] has its clearest application ‘where the accused device contain[s] the antithesis of the claimed structure’ . . . This makes sense; two elements likely are not insubstantially different when they are polar opposites.”).

⁴⁹ Arista argues but fails to demonstrate that Dr. Almeroth's opinions on PEAC infringement under DOE are “too superficial to support Cisco's burden.” (RBr. at 31 (citing *Regents of University of Minnesota*, 717 F.3d at 941)). Dr. Almeroth's opinions on PEAC infringement under DOE, while sparse, do include explanation and reasoning and are supported by Arista's technical documents on the operation of PEAC. (Tr. (Almeroth) at 100:25-101:15 (2018 Hearing); JX-9020 at 1000.).

PUBLIC VERSION

For the reasons set forth above, Cisco has met its burden and established by a preponderance of the evidence that Redesigned Switches with PEAC functionality infringe claim 1 and 55 of the '668 patent.

2. All Asserted Dependent Claims of the '668 Patent Cover the Redesigned Switches

According to Arista, PDP and PEAC do not infringe the asserted dependent claims of '668 patent only because these features do not practice the corresponding independent claims. (RBr. at 24, 32.). Arista did not provide a specific analysis of the dependent claims. Thus, pursuant to Ground Rule 10.1, Arista has waived any arguments that PDP or PEAC do not practice the additional limitations of the dependent claims.

a) Dependent Claim 2 of the '668 Patent

- i. A device as in claim 1 wherein the control plane processes are accessible through a control plane port on the internetworking device, such that control plane packets originating at a plurality of physical ports and destined to one of a plurality of control plane processes are first processed through the control plane port, rather than to individual control plane processes.*

Cisco asserted that the Redesigned Switches with PDP or PEAC functionality meet the additional limitations set forth in claim 2 of the '668 patent. (CBr. at 32.). These Switches practice dependent claim 2, by including a control plane port through which the control plane processes are accessible. (Tr. (Almeroth) at 102:12-19 (2018 Hearing); CX-9003C at 3; CX-9194C at 78:6-11.).

In the absence of any rebuttal evidence from Arista, Cisco has met its burden of proving by a preponderance of the evidence that Redesigned Switches with PDP or PEAC functionality

meet the additional limitations recited in claim 2 of the '668 patent.

b) Dependent Claim 4 of the '668 Patent

- i. A device as in claim 3 wherein the control plane port services are applied after a transit packet forwarding decision is made.*

Cisco asserted that the Redesigned Switches with PDP or PEAC functionality meet the additional limitation set forth in claim 4 (and claim 3 upon which it relies). (CBr. at 27.). These Switches practice claim 4 “by applying control plane port services after a transit packet forwarding decision is made.” (Tr. (Almeroth) at 102:20-103:4 (2018 Hearing); CX-9027; CX-9089 at 5.).

In the absence of any rebuttal evidence from Arista, Cisco has met its burden and demonstrated by a preponderance of the evidence that Redesigned Switches with PDP or PEAC functionality meet the additional limitations recited in claim 4 of the '668 patent.

c) Dependent Claim 5 of the '668 Patent

- i. A device as in claim 3 wherein Layer 2 control packets are identified and forwarded to the control plane port.*

Cisco asserted that the Redesigned Switches with PDP functionality meet the additional limitation set forth in claim 5 (and claim 3 upon which it relies). (CBr. at 33.). These Switches practice claim 5 by “identifying Layer 2 control packets and forwarding such packets to the control plane.” (Tr. (Almeroth) at 103:5-14 (2018 Hearing); JX-9008C at 9-12.).

In the absence of any rebuttal evidence from Arista, Cisco has met its burden of proving by a preponderance of the evidence that Redesigned Switches with PDP functionality meet the additional limitations recited in claim 5 of the '668 patent.

d) Dependent Claim 7 of the '668 Patent

- i. A device as in claim 1 wherein the control plane processes are distributed across multiple processors.*

Cisco asserted that the Redesigned Switches with PDP or PEAC functionality meet the additional limitation set forth in claim 7. (CBr. at 33.). These Switches infringe claim 7 through the distribution of control plane processes across multiple processors. (Tr. (Almeroth) at 103:15-23; CX-9027 at 2.).

In the absence of any rebuttal evidence from Arista, Cisco has met its burden of proving by a preponderance of the evidence that Redesigned Switches with PDP or PEAC functionality meet the additional limitation recited in claim 7 of the '668 patent.

e) Dependent Claim 8 of the '668 Patent

- i. A device as in claim 1 wherein the control plane port services are implemented as an aggregate control plane function applied to packets received from multiple physical ports on the internetworking device.*

Cisco asserted that the Redesigned Switches with PEAC functionality meet the additional limitation set forth in claim 8. (CBr. at 33.). These Switches infringe claim 8 through aggregate application of control plane port services. (Tr. (Almeroth) at 104:17-105:24 (2018 Hearing).).

In the absence of any rebuttal evidence from Arista, Cisco has met its burden of proving by a preponderance of the evidence that Redesigned Switches with PEAC functionality meet the additional limitations recited in claim 8 of the '668 patent.

f) Dependent Claim 10 of the '668 Patent

- i. A device as in claim 1 wherein the control plane port services are implemented as distributed control plane port services, and wherein the distributed control plane port services are*

applied only to the packets received from the specific, pre-determined physical ports.

Cisco asserted that the Redesigned Switches with PDP functionality meet the additional limitation set forth in claim 10. (CBr. at 33.). These Redesigned Switches with PDP infringe claim 10 through the features implementations as distributed control plane functions. (Tr. (Almeroth) at 103:24-105:24 (2018 Hearing); CX-9090C at 3, 7; CX-9091C at 1.).

In the absence of any rebuttal evidence from Arista, Cisco has met its burden of proving by a preponderance of the evidence that Redesigned Switches with PDP functionality meet the additional limitations recited in claim 10 of the '668 patent.

g) Dependent Claim 13 of the '668 Patent

i. A device as in claim 10 wherein one or more distributed switch engines deliver packets to the control plane port.

Cisco asserted that the Redesigned Switches with PDP functionality meet the additional limitation set forth in claim 13 (which depends from claim 10). (CBr. at 33.). These Redesigned Switches infringe claim 13 by included distributed switch engines within the that deliver packets to the control plane port. (Tr. (Almeroth) at 104:25-105:6 (2018 Hearing); CX-9027 at 7.).

In the absence of any rebuttal evidence from Arista, Cisco has met its burden of proving by a preponderance of the evidence that Redesigned Switches with PDP functionality meet the additional limitations recited in claim 13 of the '668 patent.

h) Dependent Claim 18 of the '668 Patent

i. A device as in claim 1 where in control plane port services are controlled and configured as unique entity, separate from physical port services.

PUBLIC VERSION

Cisco asserted that the Redesigned Switches with PDP or PEAC functionality meet the additional limitation set forth in claim 18. (CBr. at 33.). These Redesigned Switches infringe claim 18 by being controllable and configurable as a unique entity. (Tr. (Almeroth) at 105:7-12 (2018 Hearing); JX-9008C at 15-16, 20-21, 24, 26; JX-9009C at 1.).

In the absence of any rebuttal evidence from Arista, Cisco has met its burden of proving by a preponderance of the evidence that Redesigned Switches with PDP or PEAC functionality meet the additional limitations recited in claim 18 of the '668 patent.

i) Dependent Claim 56 of the '668 Patent

- i. A medium as in claim 55 wherein the control plane port processes packets originating at a plurality of physical ports, the method additionally comprising: passing packets through the control plane port, rather than directly from the physical ports to individual control plane processes.*

Cisco asserted that the Redesigned Switches with PDP or PEAC functionality meet the additional limitation set forth in claim 56. (CBr. at 33.). These Redesigned Switches infringe claim 56 by passing packets through control plane ports rather than having packets deliver directly to the control plane processes as part of instructions provided by . (Tr. (Almeroth) at 105:13-106:5 (2018 Hearing); CX-9003C at 3; CX-9194C at 78:6-11.).

In the absence of any rebuttal evidence from Arista, Cisco has met its burden of proving by a preponderance of the evidence that Redesigned Switches with PDP or PEAC functionality meet the additional limitations recited in claim 56 of the '668 patent.

j) Dependent Claim 64 of the '668 Patent

- i. A medium as in claim 55 additionally comprising: applying distributed control plane port services only to the packets received from the specific, pre-determined physical ports.*

Cisco asserted that the Redesigned Switches with PDP functionality meet the additional limitation set forth in claim 64. (CBr. at 33.). These Redesigned Switches infringe claim 64 by implementing [] instructions to apply distributed control plane port services in the form of []. (Tr. (Almeroth) at 106:6-14 (2018 Hearing); CX-9090C at 3, 7; CX-9091C at 1; JX-9008C at 6.).

In the absence of any rebuttal evidence from Arista, Cisco has met its burden of proving by a preponderance of the evidence that Redesigned Switches with PDP functionality meet the additional limitations recited in claim 56 of the '668 patent.

V. The Redesigned Switches Do Not Infringe the '577 Patent

Cisco accused two features of the Redesigned Switches of infringing the '577 patent: (1) [] ACL" functionality; and (2) filtered port mirroring. However, neither of these features practices claims 1, 7, 9-10, and 15 of the '577 patent. Therefore, Arista's Redesigned Switches do not infringe the '577 patent.

A. Accused Functionality

1. [] ACL" Functionality

Arista has [] [] ACL" functionality found to infringe in the Underlying Investigation. (Tr. (Black) at 291:2-9 (2018 Hearing).). This revelation contradicts Arista's representations to CBP and the Federal Circuit that the infringing functionality [] [] []. (CX-9163C at 2 ("Arista's redesign, when implemented, would [] ACL feature [] [] its switch products").).

Arista's Redesigned Switches still include, for example, [REDACTED],⁵⁰ hardware required to [REDACTED] (such as [REDACTED]), and the same "ip access list" CLI command used to configure [REDACTED] ACLs. (Tr. (Almeroth) at 111:21-112:19, 117:23-118:3 (2018 Hearing); CX-9201C at 40:19-41:9, 108:6-9).

Both Dr. Almeroth for Cisco, and Dr. Black for Arista, tested the Redesigned Switches and confirmed that they do not [REDACTED] ACL" functionality. (Tr. (Almeroth) at 112:25-113:5, 177:10-179:16; Tr. (Black) at 290:14-291:9; RDX9000C-9.). When they attempted to configure this functionality on a Redesigned Switch, they [REDACTED] [REDACTED]." (*Id.*; see also RX-9001C (Sweeney Witness Statement) at Q/A 15, 27, 246-47; CPX-9047C ([REDACTED]); JX-9014C at 1.).

Arista's Redesigned Switches should have foreclosed any possibility of continued infringement of the '577 patent. Yet, Cisco's expert, Dr. Almeroth, [REDACTED] of a Redesigned Switch to [REDACTED] of the switch and [REDACTED] [REDACTED]. (Tr. (Black) at 293:21-296:2; RDX9000C-13.). In so doing, Dr. Almeroth [REDACTED] the Redesigned EOS (version [REDACTED]) that [REDACTED]. (*Id.*). According to Cisco, "Dr. Almeroth did not break any 'security mechanism,' access any locked files, or otherwise rely on confidential information to [REDACTED]." (CBr. at

⁵⁰ This is true only for Redesigned Switches running Redesigned EOS, not Hardened Redesigned EOS. (Tr. (Black) at 297:9-19; RX-9001C (Sweeney Witness Statement) at Q/A 347; Tr. (Almeroth) at 183:23-184:13.).

36.). Instead, Dr. Almeroth did what, in theory, Cisco claims [redacted] could do: that EOS is “an ‘open’ system allowing users complete access to configure, customize, and program EOS.” (CX-9129 at 1 (“It’s okay to leave the door unlocked”); JX-9017 at 1 (“Arista’s EOS makes it possible to provide customization”); Tr. (Almeroth) at 113:10-114:23 (2018 Hearing)).

The Parties debate the extent to which an Arista customer could, or would want to, [redacted] as Dr. Almeroth. According to Arista, and as not disputed by Cisco, Dr. Almeroth’s [redacted] was unsupported and thus, if repeated, could [redacted] [redacted]. (Tr. (Black) at 333:2-17; RX-9001C (Sweeney Witness Statement) at Q/A 344-47.). Yet, Cisco contended that Dr. Almeroth’s [redacted] was based on publicly-accessible files and publicly-available user instructions from Arista. (CBr. at 36 (citing CX-9129 at 1; JX-9017 at 1; Tr. (Almeroth) at 113:10-114:23 (2018 Hearing))). Without addressing whether Dr. Almeroth’s access to highly confidential discovery in this Investigation may have affected his ability to accomplish the [redacted] Cisco flatly asserted that “Dr. Almeroth followed the Arista configuration instructions to find a [redacted] [redacted]” (*Id.* (citing Tr. (Almeroth) at 113:10-117:22 (2018 Hearing))).

Arista strongly challenged Cisco’s characterization of the “[redacted]” of Arista’s Redesigned Switches. According to Arista’s expert, Dr. Black, the latest “Hardened Redesigned EOS” ([redacted]) thwarts Dr. Almeroth’s “[redacted].” (Tr. (Black) at 297:9-19.). As for Redesigned EOS, which Dr. Almeroth “[redacted],” Arista alleged without providing direct evidence that “Dr. Almeroth relied on his [redacted] [redacted],” which is not shared with customers.

(Tr. (Black) at 296:3-23; RX-9001C (Sweeney Witness Statement) at Q/A 336, 347; CX-9201C (Holbrook Dep.) at 85:9-86:1, 284:13-18.). Arista also concluded, again without direct evidence, that “Dr. Almeroth relied on Arista’s [REDACTED] [REDACTED] [REDACTED] ACL” functionality.⁵¹ (RBr. at 37 (citing Tr. (Almeroth) at 183:3-7 (2018 Hearing); Tr. (Black) at 296:3-297:8; CPX-9047C [REDACTED]); CPX-9048C [REDACTED]).).

2. Filtered Port Mirroring Functionality

Cisco did not specifically accuse filtered port mirroring of infringing the '577 patent in the Underlying Investigation. (Initial Post-Hearing Brief Concerning the '577 and '853 Patents (UI) at 22.). However, there is no dispute that the filtered port mirroring functionality was present in Arista’s legacy switches accused in the Underlying Investigation. It remains present in Arista’s Redesigned Switches which Cisco has accused of infringement in this Modification Proceeding 2. (CBr. at 40; RBr. at 40; Arista’s Motion *in Limine* to Preclude Evidence and Argument That Filtered Port Mirroring Infringes the Asserted Claims of the '557 Patent at 2 (Motion Docket No. 945-060 (Jan. 5, 2018))).).

⁵¹ According to Dr. Black, Dr. Almeroth was wrong to opine that [REDACTED]—the critical file that controls whether a switch will [REDACTED] ACLs is exposed to users on a switch. (Tr. (Almeroth) at 183:10-15 (2018 Hearing); Tr. (Black) at 296:24-297:8.). This is strong rebuttal evidence against Cisco’s contention that Dr. Almeroth’s “[REDACTED]” demonstrates what any Arista customer could do. (CBr. at 36.).

An overview of how filtered port mirroring operates is necessary because the Parties dispute not whether filtered port mirroring was adequately removed from Redesigned Switches, as was the case with Arista's [REDACTED] ACL" functionality, but instead whether filtered port mirroring operates in a manner that infringes the '577 patent.

Filtered port mirroring is a feature in Arista's Redesigned Switches that creates a copy of selected packets passing through a port and sends the copy to one or more "mirror ports." (Tr. (Black) at 303:16- 304:3, 304:9-305:12; RX-9001C (Sweeney Witness Statement) at Q/A 294, 302-03.). The "filtered" in filtered port mirroring refers to the selection of packets for mirroring using an ACL. (*Id.*) If a packet is selected for mirroring, a Redesigned Switch [REDACTED] [REDACTED] to the mirror port. If a packet is not so selected, [REDACTED] because, conceptually, port mirroring requires two steps: [REDACTED] [REDACTED]. (Tr. (Black) at 303:16-304:3, 304:9-305:12; RX-9001C (Sweeney Witness Statement) at Q/A 306-12.). Filtered port mirroring does not [REDACTED]; instead it merely [REDACTED] packets that should not be mirrored. (*Id.*) Notwithstanding a mirroring determination, the original packet [REDACTED] [REDACTED] as if the filtered port mirroring feature did not exist. (*Id.*) Filtered port mirroring does not, and cannot, [REDACTED] [REDACTED]; it's only concern is mirroring. (Tr. (Almeroth) at 192:8-23 (2018 Hearing); Tr. (Black) at 303:16-304:3, 304:9-305:12; RX-9001C (Sweeney Witness Statement) at Q/A 306-12; CX-9201C (Holbrook Dep. Tr.) at 282:5-284:12.).

Filtered port mirroring operates by initiating a port mirroring session. (JX-9020 at 742.). "A mirror session correlates a set of source ports to a [mirrored] destination port." (*Id.* at 740.).

Port mirroring ACLs then [REDACTED]. (Tr. (Almeroth) at 108:18-110:5, 118:22-120:11, 124:1-24, 190:11-24; Tr. (Black) at 328:16-329:6, 329:18-330:10.). The source device, destination device, or both, can be specified in the port mirroring ACL. (Tr. (Almeroth) at 108:13-25, 109:13-25, 120:15-121:8, 169:25-170:2 (2018 Hearing); CDX-9003C-10; Tr. (Black) at 332:2-10.).

Cisco emphasized the ways in which filtered port mirroring resembles the ACL functionality found to infringe the '577 patent in the Underlying Investigation. "Port mirroring ACLs are created through the same 'access list' command that was found in the 945 Investigation to generate the infringing [REDACTED] ACLs." (CBr. at 41 (comparing JX-9020 at 989 (using the "ip access list" command to configure an ACL) with *id.* at 742 (using the "ip access-list" command to configure an ACL with a port mirroring session)); Tr. (Almeroth) at 122:1-16 (2018 Hearing); CX-9172C at 41 (showing the accused functionality configured through the "ip access-list" command).). "Port mirroring ACLs also [REDACTED] as the features Arista acknowledges were found to infringe." (*Id.* (citing Tr. (Almeroth) at 123:9-25, 126:7-21 (2018 Hearing); CPX-9087C at 00263.)). Finally, "port mirroring ACLs use the same infringing [REDACTED]." (*Id.* (citing Tr. (Almeroth) at 122:23-123:8 (2018 Hearing); CX-9100C (chip specification) at 870; CX-9201C at 109:1-9 (port mirroring [REDACTED])).).

Arista argued that these similarities between infringing [REDACTED] ACL" functionality and filtered port mirroring are misleading. Arista claimed that while the use of ACLs by filtered port mirroring offers superficial appeal in terms of a finding of infringement, it is well known in the industry that, despite their full name (access control lists), ACLs are used

PUBLIC VERSION

for more than “access control.” (RDX-9000C-8 (Cisco Support Forum distinguishing between the use of the terms “ACL” and “access control” and noting that “ACLs are more than just access control”).).

For example, Dr. David Maltz, [REDACTED], one of [REDACTED], distinguished between two kinds of access lists those used for access control, which he called “source-destination permit-deny ACLs” and those used merely to select packets for other features “packet classification ACLs.” (JX-9023C (Maltz Decl.) at 2.). Dr. Maltz described filtered port mirroring as a “packet classification ACL” and not a “permit-deny” ACL. (*See id.* at 10 (“[REDACTED] specifies a packet [REDACTED] with an action to [REDACTED] into a [REDACTED].”); *see also* Tr. (Black) at 310:10-311:2.).

To clarify operation of filtered port mirroring, Dr. Black compared the contents of the [REDACTED] in Arista’s Redesigned Switches when a [REDACTED] was applied against those contents when filtered port mirroring was applied. (Tr. (Black) at 306:18-308:10; RDX9000C-31-33.).

When a “source-destination permit-deny ACL” was applied, the contents of the [REDACTED] showed that the “actions” to be taken [REDACTED] were “[REDACTED]”—that is, the sender is [REDACTED]. (Tr. (Black) at 322:25-323:2 (“Q. If it's [REDACTED] [REDACTED] correct? A. That's correct.”)).

Figure 20: Arista's Depiction of Test Output Applying [REDACTED]

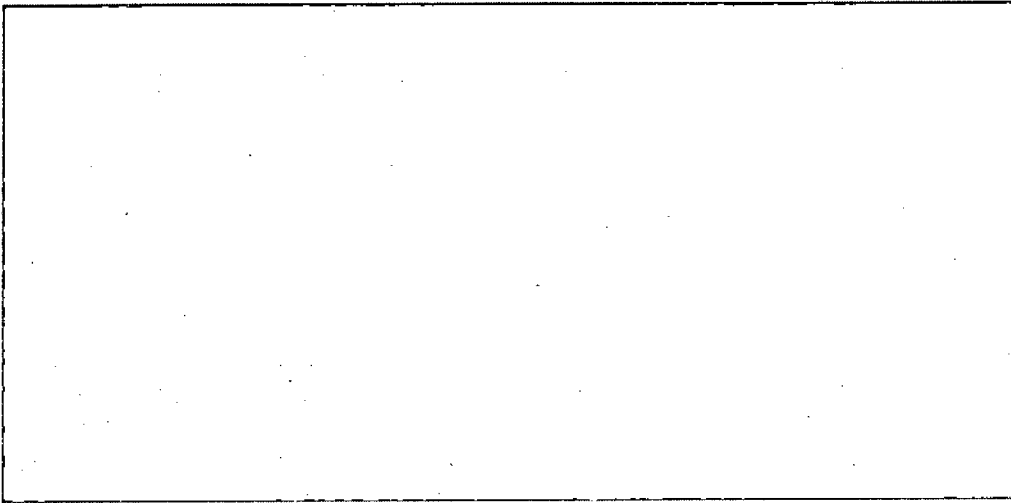

(RDX-9000C-31 (presented by Dr. Black during the 2018 Hearing)).

By contrast, when filtered port mirroring was applied, the “actions” in the [REDACTED]
[REDACTED] (Tr. (Black) at 329:18-330:4 (“Q. ... We're doing filtered port mirroring,
and we're applying [REDACTED]
[REDACTED].”), 325:17-21, 328:24-
330:10; JX-9020 at 742; Tr. (Almeroth) at 124:1-125:20 (2018 Hearing)).

Figure 21: Arista's Depiction of Test Output Applying Filtered Port Mirroring's
[REDACTED] ACLs

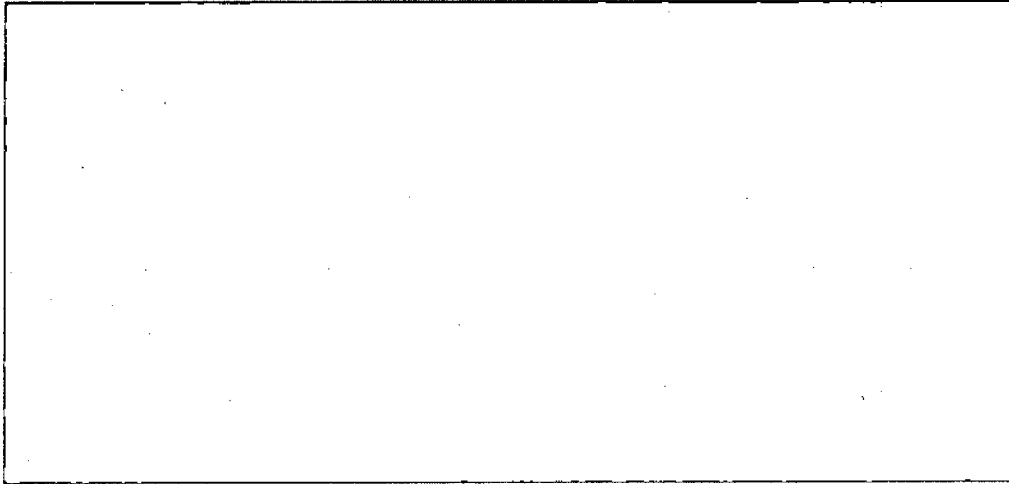

(RDX-9000C-32 (presented by Dr. Black during the 2018 Hearing)).

Contrasting these test outputs for [REDACTED] ACL” functionality and filtered port mirroring reinforces a critical operational nuance that bolsters Arista’s non-infringement argument for filtered port mirroring. Unlike [REDACTED] ACL” functionality, filtered port mirroring [REDACTED] packets. (Tr. (Black) at 303:16-304:3, 304:9-305:12; RX-9001C (Sweeney Witness Statement) at Q/A 306-12.). Instead it merely [REDACTED] packets that [REDACTED]. (*Id.*).

B. Infringement Overview

The asserted claims of the '577 patent are method claims. A finding of infringement against Arista requires an evidentiary showing of direct infringement by a third-party followed by indirect infringement by Arista. *Minnesota Mining & Mfg. Co. v. Chemque, Inc.*, 303 F.3d 1294, 1304-05 (Fed. Cir. 2002) (A patentee asserting a claim of induced infringement must show (i) that there has been direct infringement and (ii) that the alleged infringer “knowingly induced

infringement and possessed specific intent to encourage another's infringement.""); *Spanston, Inc. v. International Trade Comm'n*, 629 F.3d 1331, 1353 (Fed. Cir. 2010) ("to prevail on contributory infringement in a Section 337 case, the complainant must show inter alia: (1) there is an act of direct infringement in violation of Section 337; (2) the accused device has no substantial non-infringing uses; and (3) the accused infringer imported, sold for importation, or sold after importation within the United States, the accused components that contributed to another's direct infringement.").

1. Cisco Cannot Indiscriminately Import Evidence of Infringement of the '577 Patent from the Underlying Investigation

Cisco sought to import findings from the Underlying Investigation into this Modification Proceeding 2 under the banner of convenience. (CBr. at 47.). Cisco's basis for doing so was its consistent treatment throughout this Modification Proceeding 2 of [REDACTED] [REDACTED] ACL" functionality and filtered port mirroring functionality as members of the same class of [REDACTED] ACL" functionality found to infringe in the Underlying Investigation.

Having committed to this tack, Cisco asserted, with respect to alleged infringement by the Redesigned Switches, that this Modification Proceeding 2 should address *only* whether Arista's infringing [REDACTED] ACL" functionality has been removed. (*Id.* at 47 ("Having proved all of the elements of its case in the underlying proceeding, the focus of this action has been Arista's incorrect argument (to CBP and to the Federal Circuit) that the [REDACTED] [REDACTED] ACL functionality was "removed. ... Cisco need not re-prove every element of a violation of Section 337 by Arista. Arista's past inducement, coupled with [REDACTED]

[REDACTED] these features, is sufficient to demonstrate that the purportedly redesigned products are covered by the Commission's remedial orders.").

Yet Cisco's requested wholesale adoption here of infringement findings in the Underlying Investigation is not appropriate. While judicial economy counsels against re-litigation of settled issues; importing findings from the Underlying Investigation in a manner that is fair to Arista requires a showing that the issue that led to the finding was specifically litigated in the Underlying Investigation. Similarly, a finding would be required that nothing had materially changed regarding that finding since the Underlying Investigation, such that a new analysis would be duplicative of previous efforts.

Applying these criteria, it seems appropriate to import some findings from the Underlying Investigation. Specifically, it is appropriate to import that [REDACTED] [REDACTED] ACL" functionality satisfies the limitations of the asserted claims of the '577 patent. That functionality was found to satisfy the '577 claims in the Underlying Investigation. The [REDACTED] ACL" functionality was purportedly [REDACTED] in the Redesigned Switches but it was not [REDACTED] in the Redesigned Switches.

However, evidence of direct and indirect infringement of the '577 patent with respect to Redesigned Switches (e.g., intent, third-party use) will not be imported from the Underlying Investigation. That is because most of the relevant evidence on these issues arose after the evidentiary record closed in the Underlying Investigation.

Similarly, Cisco cannot show that filtered port mirroring infringes here by importing evidence from the Underlying Investigation pertaining to categorical infringement by a [REDACTED]

[REDACTED] ACLs.” This is because infringement by filtered port mirroring was not specifically accused or litigated in the Underlying Investigation. Cisco has not demonstrated that filtered port mirroring falls squarely within the infringing class of [REDACTED] ACL” functionality. Indeed, it is a finding of this decision that the opposite is true.

2. [REDACTED] ACL” Functionality Does Not Infringe the ’577 Patent

Arista did not dispute that [REDACTED] ACLs” functionality was found to infringe in the Underlying Investigation. Arista did not rebut Cisco’s evidence that Dr. Almeroth used infringing [REDACTED] ACLs” on a Redesigned Switch. (Tr. (Almeroth) at 112:25-117:22; CDX-9003C-20–23; Tr. (Black) at 332:18-333:19, 332:1-24 (“Q. ... Dr. Almeroth was able to [REDACTED] on a redesigned switch with Arista redesigned software, correct? A. He alleges that he did. That's all I said and all I know for sure.”), 333:11-13 (“Q. You never examined an Arista switch after Dr. Almeroth's [REDACTED], correct? A. I have not.”). What Arista does dispute is whether Arista’s customers [REDACTED] [REDACTED] as Dr. Almeroth did when he tested Arista’s Redesigned Switches for infringing functionality and whether Arista helped them do so.

a) Arista’s Failure to Produce Customer Communications Does Not Give Rise to an Inference That Third-Parties Use [REDACTED] [REDACTED]” in Redesigned Switches

Cisco asserted that Arista is precluded from arguing that there is no evidence of customer use of [REDACTED] ACLs” functionality in Redesigned Switches. Additionally, Cisco also argued that an “adverse inference of customer use should be entered.” (CBr. at 39; CRBr. at 32.). According to Cisco, an adverse inference sanction is warranted

because Arista violated Order No. 12 before the Hearing by refusing to produce customer communications on the use of [redacted] ACL” functionality in Redesigned Switches.⁵² (CRBr. at 33 n.24.). After the hearing, Arista purportedly attempted to produce such communications.⁵³ (*Id.*).

Cisco’s expert Dr. Almeroth [redacted]
[redacted] functionality in a Redesigned Switch in a way found to infringe in the Underlying Investigation.⁵⁴ (Tr. (Almeroth) at 13:10-117:22 (2018 Hearing)). Arista

⁵² Arista disputed both that it engaged in discovery behavior that violated a court order and asserted that “there is no actual dispute about how the [redacted] mechanism works.” (RRBr. at 39-40.). Specifically, Arista contended that it produced all the source code for the [redacted]—both in its original and hardened form. (*Id.* at 38-39 (citing 12/5/2017 B. Lewis Email to C. Murray (regarding production of both sets of [redacted] code); 12/5/2017 M. Woodhouse to Email to Kirkland & Ellis LLP (regarding date of production of hardened [redacted]); CPX-9048C ([redacted]); CPX-9047C ([redacted]))).

Arista did violate Order No. 12 as it was informed during the Hearing. (Tr. at 26:11-27:2; *see also* Dec. 8, 2017 Telephonic Hearing Tr. at 18-20 (“Dec. 8, 2017 Tel. Tr.”) (Doc. ID No. 631471 (Dec. 8, 2017))).

Arista also contended that it produced six (6) exemplary Redesigned Switches with an [redacted] (two during the Customs proceeding and four in the modification proceeding). (RRBr. at 39 (citing CPX-9001C)). In addition, at Cisco’s request, Arista created and produced an exemplary [redacted] output from an exemplary switch. (*Id.* (citing RX-9337C (prefdl.txt)). Similarly, Arista purportedly produced hundreds of “[redacted]” for Redesigned Switches showing an [redacted] [redacted]. (*Id.* (citing 12/5/2017 M. Woodhouse Email to Kirkland & Ellis LLP)).

⁵³ Cisco asserted that, after the Hearing, Arista sent two (2) letters to Cisco concerning Arista’s attempt to produce a set of documents allegedly concerning customer communications. (CRBr., Exs. A-B (1/30/18 and 2/8/18 Ltrs. from J. Homrig to A. Alper)).

⁵⁴ Cisco points to [redacted] continued use of [redacted] ACLs. (Tr. (Almeroth) at 129:23-130:20; JX-9023C (Maltz Decl.) at 2-3, 6; CPX-9125C; CPX-9110C.). However, it is undisputed that [redacted] does so [redacted]. (JX-9023C (Maltz Decl.) at 7 (explaining that [redacted] does not [redacted] [redacted])). While [redacted] use of [redacted] ACLs is a testament to the importance of the

PUBLIC VERSION

characterized as a “[redacted]” this use of “[redacted] ACLs” functionality by Dr. Almeroth. (RBr. 1, 34-36.). Cisco then argued in the abstract that “there is no denying that Dr. Almeroth’s [redacted] [redacted]—could be communicated by Arista to its customers, who could then easily [redacted]” (CRBr. at 32 (citing Tr. (Almeroth) at 115:12-21 (2018 Hearing))).

Yet the evidence does not comport with Cisco’s hypothetical with respect to customer use of [redacted] ACLs” functionality. Far from being an ordinary customer, as an expert in this Modification Proceeding 2 with access to Arista’s highly confidential internal documents and source code, Dr. Almeroth was in a unique position to effectuate the “[redacted].” (Tr. (Almeroth) at 183:3-22 (2018 Hearing) (“I can’t unlearn the details of what I’ve learned through this case.”)). Moreover, Cisco’s assertion that Dr. Almeroth’s “[redacted]” was based on “publicly-accessible files and publicly-available user instructions from Arista” rings hollow given the dearth of evidence of similar behavior by Arista’s customers “possess[ing] a high level of technological sophistication,” who Cisco could have subpoenaed for testimony and documents.⁵⁵ (CBr. at 48 (citing Tr. (Almeroth) at 114:17-23, 116:1-117:8; JX-9017 (Arista Parser 101) at 1).).

functionality, it is not a basis for direct infringement of the ’577 patent in this Modification Proceeding 2.

⁵⁵ There was a discovery dispute over the production of documents in Arista’s possession, custody or control containing communications that Arista provided to customers after it redesigned its switches. (See Dec. 8, 2017 Telephonic Hearing Tr. at 18-20 (Doc. ID No. 631471 (Dec. 8, 2017) (Mr. Lumish, Counsel for Arista: “The documents we’re producing, as I mentioned before, will be over-inclusive in that

PUBLIC VERSION

Nevertheless, Arista fell short of its discovery obligation to produce customer communications with respect to [REDACTED] ACLs” functionality. (See Order No. 12 at 11; *see also* Dec. 8, 2017 Tel. Tr. at 18-20). Arista decided to “[REDACTED]” and not remove infringing [REDACTED] ACLs” functionality, exposing Cisco’s patent-protected technology to [REDACTED] (as demonstrated by Dr. Almeroth). Arista then advanced self-serving testimony from fact and expert witnesses⁵⁶ with respect to the operation of Redesigned Switches while, at the same time, withholding from Cisco its customer communications concerning the same.

As Order No. 12 recognizes, “[c]learly, Arista must have some documentation with respect to those [REDACTED] switches that identifies which of Arista’s customers received which switches, how those switches are coded (i.e. source code) and instructions Arista gives for using its allegedly redesigned switches. Documents of that type Arista was obligated to produce.” (Order No. 12 at 11.). Arista’s assertion that any such communications do not exist simply does not pass muster (as demonstrated by Arista’s attempt to produce what may have been customer communications after the Hearing which should have been produced before the Hearing.).

we don’t have time or the ability to go through and make sure they are all actually customer communications and the like. It will be at least that, and then much more.”). Yet, Arista never provided a complete set of these documents to Cisco.

⁵⁶ Dr. Black and Mr. Sweeney each testified about the operation of the [REDACTED] mechanism. (Tr. (Black) at 290:14-293:14; RDX9000C-11, 12; RX-9001C (Sweeney Witness Statement) at Q/A 364-66. Arista also introduced un rebutted testimony from Mr. Sweeney that Arista’s Redesigned Switches possess [REDACTED] hardware. (RX-9001C (Sweeney Witness Statement) at Q/A 365.).

PUBLIC VERSION

Arista is now precluded from arguing that there is no evidence of direct infringement of the '577 patent based on [REDACTED] ACL" functionality in Redesigned Switches. Moreover, Arista's behavior has given rise to an adverse inference that it communicates with its customers regarding ways to use [REDACTED] ACL" functionality in switches running any version of EOS other than the redesigned versions. *See, e.g., Certain Video Graphics Display Controllers*, Inv. No. 337-TA-412, Order No. 47, *at 5-6 (U.S.I.T.C. Jan. 14, 1999) (failure to comply with discovery orders and an "extremely late production of a large volume of responsive documents" on the eve of trial resulted in "the entry of a rebuttable adverse factual inference.").

The chart of legacy and Redesigned Switches (hardware/software combinations) attached as Appendix C to Arista's Post-Hearing Reply Brief, and the availability on Arista's website of earlier versions of [REDACTED], are evidence that Arista is keenly aware of whether, and the conditions under which, its switches can support [REDACTED] ACL" functionality, as well as the importance of giving customers opportunities to do so. (RRBr., App. C; Tr. (Almeroth) at 118:4-16 (2018 Hearing); JX-9020 at 375; CX-9141C at 1-18.).

However, a broader adverse inference that Cisco asked be applied to Arista's Redesigned Switches is not appropriate because Arista has presented evidence that its Redesigned Switches [REDACTED] ACL" functionality. Specifically, Arista presented undisputed evidence that Dr. Almeroth's "[REDACTED]" is [REDACTED] in Redesigned EOS versions [REDACTED]. (Tr. (Black) at 333:2-17; RX-9001C (Sweeney Witness Statement) at Q/A 344-47.).

Arista has also presented undisputed evidence that Dr. Almeroth's "[redacted]" is not possible in Hardened Redesigned EOS versions [redacted]. (RBr. at App. C.).

b) Cisco Has Not Proven That "[redacted] ACLs" Functionality Infringes

Cisco had the burden of proving by a preponderance of the evidence that Arista's customers have used [redacted] ACL" functionality within Redesigned Switches. This Cisco has not done. Cisco's primary example of Arista's customers' purported use of [redacted] ACL" functionality occurred in [redacted] switches operated by [redacted]. Those switches are not at issue in this Modification Proceeding 2. (CBr. at 39; RRB. at 2, 34 (citing Tr. (Black) at 298:19-299:25; RX-9019C; RX-9020C; RX-9021C).). As discussed in the claim-by-claim analysis below, Cisco has not proffered evidence of direct infringement of the asserted '577 patent claims by Arista's customers using Redesigned Switches. Consequently, with respect to [redacted] ACL" functionality, Arista's Redesigned Switches do not infringe the asserted claims of the '577 patent.

3. Filtered Port Mirroring Does Not Infringe the '577 Patent

Cisco asserted that filtered port mirror functionality infringes 5 claims of the '577 patent.⁵⁷ Those claims contain numerous limitations, whose construction and alleged presence in

⁵⁷ Before the Hearing in this Modification Proceeding 2, Arista filed a motion *in limine* to preclude evidence of infringement by filtered port mirroring because that functionality was not specifically accused in the Underlying Investigation. (Motion Docket No. 945-060 (Jan. 5, 2018)). Arista's motion was denied because Cisco's Opposition raised a legitimate fact issue over whether filtered port mirroring in Redesigned Switches was identical in operation to filtered port mirror in legacy switches which needed to

the Redesigned Switches could, in theory, give rise to numerous disagreements among the Parties. Yet, rather than sparring at a granular level, Arista rests its non-infringement case on a global argument that filtered port mirroring does not practice “access control,” as that term is used in the asserted claims of the ’577 patent.⁵⁸ For the reasons set forth below, Arista is correct.

a) “Access Control” Restricts Packet Transmission

The scope of the term “access control” is an appropriate place to start. In the Underlying Investigation, the Parties agreed that “access control” should possess its plain and ordinary meaning. (*Markman* Order at 12; ID at 129.). The ’577 patent addresses “access control” from the outset, using quotations to define the term: “In a computer network for transmitting information, *messages can be restricted from being transmitted from selected source devices to selected destination devices*. In known computer networks, this form of restriction is known as ‘access control’ and is performed by routers, which route messages (in the form of individual packets of information) from source devices to destination devices.” (JX-9002 (’577 patent) at 1:4-10 (emphasis added). Cisco’s expert, Dr. Almeroth, cited to these lines of the ’577 patent to explain how the patent uses the term “access control.” (Tr. (Almeroth) at 168:8-20 (2018 Hearing)).

be explored. (Opp’n at 5-10 (Doc. ID No. 633702 (Jan. 12, 2018); *see also* Order No. 11 at 10 (Doc. ID No. 634262 (Jan. 19, 2018)).

⁵⁸ The “access control” claim limitation appears explicitly or implicitly in several claim limitation at issue, including “perform access control processing,” “set of access control patterns,” and “generating an access result.” (JX-9002 (’577 patent) at 7:34-47.).

PUBLIC VERSION

The ID in the Underlying Investigation discusses “access control.” In a section pertaining to anticipation of the ’577 patent by a prior art patent known as Feldmeier,⁵⁹ the ID states that “‘access control’ in claim 1 certainly includes and may be even broader than filtering packets such that some are permitted and some are discarded. (*Compare* JX-0005 claim 1 (“making a routing decision in response to said access result”) *with* claim 15 (“said routing decision includes permitting or denying access”).)” (ID at 131-32.).⁶⁰ Yet, even Dr. Almeroth suggested that “access control” requires some semblance of packet policing or control over packet movement. (Tr. in ’945 (I) (Almeroth) at 2969:5-9.). He testified in the Underlying Investigation about Feldmeier, that mere packet forwarding is “very different” from the claimed “access control.” (*Id.*). Tellingly, in the Underlying Investigation, packet transmission were the only functions Dr. Almeroth and Staff identified as satisfying the “access control” limitation in Arista’s accused products. (ID at 132.).

While “access control” in claim 1 “may be even broader than filtering packets such that some are permitted and some are discarded,” the critical issue is whether “access control” is broad *enough* to cover filtered port mirroring. Arista denied this. However, in support of its non-infringement position, Arista tried to read limitations into the claims. Arista argued, for example, that “access control” required “checking the source address and/or destination address of the packet against access control rules that determine whether that source is permitted to send

⁵⁹ U.S. Patent No. 5,920,886 (“Feldmeier”) is entitled “Accelerated Hierarchical Address Filtering and Translation Using Binary and Ternary CAMs.” (ID at 128.).

⁶⁰ For example, claim 14 requires that “said routing decision includes implementing a quality of service policy.” (JX-9002 (’577 patent) at 8:25-26.).

PUBLIC VERSION

packets to that destination,” which port mirroring does not do. (RBr. at 41 (citing Tr. (Black) at 302:14-303:15; RDX-9000C-28).). While this argument appears to present a valid distinction between typical use cases of “access control” and filtered port mirroring, the asserted independent claims (and several of the asserted dependent claims) do not contain the limitation. (JX-9002 ('577 patent) at 7:35-8:28.).

The ID and the Commission Opinion in the Underlying Investigation each make clear that switches practicing “access control” can, but need not, use specific sender or recipient identifiers. (ID at 20 (“a computer network *may implement access control* by restricting the transmission of information from a certain sender to a certain destination”) (emphasis added); Commission Op. (FD) at 22 (“a computer network *may implement access control* by restricting the transmission of information from specified source devices to specified destination devices. ... One technique for implementing access control involves reference to one or more ACLs, which describe whether the transmission of information is permitted or prohibited from a certain sender (or range of senders) to a certain destination (or range of destinations).”) (emphasis added)).

Under the doctrine of claim differentiation, claim 1 is broad enough to cover “access control” without using “a source IP address or subnet, a destination IP address or subnet, a source port, a destination port, a protocol specifier, or an input interface.” (*Compare* JX-9002 ('577 patent) at 7:34-48 (claim 1) *with id.* at 8:6-10 (dependent claim 8)). Indeed, Dr. Black, one of Arista’s technical experts, conceded that “access control” rules require neither a source nor a destination for a packet. (Tr. (Black) at 331:6-11 (“The access control rules don't need to specify both [a source and a destination] or either”).).

b) Filtered Port Mirroring Does Not Practice “Access Control”

Faced with a newfound uncertainty over the meaning of “access control,” Cisco highlighted operational similarities between port mirroring and [REDACTED] ACL” functionality found to infringe in the Underlying Investigation. It is undisputed that port mirroring ACLs are configured by the same “access list” command that was identified in the Underlying Investigation to generate the infringing [REDACTED] ACLs.” (JX-9020 at 742, 989; Tr. (Almeroth) at 122:1-16 (2018 Hearing); CX-9172C at 41.). Port mirroring uses another component of the infringing [REDACTED] ACL” functionality from the Underlying Investigation: [REDACTED] to access control patterns in [REDACTED]. (Tr. (Almeroth) at 122:23- 123:8 (2018 Hearing); CX-9100C at 870; CX-9201C 109:1-9.). It is also true that filtered port mirroring exhibits a vague resemblance to [REDACTED] ACL” functionality, insofar as the former determines whether a packet is mirrored and, when it is, implicitly grants access of the packet copy to the mirrored destination port. (Tr. (Almeroth) at 124:1-24, 190:11-24 (2018 Hearing); Tr. (Black) at 328:16-329:6, 329:18-330:10.).

Yet the scope of the invention is defined by the claims considering the specification,⁶¹ not by products currently accused of infringement or previously adjudged to infringe. The ’577 patent specification provides a clear articulation of the plain and ordinary meaning of “access control” performed by routers: “messages [in the form of individual packets of information] can

⁶¹ In cases where the meaning of a disputed claim term in the context of the patent's claims remains uncertain, the specification is the “single best guide to the meaning of a disputed term.” *Phillips*, 415 F.3d at 1321. Moreover, “[t]he construction that stays true to the claim language and most naturally aligns with the patent's description of the invention will be, in the end, the correct construction.” *Id.* at 1316. As a general rule, however, the particular examples or embodiments discussed in the specification are not to be read into the claims as limitations. *Id.* at 1323.

be *restricted from being transmitted* from selected source devices to selected destination devices.” (JX-9002 (’577 patent) at 4-8.). Inherent in the notion of transmission is movement of a thing (in this case, a packet) from a source and to a destination. (*Id.* at 1:4 (“[i]n a computer network for transmitting information ...”).) A packet leaves and, sometime later, the packet arrives. (*Id.* at 1:4-8.) Along the way, its transmission can be restricted. (*Id.*)

Cisco argued that Arista cannot distinguish filtered port mirroring from “access control” given the breadth of the asserted claims of the ’577 patent. During the Hearing, Dr. Almeroth conceded that filtered port mirroring operates as Arista described but nevertheless opined that the asserted claims of the ’577 patent were broad enough to cover filtered port mirroring. (Tr. (Almeroth) at 192:8-12 (“Q: The port mirroring [redacted] never [redacted] [redacted]. Isn't that true, Doctor? A: That's correct. It doesn't have to to meet the claim.”)). According to Cisco, claim 1 of the ’577 patent simply requires a packet—not an “original” or “copy.” (JX-9002 (’577 patent) at 7:34-48.).⁶²

Yet, the weight of the intrinsic evidence suggests that “access control,” the salient claim limitation, is fundamentally different from filtered port mirroring. Nowhere does the ’577 patent associate “access control” of a packet with restricting the [redacted], as opposed to restricting the transmission of a packet. (*See, generally*, JX-9002 (’577 patent)). The ’557 patent is silent on using ACLs to [redacted] a packet. (*Id.*) Similarly, the ’577 patent is silent on using ACLs to create [redacted], such that [redacted]

⁶² “[T]he asserted ’577 claims are not limited to performing access control only on the ‘original’ version of the packet to the exclusion of a copy of that same packet ... Nor does the specification distinguish between the ‘original’ packet and copy of that packet.” (CRBr. at 41.).

[REDACTED]

[REDACTED], as is the case with port mirroring. (*Id.*).

The weight of the evidence, as explained by Dr. Black and tacitly acknowledged by Dr. Almeroth, is that persons of ordinary skill in the art view filtered port mirroring as fundamentally different from “access control.”⁶³ (Tr. (Black) at 303:16-304:8.). “[F]iltered port mirroring never [REDACTED] as required by the claims” and never [REDACTED] [REDACTED].” (RBr. at 42-43 (citing Tr. (Black) at 305:13-24, 308:20-309:11).). Filtered port mirroring does not, and cannot, determine whether the sender of the original packet is permitted to send that packet to its destination. (Tr. (Almeroth) at 192:8-23 (2018 Hearing); Tr. (Black) at 303:16-304:3, 304:9-305:12; (RX-9001C (Sweeney Witness Statement) at Q/A 306-12).). “[REDACTED] [REDACTED] That is not access control.” (RX-9001C (Sweeney Witness Statement) at Q/A 240.).

Dr. Almeroth’s, Dr. Sweeney’s and Dr. Black’s explanations of filtered port mirroring is consistent with evidence that, notwithstanding the appearance of “access control” in the term “access control-lists,” such lists (abbreviated as ACLs) perform more than just traditional “access control.” (RDX-9000C-8 (Cisco materials distinguishing between the use of the term ACL and access control)). For example, Dr. David Maltz of [REDACTED] distinguished between two (2) kinds of ACLs—those used for access control, which he calls “source-destination permit-deny

⁶³ If the intrinsic evidence is insufficient to establish the clear meaning of a claim, a court may resort to an examination of the extrinsic evidence. *Zodiac Pool Care, Inc. v. Hoffinger Industries, Inc.*, 206 F.3d 1408, 1414 (Fed. Cir. 2000).

ACLs” and those used merely to select packets for other features “packet classification ACLs.” (JX-9023C (Maltz Decl.) at 2.). Dr. Maltz described filtered port mirroring as [REDACTED] [REDACTED]” and not a [REDACTED] ACL. (*Id.* at 10.). As Dr. Black testified, filtered port mirroring functionality could be designed to create copies of original packets and subsequently use ACLs to restrict the transmission of those packets to a mirrored designation port. (Tr. (Black) at 329:13-17.). That would entail transmission restriction as taught by the ’577 patent. That is not how filtered port mirroring works in the Redesigned Switches. (*Id.*)

In filtered port mirroring, the “[REDACTED],” the one described in the ’577 patent’s specification, proceeds [REDACTED] by the filtered port mirroring ACL. (Tr. (Black) at 305:13-24, 308:20-309:11.). This prompted Cisco to adopt Arista’s “[REDACTED]” label, asserting that port mirroring ACLs “operate on the [REDACTED]’ packet—i.e., the one that would be [REDACTED] [REDACTED].” (Tr. (Almeroth) at 124:1-24, 190:11-24 (2018 Hearing).). The wordsmithing of this line is important.

By using the word “would,” Cisco admitted that the [REDACTED] does not exist and thus never engaged in an act of transmission that can be restricted. Cisco needed to use this phrasing because filtered port mirroring ACLs do not operate on the [REDACTED] of a packet. (Tr. (Black) at 305:13-24.). Instead, they operate on the [REDACTED] and, once the

[REDACTED], it is free to [REDACTED]

[REDACTED].⁶⁴ (*Id.* at 303:20-306:17, 329:13-17.).

In light of the above, filtered port mirroring does not infringe the asserted claims of the '577 patent. Specifically, the filtered port mirroring functionality in the Redesigned Switches does not practice "access control" as required by each of the asserted claims. This is because the functionality uses ACLs to restrict [REDACTED] of packets, not to restrict [REDACTED]. The analysis stops there because Cisco did not raise a DOE argument for these claims.

In sum, as discussed in greater detail below, the Redesigned Switches do not infringe claims 1, 7, 9-10, and 15 of the '577 patent. There is no evidence of direct infringement by customers using [REDACTED] ACL" functionality that Dr. Almeroth found accessible in certain Redesigned Switches. Moreover, filtered port mirroring functionality in the Redesigned Switches does not practice "access control" as required by each of the asserted claims.

That said, the claim-by-claim analysis that follows considers Cisco's evidence for each limitation of the asserted claims of the '577 patent to create a complete record in the event that the Commission finds that Cisco has proffered evidence of direct infringement using [REDACTED] [REDACTED] ACL" functionality or that "access control" covers filtered port mirroring.

⁶⁴ It is important to note that, before the [REDACTED], it was not possible to control its access to anything.

C. Claim-by-Claim Analysis Reveals That the '577 Patent Covers [redacted] [redacted] ACL" Functionality But Does Not Cover Filtered Port Mirroring Functionality

As an initial matter, Arista did not dispute that [redacted] ACL" functionality that Dr. Almeroth found to be [redacted] satisfies each of the limitations found in the asserted claims of the '577 patent, just as [redacted] [redacted] ACL" functionality did in the Underlying Investigation. However, Arista disputed that filtered port mirroring functionality satisfies the asserted claims of the '577 patent.

1. Independent Claim 1 of the '577 Patent Does Not Cover Filtered Port Mirroring Functionality in Redesigned Switches

Figure 22: Cisco's Depiction of Limitations in Claim 1 of the '577 patent

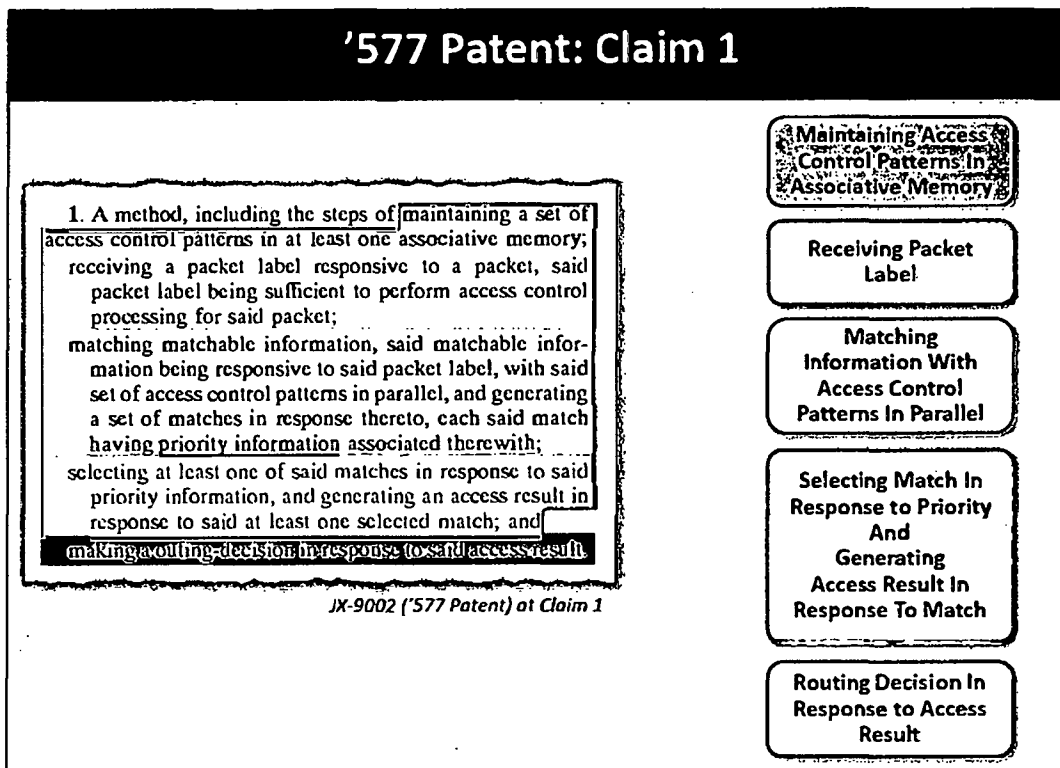

(CDX 9003C 41 (presented by Dr. Almeroth during the 2018 Hearing)).

Filtered port mirroring was not specifically accused by Cisco in the Underlying Investigation. (Cisco's Pre-Hearing Statement (Underlying Investigation) (Doc. ID No. 566848 (Oct. 7, 2015))). Arista does not dispute that filtered port mirroring functionality found in Redesigned Switches infringes claim 1 of the '577 patent, assuming that such functionality performs "access control." (RBr. at 41-44.). Yet, because Cisco's evidentiary showing in the Underlying Investigation was not specifically drawn to filtered port mirroring, a claim-by-claim infringement analysis of filtered port mirroring is warranted here.

i. Step 1: "A method, including the steps of maintaining a set of access control patterns in at least one associative memory"

Absent "access control," Cisco has met its burden of proving by a preponderance of the evidence that the Redesigned Switches satisfy the "maintain a set of access control patterns" limitation. Filtered port mirroring ACLs are created through the same "access list" command described in the Underlying Investigation as the genesis of the infringing [] ACLs. (Tr. (Almeroth) at 123:9-25, 126:7-21 (2018 Hearing); JX-9024C at 7; CX-9201C at 109:1-9.). Filtered port mirroring ACLs [] as the products found to infringe the '577 patent in Underlying Investigation. (*Id.*).

ii. Step 2: "receiving a packet label responsive to a packet, said packet label being sufficient to perform access control processing for said packet"

Absent "access control," Cisco has met its burden of proving by a preponderance of the evidence that the Redesigned Switches satisfy the "receiving a packet label" limitation. Arista's Redesigned Switches receive a packet label, responsive to a packet, that is sufficient to perform access control processing for said packets. (CX-9009C at 14; CX-9027 at 8-9; Tr. (Almeroth) at 126:22-127:10 (2018 Hearing); JX-9024C at 3; CX-9130C at 1.).

- iii. Step 3: “matching matchable information, said matchable information being responsive to said packet label, With said set of access control patterns in parallel, and generating a set of matches in response thereto, each said match having priority information associated therewith”**

Absent “access control,” Cisco has met its burden of proving by a preponderance of the evidence that the Redesigned Switches satisfy the “matching ... in parallel” limitation. Arista’s Redesigned Switches match matchable information, responsive to the packet label, with said set of access control patterns in parallel. (CX-9097C at 323; CX-9139C at 689; Tr. (Almeroth) at 127:11-17 (2018 Hearing); JX-9024C at 3; JX-9021C at 407.).

- iv. Step 4: “selecting at least one of said matches in response to said priority information, and generating an access result in response to said at least one selected match”**

Absent “access result,” Cisco has met its burden of proving by a preponderance of the evidence that the Redesigned Switches satisfy the “selecting ... and generating an access result” limitation. Arista’s Redesigned Switches select at least one of the matches in response to the priority information. (CX-9010C at 17, 22; Tr. (Almeroth) at 127:18-128:3 (2018 Hearing); JX-9024C at 3; JX-9019C at 40.). Moreover, Arista’s redesigned products also generate a result in response to the at least one selected match. (CX-9009C at 9; CX-9189C at 71:13-17; Tr. (Almeroth) at 128:4-14 (2018 Hearing); JX-9020 at 742; JX-9024C at 3.).

- v. Step 5: “making a routing-decision in response to said access result”⁶⁵**

⁶⁵ See Certificate of Correction, dated 8/12/03 (correcting misspelling of “outing-decision” to routing decision). (*Markman* Order at 8.).

Absent “access result,” Cisco has not met its burden of proving by a preponderance of the evidence that the Redesigned Switches satisfy the “making a routing decision” limitation.

Arista’s Redesigned Switches make a decision in response to said result. (CX-9027 at 8; CX-9009C at 8; CX-9189C at 93:15-18; Tr. (Almeroth) at 128:15-129:1 (2018 Hearing); JX-9020 at 742; JX-9024C at 3.). However, the decision is whether to [redacted] of a packet, not a decision regarding the [redacted] packet.

2. Dependent Claims 7, 9-10, and 15 of the ’577 Patent Do Not Cover Filtered Port Mirroring Functionality in Redesigned Switches

Absent “access control” and “access result,” Cisco has met its burden of proving by a preponderance of the evidence that the Redesigned Switches satisfy claims 7 and 9-10.

This was not a forgone conclusion because the only evidence that Cisco cited regarding infringement of these claims by the Redesigned Switches amounts to a mere 15 lines of hearing testimony from Dr. Almeroth in this Modification Proceeding 2. (Tr. (Almeroth) at 129:2-17 (2018 Hearing)). In the testimony, Dr. Almeroth referenced “evidence I already presented about the hardware and the chips ...,” without specifying when he presented the evidence. (*Id.*). According to Arista, this showing fails “to properly analyze or to provide evidence and testimony regarding the additional limitations of claims 9, 10, and 15.” (RBr. at 44 (citing *Dynacore Holdings Corp. v. U.S. Philips Corp.*, 363 F.3d 1263, 1278 (Fed. Cir. 2004) (“It is well settled that an expert's unsupported conclusion on the ultimate issue of infringement is insufficient to raise a genuine issue of material fact, and that a party may not avoid that rule simply by framing the expert's conclusion as an assertion that a particular critical claim limitation is found in the accused device.”)).

PUBLIC VERSION

In response, Cisco retreated to the Underlying Investigation. In that Investigation, Arista's legacy switches were found to meet the additional limitations of these dependent claims. (ID at 99.). Cisco contends that claims 7, 9, and 10 are directed to the operation of associative memory and that the associative memory at issue here—[redacted] in the Redesigned Switches. These are unchanged from those found to infringe in the Underlying Investigation. (CRBr. at 46 (citing JX-9002 ('577 patent); Tr. (Almeroth) at 129:2-17 (2018 Hearing)).

Although the evidence cited by Cisco does not support its claim that the [redacted] in the Redesigned Switches remain "unchanged," it has offered evidence in this Modification Proceeding 2 that filtered port mirroring functionality uses the same infringing "parallel matching to access control patterns in [redacted]" as was found to infringe in the '577 patent in the Underlying Investigation. (Tr. (Almeroth) at 119:21-125:20 (2018 Hearing); CX-9100C at 870; CX-9201C 109:1-9.). Thus, Cisco has provided sufficient proof from the Underlying Investigation that the Redesigned Switches satisfy the additional limitation set forth in dependent claims 7 and 9-10.

Cisco has not provided sufficient proof that the Redesigned Switches satisfy the additional limitation set forth in dependent claim 15 that "said routing decision includes permitting or denying access for said packet." (JX-9002 ('577 patent) at 8:27-28.). For reasons stated above in the discussion of the meanings of "access control" and "access result," the port mirroring functionality in Arista's Redesigned Switches does not [redacted] packets from a sender to a destination. (Tr. (Black) at 311:22-312:8.). Instead, they [redacted] because the filtered port mirroring ACLs [redacted] [redacted]. (*Id.*).

Thus, but for absence of claim terms "access control" and "access result," Cisco has

proven by a preponderance of the evidence that the Redesigned Switches infringe dependent claims 7 and 9-10 of the '577 patent.

D. Redesigned Switches Do Not Infringe the '577 Patent

Cisco asserted that Arista indirectly infringes the '577 patent by inducing or contributing to the direct infringement by its customers. (CBr. at 46-50.). As discussed below, the weight of the evidence establishes that Arista does not indirectly infringe the '577 patent.⁶⁶

“Whoever actively induces infringement of a patent shall be liable as an infringer.” 35 U.S.C. § 271(b). A patentee asserting a claim of inducement must show (i) that there has been direct infringement and (ii) that the alleged infringer “knowingly induced infringement and’ possessed specific intent to encourage another’s infringement.” *Minnesota Mining & Mfg. Co. v. Chemque, Inc.*, 303 F.3d 1294, 1304-05 (Fed. Cir. 2002). With respect to the direct infringement requirement, the patentee “must either point to specific instances of direct infringement or show that the accused device necessarily infringes the patent in suit.” *ACCO Brands, Inc. v. ABA Locks Mfrs. Co., Ltd.*, 501 F.3d 1307, 1313 (Fed. Cir. 2007) (citation omitted). This requirement may be shown by circumstantial evidence. *Vita-Mix Corp. v. Basic Holding, Inc.*, 581 F.3d 1317, 1326 (Fed. Cir. 2009). “[A] finding of infringement can rest on as little as one instance of the claimed method being performed during the pertinent time period.” *Lucent Techs., Inc. v. Gateway, Inc.*, 580 F.3d 1301, 1317 (Fed. Cir. 2009).

⁶⁶ Since the Redesigned Switches do not directly infringe the '577 patent, there cannot be indirect infringement of the '577 patent. See *In re Bill of Lading Transmission & Processing Sys. Pat. Litig.*, 681 F.3d 1323, 1333 (Fed. Cir. 2012).

The Federal Circuit has held that “to prevail on contributory infringement in a Section 337 case, the complainant must show, *inter alia*, that: (1) there is an act of direct infringement in violation of Section 337; (2) the accused device has no substantial non-infringing uses; and (3) the accused infringer imported, sold for importation, or sold after importation within the United States, the accused components that contributed to another’s direct infringement.” *Spansion, Inc. v. International Trade Comm’n*, 629 F.3d 1331, 1353 (Fed. Cir. 2010). “[N]on-infringing uses are substantial when they are not unusual, far-fetched, illusory, impractical, occasional, aberrant, or experimental.” *Vita-Mix*, 581 F.3d at 1327. Section 271(c) also requires knowledge of the existence of the patent that is infringed. *Global-Tech Appliances, Inc. v. SEB S.A.*, 131 S.Ct. 2060, 2068 (2011).

1. Arista’s Customers Do Not Directly Infringe the ’577 Patent

There is no evidence that Arista’s customers used Redesigned Switches to directly infringe the ’577 patent. There is no evidence that any customer ever used [REDACTED] [REDACTED] ACLs” in Redesigned Switches, notwithstanding Dr. Almeroth’s “[REDACTED]” demonstrating the potential for such direct infringement. (Tr. (Black) at 297:20-299:25; (RX-9001C (Sweeney Witness Statement) at Q/A 340-45.).

However, Cisco has demonstrated that Arista’s customers use [REDACTED] ACLs with port mirroring on Arista’s Redesigned Switches. (Tr. (Almeroth) at 130:21-131:16 (2018 Hearing)). Arista does not dispute this use. (Tr. (Black) at 300:5-313:1.). For example, [REDACTED] ACLs with port mirroring. (JX-9023C at 9-10; CPX-9101 at line 1709; CX-9201C at 113:12-19; CX-9199C at 142:3-19.). Customer use of filtered port mirroring in Redesigned Switches is also shown by Arista’s limited production of customer support

communications. (Tr. (Almeroth) at 131:8-16 (2018 Hearing); CX-9120C at 1-4 ([REDACTED]); CX-9113C ([REDACTED]); CX-9119C ([REDACTED])).

Arista's customers would directly infringe the '577 patent if filtered port mirroring were found to practice "access control" and "access result." See *ePlus, Inc. v. Lawson Software, Inc.*, 700 F.3d 509, 520 (Fed. Cir. 2012) (method claims require actual performance of every step of the claim). As that is not the case here, Cisco has failed to prove by a preponderance of the evidence that Arista's customers have directly infringed the '577 patent using Redesigned Switches.

2. Arista Does Not Induce or Contribute to Its Customers' Direct Infringement of the '577 Patent

While Arista certainly had knowledge of the '577 patent, it is far from clear whether Arista has the requisite intent to indirectly infringe the '577 patent with Redesigned Switches.⁶⁷ For the reasons set forth below, Arista lacked the requisite intent to indirectly infringe the '577 patent with [REDACTED] ACL" functionality. For several reasons, there is evidence that Arista also lacked the requisite intent to indirectly infringe the '577 patent with port mirroring functionality.

⁶⁷ The ID in the Underlying Investigation found that Arista had knowledge of the '577 patent as of December 4, 2014. (ID at 108-109.). With respect to Arista's legacy switches, the ID and Commission Opinion in the Underlying Investigation found that Arista indirectly infringed the '577 patent both by inducing and contributing to the direct infringement of others with specific intent and knowledge of the '577 patent. (*Id.* at 107; Commission Op. (FD) at 30-31.).

PUBLIC VERSION

The weight of the evidence demonstrates that Arista appears to have made a sincere attempt to [redacted] ACL functionality found to infringe in the Underlying Investigation. According to its witnesses, Arista invested more than [redacted] person-hours (including its [redacted]) and \$ [redacted] to redesign its products, although it is unclear how much of this effort is attributable to [redacted] [redacted] ACLs” because Arista does not provide evidence regarding how it apportioned its redesign effort between the separate tasks of [redacted] [redacted] (RX-9001C (Sweeney Witness Statement) at Q/A 18, 241, 251; CX-9201C (Holbrook Dep.) at 24:2-5.).

Arista communicated changes in its Redesigned Switches to its customers. (RX-9001C (Sweeney Witness Statement) at Q/A 22-24, 241.). In the Redesigned Switches, [redacted] [redacted] ACL” functionality was not supported, although it [redacted] in the Redesigned EOS, as Dr. Almeroth demonstrated. (Tr. (Black) at 293:15-295:23.). When informed of Dr. Almeroth’s “[redacted],” Arista released a new version of EOS that [redacted] [redacted]. (Tr. (Black) at 297:9-19; RX-9001C (Sweeney Witness Statement) at Q/A 347). These actions are inconsistent with Cisco’s narrative that Arista was a company that knew of [redacted] [redacted] ACL” functionality in Redesigned Switches, in violation of the ’577 patent. *See Fujitsu Ltd. v. LG Elecs.*, 620 F.3d 1321, 1320 (Fed. Cir. 2010) (for contributory infringement, specific intent requires knowledge that the “acts constituted infringement”); *Commil USA, LLC v. Cisco Systems, Inc.*, 720 F.3d 1361, 1367 (Fed. Cir. 2013), *aff’d and vacated in part on other grounds*, 135 S.Ct. 1920, 1926-28 (2015) (specific intent requirement for inducement necessitates a showing that he knew that his actions would induce actual direct infringement.).

Moreover, Cisco failed to demonstrate that Arista possessed the requisite intent for indirect infringement with respect to the use of [REDACTED] ACL” functionality in Redesigned Switches. Cisco contended that Arista encouraged customers to [REDACTED] [REDACTED],” without specifying whether and to what extent this allegation pertains to the Redesigned Switches. (CBr. at 48 (citing Tr. (Almeroth) at 131:17-132:5; CX-9129 at 1; JX-9020 at 375).). Arista’s refusal to produce customer communications with respect to their use of [REDACTED] ACL” functionality does create an adverse inference that Arista communicates with its customers regarding ways to use [REDACTED] ACL” functionality. Yet, as explained above, this inference applies only to legacy switches. The lack of evidence that Arista’s customers used [REDACTED] ACL” functionality in Redesigned Switches belies Cisco’s suggestion that “Arista’s customers possess a high level of technological sophistication such that any engineer who is following Arista’s instruction can [REDACTED].” (Tr. (Almeroth) at 114:17-23, 116:1-117:8; JX- 9017 (Arista Parser 101) at 1.). There is no evidence of the level of sophistication of Arista’s customers of its Redesigned Switches. Therefore, Cisco’s broad conclusion is unsupported.

The weight of the evidence also demonstrates that Arista did not possess the requisite intent for customers to indirectly infringe the ’577 patent with respect to filtered port mirroring functionality in Redesigned Switches. *See Global-Tech*, 131 S.Ct. at 2068 (synchronizing the knowledge requirement for contributory and induced infringement and holding that “induced infringement under § 271(b) requires knowledge that the induced acts constitute patent infringement.”); *DSU Med. Corp. v. JMS Co.*, 471 F.3d 1293, 1307 (Fed. Cir. 2006) (upholding

jury's verdict of no induced infringement based on evidence that the defendant believed that its product does not infringe).

There is no dispute that Arista knowingly encouraged its customers to use [REDACTED] ACLs with port mirroring on Arista's Redesigned Switches. (Tr. (Almeroth) at 132:6-14 (2018 Hearing); JX-9020 at 742; CX-9121C at 1.). However, Arista appears to have done so with a good-faith belief that filtered port mirroring do not infringe. Arista presented compelling evidence that persons of ordinary skill in the art viewed filtered port mirroring as fundamentally different from "access control." (Tr. (Black) at 303:16-304:8; RX-9001C (Sweeney Witness Statement) at Q/A 240; JX-9023C (Maltz Decl.) at 2; RDX-9000C-8 (Cisco materials distinguishing between the use of the term ACL and access control).). At the close of the Underlying Investigation, Arista [REDACTED] ACL" functionality and [REDACTED] from its Redesigned Switches out of [REDACTED] [REDACTED]. (RX-9001C (Sweeney Witness Statement) at Q/A 361-363.). Yet, Arista left filtered port mirroring untouched, suggesting that Arista did not consider it capable of infringing.

Cisco did not specifically accuse filtered port mirroring of infringement in the Underlying Investigation, as required by Ground Rule 11.2. Instead of clearly explaining its reasoning for this omission, as shown below in Figure 23, Cisco modified an infringement demonstrative from the Underlying Investigation to include for the first time a mention of filtered port mirroring. (CDX-9003C-8.).

Figure 23: Cisco's Depiction of [REDACTED] ACL" Infringement

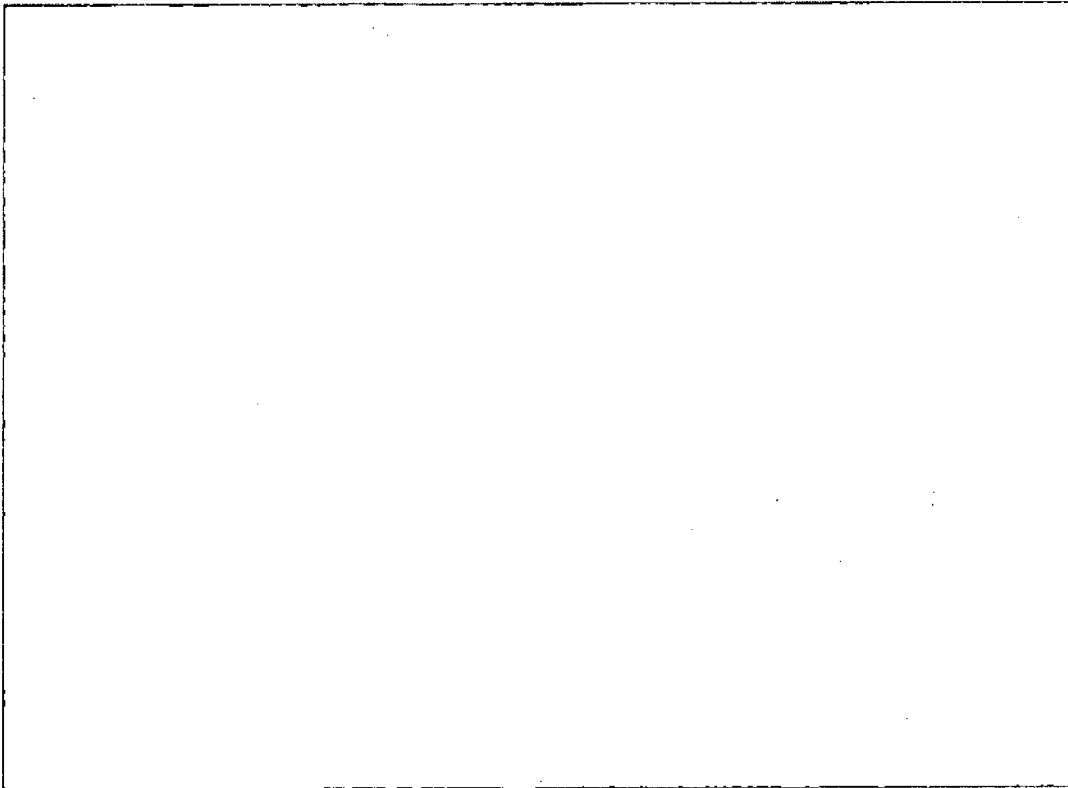

(CDX-9003C-8 (modified after the Underlying Investigation to accuse filtered port mirroring in this Modification Proceeding 2, presented by Dr. Almeroth during the 2018 Hearing).).

Dr. Almeroth testified about this alteration:

- Q:** And I think you described it as a demonstrative you had showed in the underlying investigation; right?
- A:** I was very clear that the underlying slide was without the red circle and then the blue bubbles on the left side with the arrows.
- Q:** Okay. So the blue bubbles were added; right?
- A:** Yes.
- Q:** You'll agree with me that the original slide didn't have any of these blue bubbles on it?
- A:** That's correct.
- Q:** Didn't mention port mirroring?
- A:** It did not specifically mention port mirroring.

(Tr. (Almeroth) at 132:6-14 (2018 Hearing)).

Any attempt by Cisco now to shoehorn filtered port mirroring into the umbrella category of infringing [REDACTED] ACL” functionality, to prove Arista’s intent to infringe, is at odds with this ID’s finding that filtered port mirroring does not infringe the ’577 patent. Arista’s behavior, documented in the evidentiary record, evinces a sincere belief that filtered port mirroring does not infringe the ’577 patent.

For these reasons, Cisco has not proven by a preponderance of the evidence that Arista possesses the intent to indirectly infringe the ’577 patent by inducing or contributing to direct infringement by its customers. This is because of Arista’s good-faith belief that filtered port mirroring did not infringe the ’577 patent, and Arista’s diligence in [REDACTED] [REDACTED] ACL” functionality in the Redesigned Switches. This conclusion holds regardless of whether Arista customers are found to have directly infringed the ’577 patent on review by using the accused filtered port mirroring functionality.

VI. CONCLUSIONS OF FACT OR LAW

1. The Commission has personal jurisdiction over the parties and subject matter and *in rem* jurisdiction over the Redesigned Switches.
2. Arista’s Redesigned Switches have been imported into the United States.
3. In the alternative, if the Commission does not adopt the Federal Circuit Court’s February 14, 2018 summary affirmance that the asserted claims of U.S. Patent No. 7,224,668 (“the ’668 patent) are invalid, the analysis reflected in this decision is that Cisco has proven by a preponderance of the evidence that Arista’s Redesigned Switches infringe asserted claims 1, 2, 4, 5, 7, 8, 10, 13, 18, 55, 56, and 64 of the ’668 patent.
4. Cisco has not proven by a preponderance of the evidence that the Redesigned Switches infringe asserted claims 1, 7, 9, 10, and 15 of U.S. Patent No. 6,377,577.
5. In the event the Commission does not adopt the Federal Circuit Court’s February 14, 2018 summary affirmance that the asserted claims of the ’668 patent

PUBLIC VERSION

are invalid, Cisco has proven that Arista has violated Section 337 of the Tariff Act of 1930, as amended.

This Initial Determination's failure to discuss any matter raised by the Parties, or any portion of the record, does not indicate that it has not been considered. Rather, any such matter(s) or portion(s) of the record has/have been determined to be irrelevant, immaterial or meritless. Arguments made on brief which were otherwise unsupported by record evidence or legal precedent have been accorded no weight.

VII. RECOMMENDED DETERMINATION ON REMEDY

The Commission's Rules provide that subsequent to an Initial Determination on the question of violation of Section 337 of the Tariff Act of 1930, as amended, 19 U.S.C. § 1337, the Administrative Law Judge shall issue a recommended determination containing findings of fact and recommendations concerning: (1) the appropriate remedy in the event that the Commission finds a violation of Section 337; and (2) the amount of bond to be posted by respondents during Presidential review of Commission action under Section 337(j). *See* 19 C.F.R. § 210.42(a)(1)(ii).

This decision recommends that the currently enforced Limited Exclusion Order ("LEO") and the Cease and Desist Order ("CDO") issued against Arista be modified or rescinded with respect to U.S. Patent No. 6,377,577.

This decision recognizes that notwithstanding that Cisco is unlikely to win on the merits that claims 1, 2, 4, 5, 7, 8, 10, 13, 18, 56, and 64 of the '668 patent are not invalid, the Commission Rules provide that the legal status of the claims at issue will not change unless and until the United States Patent and Trademark Office issues a certificate cancelling the claims

PUBLIC VERSION

following the exhaustion of all appeals. 35 U.S.C. § 318 (“If the Patent Trial and Appeal Board issues a final decision under subsection (a) and the time for appeal has expired or any appeal has terminated, the Director shall issue and public a certificate cancelling any claim of the patent finally determined to be unpatentable...). Consequently, this decision recommends that the currently enforced LEO and CDO issued against Arista be modified to include the Redesigned Switches.

VIII. INITIAL DETERMINATION

It is my Initial Determination on Violation of Section 337 that Arista Networks, Inc. has violated Section 337 of the Tariff Act of 1930, as amended, by importing into the United States, selling for importation, or selling within the United States after importation certain network devices, related software, and components thereof, because PDP and PEAC functionalities contained within Arista’s Redesigned Switches infringe claims 1, 2, 4, 5, 7, 8, 10, 13, 18, 55, 56, and 64 of U.S. Patent No. 7,224,668.

It is my Initial Determination on Violation of Section 337 that Arista Networks, Inc. has not violated Section 337 of the Tariff Act of 1930, as amended, because Arista’s Redesigned Switches do not infringe claims 1, 7, 9, 10 and 15 of U.S. Patent No. 6,377,577.

This decision is certified to the Commission. All orders and documents, filed with the Secretary, including the exhibit lists enumerating the exhibits received into evidence in this Investigation, that are part of the record, as defined in 19 C.F.R. § 210.38(a), are not certified, since they are already in the Commission’s possession in accordance with Commission Rules. *See* 19 C.F.R. § 210.38(a). In accordance with 19 C.F.R. § 210.39(c), any material found to be confidential by the undersigned under 19 C.F.R. § 210.5 is to be given *in camera* treatment.

PUBLIC VERSION

After the Parties have provided proposed redactions of confidential business information (“CBI”) that have been evaluated and accepted, the Secretary shall serve a public version of this ID upon all parties of record. The Secretary shall serve a confidential version upon counsel who are signatories to the Protective Order (Order No. 1) issued in this Investigation.

Pursuant to 19 C.F.R. § 210.42(h), this Initial Determination shall become the determination of the Commission unless a party files a petition for review pursuant to 19 C.F.R. § 210.43(a) or the Commission, pursuant to 19 C.F.R. § 210.44, orders on its own motion a review of the Initial Determination or certain issues therein.

Within fourteen (14) days of the date of this document, each party shall submit to the Office of Administrative Law Judges a joint statement regarding whether they seek to have any portion of this document deleted from the public version. The parties’ submission shall be made by hard copy and must include a copy of this Initial Determination on Violation with red brackets indicating any portion asserted to contain confidential business information to be deleted from the public version. The parties’ submission shall also include an index identifying the pages of this document where proposed redactions are located. The parties’ submission concerning the public version of this document need not be filed with the Commission Secretary.

SO ORDERED.

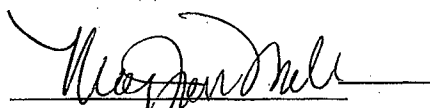

MaryJoan McNamara
Administrative Law Judge

APPENDIX A

Agreed Upon and Construed Claim Constructions

I. Claim Constructions of the '577 Patent

A. Agreed Terms

Term(s)	Agreed Construction
Preamble, '577 patent, claim 1	The parties agreed, and it has been construed, that the preamble is not limiting to the extent the preamble is “A method including the steps of.” To the extent the preamble also includes, “maintaining a set of access control patterns in at least one associative memory,” the preamble is limiting. (<i>Markman</i> Order at 12.).
“A method, including the steps of maintaining a set of access control patterns in at least one associative memory”	The parties agreed, and it has been construed, that “A method, including the steps of maintaining a set of access control patterns in at least one associative memory,” as it is used in the '577 patent need no further construction, given the previously-agreed constructions of “access control patterns” and “associative memory,” as well as the parties agreed-upon views as to the preamble. (SBr. at 5; CBr.II., Attach. I at 6.).
“associative memory”	The parties agreed, and it has been construed, that “associative memory,” as it is used in the '577 and '853 patents has its plain and ordinary meaning. (<i>Markman</i> Order at 12.).
“a hardware content-associative memory”	The parties agreed, and it has been construed, that “hardware content-associative memory,” as it is used in the '577 patent means “a content addressable memory.” (SBr. at 5; CBr.II, Attach. I at 7.).
“ternary content-associative memory”	The parties agreed, and it has been construed, that “ternary content-associative memory,” as it is used in the '577 patent means “a ternary content addressable memory.” (<i>Markman</i> Order at 12.).
“access control”	The parties agreed, and it has been construed, that “access control,” as it is used in the '577 and '853 patents

PUBLIC VERSION

	has its plain and ordinary meaning. (<i>Markman</i> Order at 12.).
“matchable information”	The parties agreed, and it has been construed, that “matchable information,” as it is used in the ’577 and ’853 patents has its plain and ordinary meaning. (<i>Markman</i> Order at 12.).
“said packet label being sufficient to perform access control processing for said packet”	The parties agreed, and it has been construed, that “said packet label being sufficient to perform access control processing for said packet,” as it is used in the ’853 patent has its plain and ordinary meaning. (<i>Markman</i> Order at 12.).
“forwarding permission”	The parties agreed, and it has been construed, that “forwarding permission,” as it is used in the ’853 patent has its plain and ordinary meaning. (<i>Markman</i> Order at 12.).

B. Construed Terms

Term(s)	Construed Construction
Claims 1 and 9 of the ’577 Patent; Claim 46 of the ’853 Patent “responsive to”	“Responsive to” has been construed to have its plain and ordinary meaning, including, but not limited to, “based on” or “derived from.” (<i>Markman</i> Order at 20; Complainant’s Opening Claim Construction Br. at 14 (May 15, 2015); Respondent’s Initial Claim Construction Br. at 8 (May 15, 2015); Staff’s Initial Claim Construction Br. at 9 (May 22, 2015).).
Claim 63 “access control specifier”	“Access control specifier” has been construed to mean “a specifier that includes information for matching with a packet and that may indicate, or aid in indicating, an access result.” (<i>Markman</i> Order at 32.).

II. Claim Constructions of the ’668 Patent

A. Agreed Terms

PUBLIC VERSION

Term(s)	Agreed Construction
Claim 3— <i>“information implicit to the packets”</i>	The parties agreed, and it has been construed, that “information implicit to the packets,” as it is used in the ’668 patent, should have its plain and ordinary meaning. (<i>Markman</i> Order at 52.).

B. Construed Terms

Term(s)	Construed Construction
Claim 1— <i>“specific, predetermined physical ports”</i>	“Specific, predetermined physical ports” does not require construction and should have its plain and ordinary meaning. ⁶⁸ (<i>Markman</i> Order at 59.).
Claim 1 <i>“independent of the physical port interfaces and services applied thereto”/“independent of the individual physical port interface configuration and port services applied thereto”</i>	“Independent of the physical port interfaces and services applied thereto” and “independent of the individual physical port interface configuration and port services applied thereto” have their plain and ordinary meanings. (<i>Markman</i> Order at 63).

⁶⁸ Under the broadest reasonable interpretation of “specific, predetermined ports,” the PTAB construed the term to “encompass[] all ports of the networking device, and is not limited to a subset of the ports.” (IPR2016-00309, Paper 8 at 8 (June 11, 2016)).

APPENDIX B

Hardware/Software Combinations for Arista's Legacy and Redesigned Switches

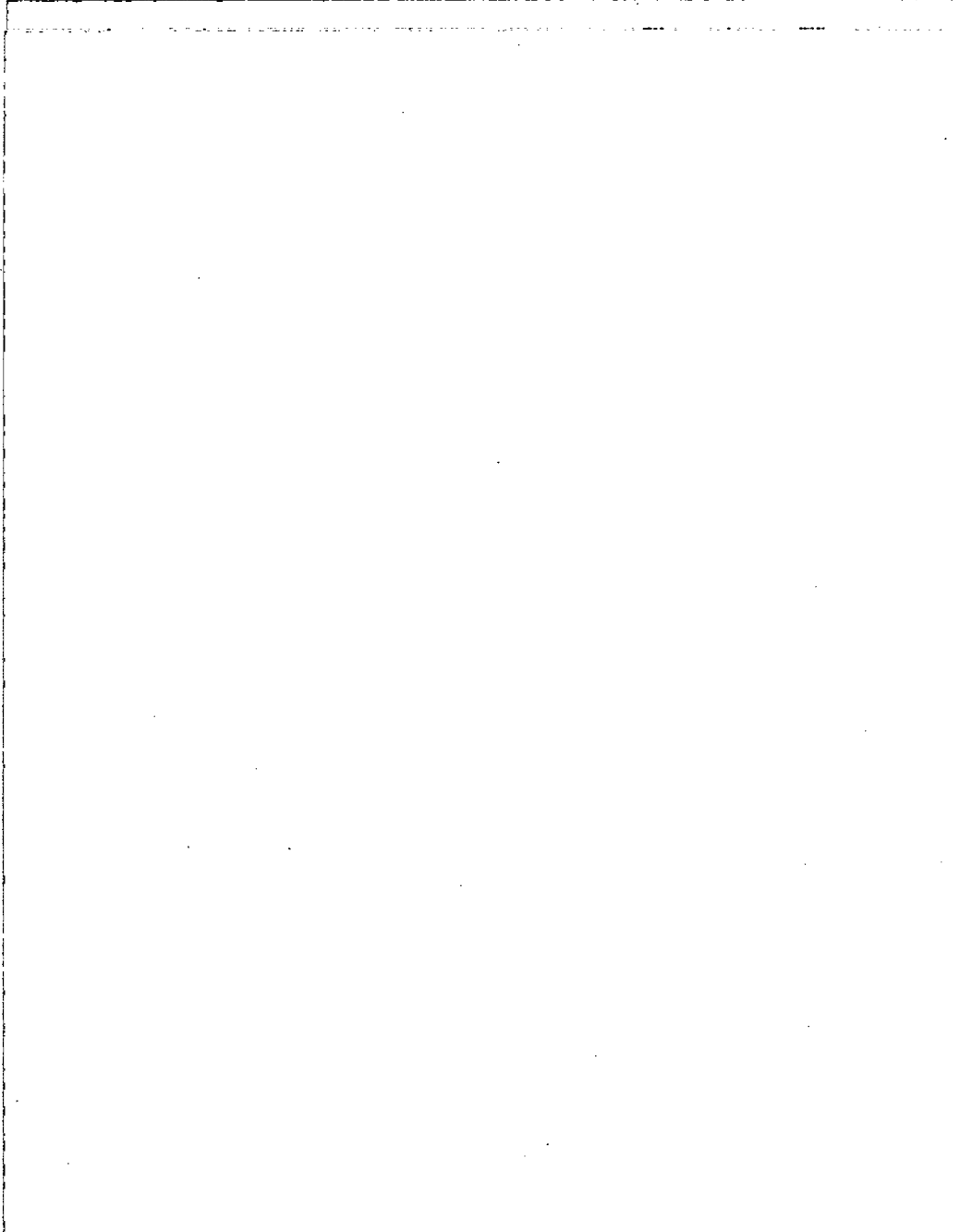

(RBr., App. C.).

PUBLIC CERTIFICATE OF SERVICE

I, Lisa R. Barton, hereby certify that the attached **INITIAL DETERMINATION** has been served upon the following parties as indicated, on **April 12, 2018**.



Lisa R. Barton, Secretary
U.S. International Trade Commission
500 E Street, SW, Room 112
Washington, DC 20436

On Behalf of Complainant Cisco Systems, Inc.:

Adam R. Alper, Esq.
KIRKLAND & ELLIS LLP
555 California Street
San Francisco, CA 94104

- Via Hand Delivery
- Via Express Delivery
- Via First Class Mail
- Other: _____

On Behalf of Respondent Arista Networks, Inc.:

Bert C. Reiser, Esq.
LATHAM & WATKINS LLP
555 Eleventh Street, NW, Suite 1000
Washington, DC 20004

- Via Hand Delivery
- Via Express Delivery
- Via First Class Mail
- Other: _____

UNITED STATES INTERNATIONAL TRADE COMMISSION
Washington, D.C.

In the Matter of

CERTAIN NETWORK DEVICES,
RELATED SOFTWARE AND
COMPONENTS THEREOF (II)

Investigation No. 337-TA-945

NOTICE OF COMMISSION FINAL DETERMINATION OF VIOLATION
OF SECTION 337; TERMINATION OF INVESTIGATION;
ISSUANCE OF LIMITED EXCLUSION ORDER AND CEASE AND DESIST ORDER

AGENCY: U.S. International Trade Commission.

ACTION: Notice.

SUMMARY: Notice is hereby given that the U.S. International Trade Commission has found a violation of section 337 of the Tariff Act of 1930, as amended, 19 U.S.C. § 1337 (“section 337”) in the above-captioned investigation. The Commission has determined to issue a limited exclusion order. The investigation is terminated.

FOR FURTHER INFORMATION CONTACT: Megan M. Valentine, Office of the General Counsel, U.S. International Trade Commission, 500 E Street, S.W., Washington, D.C. 20436, telephone (202) 708-2301. Copies of non-confidential documents filed in connection with this investigation are or will be available for inspection during official business hours (8:45 a.m. to 5:15 p.m.) in the Office of the Secretary, U.S. International Trade Commission, 500 E Street, S.W., Washington, D.C. 20436, telephone (202) 205-2000. General information concerning the Commission may also be obtained by accessing its Internet server at <https://www.usitc.gov>. The public record for this investigation may be viewed on the Commission’s electronic docket (EDIS) at <https://edis.usitc.gov>. Hearing-impaired persons are advised that information on this matter can be obtained by contacting the Commission’s TDD terminal on (202) 205-1810.

SUPPLEMENTARY INFORMATION: The Commission instituted this investigation on January 27, 2015, based on a Complaint filed by Cisco Systems, Inc. of San Jose, California (“Cisco”). 80 FR 4313-14 (Jan. 27, 2015). The Complaint alleges violations of section 337 of the Tariff Act of 1930, as amended, 19 U.S.C. § 1337, in the sale for importation, importation, and sale within the United States after importation of certain network devices, related software and components thereof by reason of infringement of certain claims of U.S. Patent Nos. 7,023,853; 6,377,577; 7,460,492; 7,061,875; 7,224,668; and 8,051,211. The Complaint further alleges the existence of a domestic industry. The Commission’s Notice of Investigation named Arista Networks, Inc. of Santa Clara, California (“Arista”) as respondent. The Office of Unfair Import Investigations (“OUII”) was also named as a party to the investigation. The Commission previously terminated the investigation in part as to certain claims of the asserted patents. Order

No. 38 (Oct. 27, 2015), unreviewed Notice (Nov. 18, 2015); Order No. 47 (Nov. 9, 2015), unreviewed Notice (Dec. 1, 2015).

On December 9, 2016, the ALJ issued her Final ID, finding a violation of section 337 with respect to claims 1, 7, 9, 10, and 15 of the '577 patent; and claims 1, 2, 4, 5, 7, 8, 10, 13, 18, 56, and 64 of the '668 patent. The ALJ found no violation of section 337 with respect to claim 2 of the '577 patent; claims 46 and 63 of the '853 patent; claims 1, 3, and 4 of the '492 patent; claims 1-4, and 10 of the '875 patent; and claims 2, 6, 13, and 17 of the '211 patent.

In particular, the Final ID finds that Cisco has shown by a preponderance of the evidence that the accused products infringe asserted claims 1, 7, 9, 10, and 15 of the '577 patent; and asserted claims 1, 2, 4, 5, 7, 8, 10, 13, 18, 56, and 64 of the '668 patent. The Final ID finds that Cisco has failed to show by a preponderance of the evidence that the accused products infringe asserted claim 2 of the '577 patent; asserted claims 46 and 63 of the '853 patent; asserted claims 1, 3, and 4 of the '492 patent; asserted claims 1-4, and 10 of the '875 patent; and asserted claims 2, 6, 13, and 17 of the '211 patent.

The Final ID also finds that assignor estoppel bars Arista from asserting that the '577 and '853 patents are invalid. The Final ID finds, however, that if assignor estoppel did not apply, Arista has shown by clear and convincing evidence that claims 1, 7, 9, 10, and 15 of the '577 patent and claim 46 of the '853 patent are invalid as anticipated by U.S. Patent No. 5,920,886 ("Feldmeier"). The Final ID further finds that Arista has failed to show by clear and convincing evidence that any of the remaining asserted claims are invalid. The Final ID also finds that Arista has not proven by clear and convincing evidence that Cisco's patent claims are barred by equitable estoppel, waiver, implied license, laches, unclean hands, or patent misuse.

The Final ID finds that Cisco has satisfied the economic prong of the domestic industry requirement for all of the patents-in-suit pursuant to 19 U.S.C. § 337(A), (B), and (C). The Final ID finds, however, that Cisco has failed to satisfy the technical prong of the domestic industry requirement with respect to the '875, '492, and '211 patents. The Final ID finds that Cisco has satisfied the technical prong with respect to the '577, '853, and '668 patents.

The Final ID also contains the ALJ's recommended determination on remedy and bonding. The ALJ recommended that the appropriate remedy is a limited exclusion order with a certification provision and a cease and desist order against Arista. The ALJ recommended the imposition of a bond of five (5) percent during the period of Presidential review.

On December 29, 2016, Cisco, Arista, and OUII each filed petitions for review of various aspects of the Final ID. On January 10, 2017, Cisco, Arista, and OUII filed responses to the various petitions for review.

On January 11, 2017, Cisco and Arista each filed a post-RD statement on the public interest pursuant to Commission Rule 210.50(a)(4). No responses were filed by the public in response to the post-RD Commission Notice issued on December 20, 2016. See Notice of Request for Statements on the Public Interest (Dec. 20, 2016); 81 FR 95194-95 (Dec. 27, 2016).

On March 1, 2017, the Commission determined to review the Final ID in part. Notice of

Review (Mar. 1, 2017); 82 FR 12844-47 (Mar. 7, 2017).

With respect to the '577 patent, the Commission determined to review the Final ID's finding that Arista has indirectly infringed the '577 patent by importing Imported Components, as referenced at page 110 in the Final ID. The Commission also determined to review the Final ID's finding that Arista's post-importation direct infringement cannot alone support a finding of violation of section 337. The Commission further determined to review the Final ID's finding that Feldmeier anticipates claims 1, 7, 9, 10, and 15 of the '577 patent.

With respect to the '853 patent, the Commission determined to review the Final ID's claim construction findings with respect to claim elements (c), (d), and (f) of claim 46. The Commission also determined to review the Final ID's findings concerning direct and indirect infringement regarding the '853 patent. The Commission further determined to review the Final ID's finding that assignor estoppel applies to validity challenges based on indefiniteness. The Commission also determined to review the Final ID's finding that Feldmeier does not anticipate claim 46.

With respect to the '875 and '492 patents, the Commission determined to review the Final ID's finding of no direct infringement and the related finding of no indirect infringement. The Commission also determined to review the Final ID's finding that Cisco has failed to satisfy the technical prong of the domestic industry requirement with respect to the '875 and '492 patents.

With respect to the '668 patent, the Commission determined to review the Final ID's finding of direct infringement and the Final ID's finding of indirect infringement, in particular as concerns Arista's importation of Imported Components.

With respect to the '211 patent, the Commission determined to review the Final ID's finding that Cisco has failed to satisfy the technical prong with respect to claims 1 and 12 of the '211 patent, including the Final ID's finding that claims 1 and 12 are invalid.

The Commission determined not to review the remaining issues decided in the Final ID.

The Commission also requested briefing from the parties on nine questions concerning the issues under review, as well as remedy, the public interest, and bonding. See Notice of Review at 4-5; 82 FR at 12845-46.

On March 15, 2017, the parties submitted initial briefing in response to the notice of review. On March 24, 2017, the parties filed response submissions.

Having examined the record of this investigation, including the Final ID, the petitions for review, the responses thereto, and the parties' submissions on review, the Commission has determined to find that a violation of section 337 has occurred with respect to the asserted claims of the '577 and '668 patents.

Specifically, with respect to the '577 patent, the Commission did not review the Final ID's finding that all of Arista's Accused ACL Products directly infringe claims 1, 7, 9-10, and 13 of the '577 patent. The Commission has determined to affirm the Final ID's finding that Arista

induces infringement of the '577 patent by importing both the Blank Switches and Imported Components (as defined at Final ID at 110 and Respondent Arista Networks Inc.'s Petition for Review of the Initial Determination on Violation of Section 337 (Dec. 29, 2016) at 77, 80). The Commission has further determined to affirm the Final ID's finding that Arista contributorily infringes by importing the Blank Switches. The Commission has determined not to reach the issue of whether Arista contributorily infringes the asserted claims of the '577 patent by importing the Imported Components. Based on the Final ID's unreviewed finding that assignor estoppel applies with respect to the '577 patent, the Commission has determined not to reach the issue of whether Feldmeier anticipates the '577 patent.

With respect to the '668 patent, the Commission has determined to affirm the Final ID's finding that several variations of the '668 Accused Products—including Control-Plane Access Control List, Control Plane Policing, and non-configurable Per-Input Port Control Plane Policing ("PiP CoPP")—infringe asserted claims 1, 2, 4, 5, 7, 8, 10, 13, 56, and 64 of the '668 patent, and to affirm with modification the Final ID's finding that the variation including configurable PiP CoPP infringes those claims, to supply the Commission's reasoning. With respect to claim 64, the Commission has determined to affirm with modification the Final ID's finding of infringement with respect to claim 64 to correct a misstatement in the Final ID. The Commission has also determined to affirm the Final ID's finding that Arista induces infringement of the asserted claims of the '668 patent by importing fully assembled Blank Switches and the Imported Components. The Commission has further determined to affirm the Final ID's finding that Arista contributorily infringes asserted claims 1, 2, 4, 5, 7, 8, 10, 13, 56, and 64 by importing fully assembled Blank Switches. The Commission has determined not to reach the issue of whether Arista contributorily infringes the asserted claims of the '668 patent by importing the Imported Components.

The Commission has determined to find no violation of section 337 with respect to the remaining asserted claims of the '853, '875, '492, and '211 patents.

Specifically, with respect to the '853 patent, the Commission has determined to affirm with modification, to supply the Commission's reasoning, the Final ID's finding that Arista's Accused ACL Products do not directly infringe claim 46, and to affirm the Final ID's finding that Arista does not directly infringe claim 63 of the '853 patent. Accordingly, the Commission has determined to affirm the Final ID's finding of no indirect infringement with respect to those claims. Based on the Final ID's unreviewed finding that assignor estoppel applies with respect to the '853 patent, the Commission has determined not to reach the issue of whether Feldmeier anticipates the '853 patent.

With respect to the '875 and '492 patents, the Commission has determined to affirm with modification the Final ID's finding of no infringement of the asserted claims and that Cisco has failed to satisfy the technical prong of the domestic industry requirement.

With respect to the '211 patent, the Commission did not review the Final ID's finding of no infringement with respect to the asserted claims of the '211 patent. The Commission has also determined to vacate the Final ID's finding with respect to the validity of claims 1 and 12 of the '211 patent, and declines to reach the technical prong issue.

The Commission has determined that the appropriate form of relief is a limited exclusion order under 19 U.S.C. § 1337(d)(1), prohibiting the unlicensed entry of network devices, related software and components thereof that infringe any of claims 1, 7, 9, 10, and 15 of the '577 patent; and claims 1, 2, 4, 5, 7, 8, 10, 13, 18, 56, and 64 of the '668 patent, and an order that Arista cease and desist from importing, selling, marketing, advertising, distributing, transferring (except for exportation), soliciting United States agents or distributors, and aiding or abetting other entities in the importation, sale for importation, sale after importation, transfer (except for exportation), or distribution of certain network devices, related software and components thereof that infringe any of claims 1, 7, 9, 10, and 15 of the '577 patent; and claims 1, 2, 4, 5, 7, 8, 10, 13, 18, 56, and 64 of the '668 patent.

The Commission has determined that the public interest factors enumerated in section 337(d) and (f), 19 U.S.C. § 1337(d) and (f), do not preclude the issuance of the limited exclusion order or cease and desist order. The Commission has determined that bonding at five (5) percent of the entered value of the covered products is required during the period of Presidential review, 19 U.S.C. § 1337(j).

The Commission's order and opinion were delivered to the President and the United States Trade Representative on the day of their issuance.

The investigation is terminated.

The authority for the Commission's determination is contained in section 337 of the Tariff Act of 1930, as amended (19 U.S.C. § 1337), and in Part 210 of the Commission's Rules of Practice and Procedure (19 C.F.R. Part 210).

By order of the Commission.



Lisa R. Barton
Secretary to the Commission

Issued: May 4, 2017

PUBLIC CERTIFICATE OF SERVICE

I, Lisa R. Barton, hereby certify that the attached **NOTICE** has been served by hand upon the Commission Investigative Attorney, Monica Bhattacharyya, Esq., and the following parties as indicated, on **May 4, 2017**.



Lisa R. Barton, Secretary
U.S. International Trade Commission
500 E Street, SW, Room 112
Washington, DC 20436

On Behalf of Complainant Cisco Systems, Inc.:

Adam R. Alper, Esq.
KIRKLAND & ELLIS LLP
555 California Street
San Francisco, CA 94104

- Via Hand Delivery
- Via Express Delivery
- Via First Class Mail
- Other: _____

On Behalf of Respondent Arista Networks, Inc.:

Bert C. Reiser, Esq.
LATHAM & WATKINS LLP
555 Eleventh Street, NW, Suite 1000
Washington, DC 20004

- Via Hand Delivery
- Via Express Delivery
- Via First Class Mail
- Other: _____

UNITED STATES INTERNATIONAL TRADE COMMISSION
WASHINGTON, D.C.

In the Matter of

**CERTAIN NETWORK DEVICES,
RELATED SOFTWARE AND
COMPONENTS THEREOF (II)**

Investigation No. 337-TA-945

LIMITED EXCLUSION ORDER

The United States International Trade Commission (“Commission”) has determined that there is a violation of section 337 of the Tariff Act of 1930, as amended (19 U.S.C. § 1337), in the unlawful importation, sale for importation, or sale within the United States after importation by Respondent Arista Networks, Inc. of Santa Clara, California (“Arista”) of certain network devices, related software and components thereof covered by one or more of claims 1, 7, 9, 10, and 15 of U.S. Patent No. 6,377,577 (“the ’577 patent”); and asserted claims 1, 2, 4, 5, 7, 8, 10, 13, 18, 56, and 64 of U.S. Patent No. 7,224,668 (“the ’668 patent”) (“Asserted Patents”).

Having reviewed the record in this investigation, including the written submissions of the parties, the Commission has made its determination on the issues of remedy, public interest, and bonding. The Commission has determined that the appropriate form of relief is a limited exclusion order prohibiting the unlicensed entry of certain covered network devices, related software and components thereof manufactured by or on behalf of Arista or any of their affiliate companies, parents, subsidiaries, licensees, or other related business entities, or their successors or assigns.

The Commission has also determined that the public interest factors enumerated in

19 U.S.C. § 1337(d) do not preclude the issuance of the limited exclusion order, and that the bond during the period of Presidential review shall be in the amount of five (5) percent of the entered value of the covered products.

Accordingly, the Commission hereby **ORDERS** that:

1. Network devices, related software and components thereof covered by one or more of claims 1, 7, 9, 10, and 15 of the '577 patent; and claims 1, 2, 4, 5, 7, 8, 10, 13, 18, 56, and 64 of the '668 patent that are manufactured abroad by, or on behalf of, or imported by or on behalf of Arista, or any of their affiliated companies, parents, subsidiaries, agents, or other related business entities, or their successors or assigns, are excluded from entry for consumption into the United States, entry for consumption from a foreign-trade zone, or withdrawal from a warehouse for consumption, for the remaining terms of the patents, except under license of the patent owner or as provided by law, and except for service or repair articles imported for use in servicing or repairing network devices under warranty or service contracts, for identical articles, that existed as of the date of this Order.
2. Notwithstanding paragraph 1 of this Order, the aforesaid network devices, related software and components thereof are entitled to entry into the United States for consumption, entry for consumption from a foreign trade zone, or withdrawal from a warehouse for consumption, under bond in the amount of five (5) percent of the entered value of the covered products pursuant to subsection (j) of Section 337 of the Tariff Act of 1930, as amended (19 U.S.C. § 1337(j)), and the Presidential Memorandum for the United States Trade Representative of

July 21, 2005 (70 *Fed. Reg.* 43,251), from the day after this Order is received by the United States Trade Representative, and until such time as the United States Trade Representative notifies the Commission that this action is approved or disapproved but, in any event, not later than sixty (60) days after the receipt of this Order.

3. At the discretion of U.S. Customs and Border Protection (“CBP”) and pursuant to the procedures it establishes, persons seeking to import network devices, related software and components thereof that are potentially subject to this Order may be required to certify that they are familiar with the terms of this Order, that they have made appropriate inquiry, and thereupon state that, to the best of their knowledge and belief, the products being imported are not excluded from entry under paragraph 1 of this Order. At its discretion, CBP may require persons who have provided the certification described in this paragraph to furnish such records or analyses as are necessary to substantiate this certification.
4. In accordance with 19 U.S.C. § 1337(l), the provisions of this Order shall not apply to network devices, related software and components thereof that are imported by or for the use of the United States, or imported for and to be used for, the United States with the authorization or consent of the Government.
5. The Commission may modify this Order in accordance with the procedures described in Rule 210.76 of the Commission’s Rules of Practice and Procedure (19 C.F.R. § 210.76).
6. The Secretary shall serve copies of this Order upon each party of record in this Investigation and CBP.

7. Notice of this Order shall be published in the *Federal Register*.

By order of the Commission.

A handwritten signature in black ink, appearing to read 'Lisa R. Barton', written in a cursive style.

Lisa R. Barton
Secretary to the Commission

Issued: May 4, 2017

**CERTAIN NETWORK DEVICES, RELATED SOFTWARE
AND COMPONENTS THEREOF (II)**

Inv. No. 337-TA-945

PUBLIC CERTIFICATE OF SERVICE

I, Lisa R. Barton, hereby certify that the attached **ORDER** has been served by hand upon the Commission Investigative Attorney, Monica Bhattacharyya, Esq., and the following parties as indicated, on **May 4, 2017**.



Lisa R. Barton, Secretary
U.S. International Trade Commission
500 E Street, SW, Room 112
Washington, DC 20436

On Behalf of Complainant Cisco Systems, Inc.:

Adam R. Alper, Esq.
KIRKLAND & ELLIS LLP
555 California Street
San Francisco, CA 94104

- Via Hand Delivery
- Via Express Delivery
- Via First Class Mail
- Other: _____

On Behalf of Respondent Arista Networks, Inc.:

Bert C. Reiser, Esq.
LATHAM & WATKINS LLP
555 Eleventh Street, NW, Suite 1000
Washington, DC 20004

- Via Hand Delivery
- Via Express Delivery
- Via First Class Mail
- Other: _____

UNITED STATES INTERNATIONAL TRADE COMMISSION
WASHINGTON, D.C.

In the Matter of

**CERTAIN NETWORK DEVICES, RELATED
SOFTWARE AND COMPONENTS
THEREOF (II)**

Investigation No. 337-TA-945

CEASE AND DESIST ORDER

IT IS HEREBY ORDERED THAT RESPONDENT Arista Networks, Inc. of Santa Clara, California 95054 (“Arista”) cease and desist from conducting any of the following activities in the United States: importing, selling, marketing, advertising, distributing, transferring (except for exportation), soliciting United States agents or distributors, and aiding or abetting other entities in the importation, sale for importation, sale after importation, transfer (except for exportation), or distribution of certain network devices, related software and components thereof covered by one or more of claims 1, 7, 9, 10, and 15 of U.S. Patent No. 6,377,577 (“the ’577 patent”); and claims 1, 2, 4, 5, 7, 8, 10, 13, 18, 56, and 64 of U.S. Patent No. 7,224,668 (“the ’668 patent”) in violation of Section 337 of the Tariff Act of 1930, as amended (19 U.S.C. § 1337).

**I.
Definitions**

As used in this Order:

- (A) “Commission” shall mean the United States International Trade Commission.
- (B) “Complainant” shall mean Cisco Systems, Inc. of San Jose, California.
- (C) “Respondent” shall mean Arista Networks, Inc. of Santa Clara, California.
- (D) “Person” shall mean an individual, or any non-governmental partnership, firm, association, corporation, or other legal or business entity other than Respondent or its majority-owned or controlled subsidiaries, successors, or assigns.

- (E) "United States" shall mean the fifty States, the District of Columbia, and Puerto Rico.
- (F) The terms "import" and "importation" refer to importation for entry for consumption under the Customs laws of the United States.
- (G) The term "covered products" shall mean network devices, related software and components thereof covered by one or more of claims 1, 7, 9, 10 and 15 of the '577 patent; and claims 1, 2, 4, 5, 7, 8, 10, 13, 18, 56 and 64 of the '668 patent.

II. Applicability

The provisions of this Cease and Desist Order shall apply to Respondent and to any of its principals, stockholders, officers, directors, employees, agents, licensees, distributors, controlled (whether by stock ownership or otherwise) and majority-owned business entities, successors, and assigns, and to each of them, insofar as they are engaging in conduct prohibited by Section III, *infra*, for, with, or otherwise on behalf of, Respondent.

III. Conduct Prohibited

The following conduct of Respondent in the United States is prohibited by this Order. For the remaining terms of the Asserted Patents, the Respondent shall not:

- (A) import or sell for importation into the United States covered products;
- (B) market, distribute, sell, or otherwise transfer (except for exportation) imported covered products;
- (C) advertise imported covered products;
- (D) solicit U.S. agents or distributors for imported covered products; or
- (E) aid or abet other entities in the importation, sale for importation, sale after importation, transfer, or distribution of covered products.

**IV.
Conduct Permitted**

Notwithstanding any other provision of this Order, specific conduct otherwise prohibited by the terms of this Order shall be permitted if:

- (A) in a written instrument, the owner of the '577 patent and the '668 patent authorizes or licenses such specific conduct, or such specific conduct is related to the importation or sale of covered products by or for the United States; or
- (B) the conduct is limited to provision of service or repair articles imported for use in servicing or repairing network devices under warranty of service contracts, for identical articles, that existed prior to the date of this Order.

**V.
Reporting**

For purposes of this requirement, the reporting periods shall commence on January 1 of each year and shall end on the subsequent December 31. The first report required under this section shall cover the period from the date of issuance of this Order through December 31, 2017. This reporting requirement shall continue in force until such time as Respondent has truthfully reported, in two consecutive timely filed reports, that it has no inventory of covered products in the United States.

Within thirty (30) days of the last day of the reporting period, Respondent shall report to the Commission: (a) the quantity in units and the value in dollars of covered products that it has (i) imported and/or (ii) sold in the United States after importation during the reporting period, and (b) the quantity in units and value in dollars of reported covered products that remain in inventory in the United States at the end of the reporting period.

When filing written submissions, Respondent must file the original document electronically on or before the deadlines stated above and submit eight (8) true paper copies to the Office of the Secretary by noon the next day pursuant to Section 210.4(f) of the Commission's

Rules of Practice and Procedure (19 C.F.R. § 210.4(f)). Submissions should refer to the investigation number (“Inv. No. 337-TA-945”) in a prominent place on the cover pages and/or the first page. *See Handbook for Electronic Filing Procedures*, http://www.usitc.gov/secretary/fed_reg_notices/rules/handbook_on_electronic_filing.pdf). Persons with questions regarding filing should contact the Secretary (202-205-2000). If Respondent desires to submit a document to the Commission in confidence, it must file the original and a public version of the original with the Office of the Secretary and must serve a copy of the confidential version on Complainant’s counsel.¹

Any failure to make the required report or the filing of any false or inaccurate report shall constitute a violation of this Order, and the submission of a false or inaccurate report may be referred to the U.S. Department of Justice as a possible criminal violation of 18 U.S.C. § 1001

VI. Record-Keeping and Inspection

- (A) For the purpose of securing compliance with this Order, Respondent shall retain any and all records relating to the sale, offer for sale, marketing, or distribution in the United States of covered products, made and received in the usual and ordinary course of business, whether in detail or in summary form, for a period of three (3) years from the close of the fiscal year to which they pertain.
- (B) For the purposes of determining or securing compliance with this Order and for no other purpose, subject to any privilege recognized by the federal courts of the United States, and upon reasonable written notice by the Commission or its staff, duly authorized representatives of the Commission shall be permitted access and the right to inspect and copy, in Respondent’s principal offices during office hours,

¹ Complainant must file a letter with the Secretary identifying the attorney to receive reports and bond information associated with this Order. The designated attorney must be on the protective order entered in the investigation.

and in the presence of counsel or other representatives if Respondent so chooses, all books, ledgers, accounts, correspondence, memoranda, and other records and documents, in detail and in summary form, that must be retained under subparagraph VI(A) of this Order.

**VII.
Service of Cease and Desist Order**

Respondent is ordered and directed to:

- (A) Serve, within fifteen (15) days after the effective date of this Order, a copy of this Order upon each of its respective officers, directors, managing agents, agents, and employees who have any responsibility for the importation, marketing, distribution, or sale of imported covered products in the United States;
- (B) Serve, within fifteen (15) days after the succession of any persons referred to in subparagraph VII(A) of this Order, a copy of the Order upon each successor; and
- (C) Maintain such records as will show the name, title, and address of each person upon whom the Order has been served, as described in subparagraphs VII(A) and VII(B) of this Order, together with the date on which service was made.

The obligations set forth in subparagraphs VII(B) and VII(C) shall remain in effect until the expiration date of the '577 patent and the '668 patent.

**VIII.
Confidentiality**

Any request for confidential treatment of information obtained by the Commission pursuant to Sections V and VI of this Order should be made in accordance with Section 201.6 of the Commission's Rules of Practice and Procedure (19 C.F.R. § 201.6). For all reports for which confidential treatment is sought, Respondent must provide a public version of such report with confidential information redacted.

IX.
Enforcement

Violation of this Order may result in any of the actions specified in Section 210.75 of the Commission's Rules of Practice and Procedure (19 C.F.R. § 210.75), including an action for civil penalties under Section 337(f) of the Tariff Act of 1930, as amended (19 U.S.C. § 1337(f)), as well as any other action that the Commission deems appropriate. In determining whether Respondent is in violation of this Order, the Commission may infer facts adverse to Respondent if it fails to provide adequate or timely information.

X.
Modification

The Commission may amend this Order on its own motion or in accordance with the procedure described in Section 210.76 of the Commission's Rules of Practice and Procedure (19 C.F.R. § 210.76).

XI.
Bonding

The conduct prohibited by Section III of this Order may be continued during the sixty-day period in which the Order is under review by the United States Trade Representative, as delegated by the President (70 Fed. Reg. 43,251 (Jul. 21, 2005)) subject to the Respondent's posting of a bond in the amount of five (5) percent of the entered value of the covered products. This bond provision does not apply to conduct that is otherwise permitted by Section IV of this Order. Covered products imported on or after the date of issuance of this Order are subject to the entry bond set forth in the exclusion Order issued by the Commission, and are not subject to this bond provision.

The bond is to be posted in accordance with the procedures established by the Commission for the posting of bonds by complainants in connection with the issuance of

temporary exclusion orders. *See* 19 C.F.R. § 210.68. The bond and any accompanying documentation are to be provided to and approved by the Commission prior to the commencement of conduct that is otherwise prohibited by section III of this Order. Upon the Secretary's acceptance of the bond, (a) the Secretary will serve an acceptance letter on all parties, and (b) Respondent must serve a copy of the bond and accompanying documentation on Complainant's counsel.²

The bond is to be forfeited in the event that the United States Trade Representative approves this Order (or does not disapprove it within the review period), unless (i) the U.S. Court of Appeals for the Federal Circuit, in a final judgment, reverses any Commission final determination and order as to Respondent on appeal, or (ii) Respondent exports or destroys the products subject to this bond and provides certification to that effect that is satisfactory to the Commission.

This bond is to be released in the event the United States Trade Representative disapproves this Order and no subsequent order is issued by the Commission and approved (or not disapproved) by the United States Trade Representative, upon service on Respondent of an order issued by the Commission based upon application therefore made by Respondent to the Commission.

By order of the Commission.



Lisa R. Barton
Secretary to the Commission

Issued: May 4, 2017

² *See* Footnote 1.

**CERTAIN NETWORK DEVICES, RELATED SOFTWARE
AND COMPONENTS THEREOF (II)**

Inv. No. 337-TA-945

PUBLIC CERTIFICATE OF SERVICE

I, Lisa R. Barton, hereby certify that the attached **ORDER** has been served by hand upon the Commission Investigative Attorney, Monica Bhattacharyya, Esq., and the following parties as indicated, on **May 4, 2017**.



Lisa R. Barton, Secretary
U.S. International Trade Commission
500 E Street, SW, Room 112
Washington, DC 20436

On Behalf of Complainant Cisco Systems, Inc.:

Adam R. Alper, Esq.
KIRKLAND & ELLIS LLP
555 California Street
San Francisco, CA 94104

- Via Hand Delivery
 Via Express Delivery
 Via First Class Mail
 Other: _____

On Behalf of Respondent Arista Networks, Inc.:

Bert C. Reiser, Esq.
LATHAM & WATKINS LLP
555 Eleventh Street, NW, Suite 1000
Washington, DC 20004

- Via Hand Delivery
 Via Express Delivery
 Via First Class Mail
 Other: _____

PUBLIC VERSION

**UNITED STATES INTERNATIONAL TRADE COMMISSION
Washington, D.C.**

In the Matter of

**CERTAIN NETWORK DEVICES,
RELATED SOFTWARE AND
COMPONENTS THEREOF (II)**

Investigation No. 337-TA-945

COMMISSION OPINION

I. BACKGROUND

The Commission instituted this investigation on January 27, 2015, based on a Complaint filed by Cisco Systems, Inc. of San Jose, California (“Cisco”). 80 *Fed. Reg.* 4313-14 (Jan. 27, 2015). The Complaint alleges violations of section 337 in the sale for importation, importation, and sale within the United States after importation of certain network devices, related software and components thereof, by reason of infringement of certain claims of U.S. Patent Nos. 7,023,853; 7,061,875; 7,460,492; 8,051,211; 6,377,577 (“the ’577 patent”); and 7,224,668 (“the ’668 patent”). The Complaint further alleges the existence of a domestic industry. The Commission’s Notice of Investigation names Arista Networks, Inc. of Santa Clara, California (“Arista”) as the respondent. The Office of Unfair Import Investigations (“OUII”) is also a party to the investigation. The Commission later terminated the investigation in part as to certain claims of the asserted patents. Notice (Nov. 18, 2015) (*see* Order No. 38 (Oct. 27, 2015)); Notice (Dec. 1, 2015) (*see* Order No. 47 (Nov. 9, 2015)).

On June 11, 2015, the U.S. Patent and Trademark Office (“PTO”) instituted separate *inter partes* review (“IPR”) proceedings concerning the ’577 and ’668 patents. *Arista Networks,*

PUBLIC VERSION

Inc. v. Cisco Systems, Inc., Case IPR2016-00303 (regarding the '577 patent); *Arista Networks, Inc. v. Cisco Systems, Inc.*, Case IPR2016-00309 (regarding the '668 patent).

On December 9, 2016, the presiding administrative law judge (“ALJ”) issued her Final initial determination (“ID”), finding a violation of section 337 with respect to asserted claims 1, 7, 9, 10, and 15 of the '577 patent; and asserted claims 1, 2, 4, 5, 7, 8, 10, 13, 18, 56, and 64 of the '668 patent. The ID found no violation of section 337 with respect to asserted claim 2 of the '577 patent and the asserted claims of the '853 patent, the '492 patent, the '875 patent, and the '211 patent.

The Final ID finds that the doctrine of assignor estoppel prevents Arista from challenging the validity of the '577 patent, but if assignor estoppel does not apply, that claims 1, 7, 9, 10, and 15 of the '577 patent are invalid as anticipated by U.S. Patent No. 5,920,886 (“Feldmeier”).¹ The Final ID also finds that U.S. Patent No. 6,081,522 to Hendel does not anticipate the asserted claims of the '577 patent and that U.S. Patent No. 5,938,736 to Muller in combination with Hendel does not render obvious claim 7 of the '577 patent.

The Final ID further finds that: (1) the asserted claims of the '668 patent are not anticipated by JUNOS Internet Software Configuration Guide, Interfaces, Class of Service, and Firewalls, Release 5.0 (“JUNOS Guide”) because the reference is not a prior art “printed publication” to the '668 patent, (2) that the asserted claims of the '668 patent are not anticipated by U.S. Patent No. 6,674,743 to Amara, and (3) that claim 7 of the '668 patent is not obvious in view of the combination of the JUNOS Guide and U.S. Patent No. 6,460,146 to Moberg, or in

¹ Arista did not contend that Feldmeier anticipates claim 2 of the '577 patent.

PUBLIC VERSION

view of the combination of Amara and Moberg; and (4) claims 10, 13, and 64 of the '668 patent are not obvious in view of the combination of JUNOS Guide and U.S. Patent No. 6,970,943 to Subramanian, or in view of the combination of Amara and Subramanian.

On March 1, 2017, the Commission determined to review the Final ID in part. Notice of Review (Mar. 1, 2017); 82 *Fed. Reg.* 12844-47 (Mar. 7, 2017). The Commission did not review the Final ID's finding that assignor estoppel applies to the '577 patent. The Commission did, however, review the Final ID's finding that Feldmeier anticipates claims 1, 7, 9, 10, and 15 of the '577 patent. The Commission did not review any of the Final ID's validity findings concerning the '668 patent.

On May 4, 2017, the Commission issued its final determination, finding a violation of section 337 with respect to claims 1, 7, 9-10, and 13 of the '577 patent and claims 1, 2, 4, 5, 7, 8, 10, 13, 18, 56, and 64 of the '668 patent. Notice (May 4, 2017); 82 *Fed. Reg.* 21827-29 (May 10, 2017). The Commission determined to issue a limited exclusion order and cease and desist order, (collectively, "remedial orders"), against respondent Arista. *Id.*²

On May 25, 2017, the Patent Trial and Appeal Board ("PTAB") of the U.S. Patent and Trademark Office ("PTO") issued its final written decision finding claims 1, 7-10, 12-16, 18-22, 25, and 28-31 of the '577 patent unpatentable based on prior art not presented in the Commission investigation. *See* Arista's Second Pet., Exh. 1, IPR2016-00303, Final Written Decision at 36.³

² The Commission further determined to impose a bond in the amount of 5 percent of the entered value of the infringing products during the period of Presidential review, which ended on July 3, 2017. *Id.*; *see* 19 U.S.C. §1337(j).

³ Arista asserted before the PTAB that the combination of U.S. Patent No. 5,467,349 to Huey and ATM User-Network Interface Specification, Version 3.0 (September 10, 1993) renders

PUBLIC VERSION

On June 1, 2017, the PTAB issued its final written decision finding claims 1-10, 12, 13, 15-28, 30, 33-36, 55-64, 66, 67, and 69-72 of the '668 patent unpatentable based on certain combinations of prior art not presented in the Commission investigation. *See id.*, Exh. 2, IPR2016-00309, Final Written Decision at 49.⁴

Arista filed an emergency petition to modify, suspend, or rescind the Commission's remedial orders pending appeal of the May 25, 2017 final written decision of the PTAB on May 30, 2017. The Commission's Docket Services rejected this petition because it did not comply with Commission Rules. Arista refiled the document on June 1, 2017.⁵ Arista also requested a shortened time for Cisco and OUII to file responses to the motion. On June 2, 2017, Cisco opposed Arista's request for a shortened response time.⁶

Arista filed a second emergency petition on June 2, 2017, to suspend or rescind the remedial orders pending appeal of both the May 25, 2017 and June 1, 2017 final written decisions of the PTAB.⁷ Arista incorporated its first petition by reference into the second

obvious certain claims of the '577 patent. *Id.* at 6.

⁴ Arista asserted before the PTAB that various combinations of U.S. Patent Nos. 6,674,743 to Amara; 6,460,146 to Moberg; 6,115,378 to Hendel; and 3Com, CoreBuilder 3500 Implementation Guide, MSD Technical Publication, November 1999, render obvious certain claims of the '668 patent. *Id.* at 6-7.

⁵ Respondent Arista Networks Inc.'s Emergency Petition to Modify, Suspend, or Rescind Remedial Orders Pending Appeal of the Patent Trial and Appeal Board's Invalidation of Complainant Cisco Systems, Inc.'s U.S. Patent No. 6,337,577 and Request for Shortened Response Time and Expedited Consideration (June 1, 2017) ("Arista's First Pet.").

⁶ Complainant Cisco Systems, Inc.'s Response to Arista Network Inc.'s Request for a Shortened Response Time Regarding Its Petition to Modify, Suspend, or Rescind Remedial Orders (June 2, 2017).

⁷ Respondent Arista Networks Inc.'s Emergency Petition to Suspend or Rescind Remedial

PUBLIC VERSION

petition. Arista's Second Pet. at 3. In its second petition, however, Arista omitted any reference to modifying the orders. Arista also requested a shortened time for Cisco and OUII to file responses to the motion.

On June 8, 2017, the parties filed a joint stipulation, agreeing that Cisco and OUII would each file a combined response to Arista's petitions by June 12, 2017.⁸ Pursuant to the Stipulation, on June 12, 2017, Cisco filed a response opposing Arista's petitions,⁹ and OUII filed a response in support of Arista's petitions.¹⁰

On June 14, 2017, Arista filed a motion for leave to reply in support of its petitions, with reply brief attached.¹¹ On June 20, 2017, Cisco filed an opposition to Arista's motion for leave.¹² OUII did not respond.

Orders Pending Appeal of the Patent Trial and Appeal Board's Invalidation of Complainant Cisco Systems, Inc.'s U.S. Patent Nos. 7,224,668 and 6,337,577 and Request for Shortened Response Time and Expedited Consideration (June 2, 2017) ("Arista's Second Pet.").

⁸ Joint Stipulation regarding Due Dates to Respond to Arista's Emergency Petitions to Modify, Suspend, or Rescind Remedial Orders (June 8, 2017) ("the Stipulation").

⁹ Complainant Cisco Systems, Inc.'s Opposition to Respondent Arista Networks Inc.'s Emergency Petition to Modify, Suspend, or Rescind Remedial Orders Pending Appeal of the PTAB Invalidation Of Complainant Patent Nos. 7,224,668 And 6,377,577 (June 12, 2017) ("Cisco Resp.").

¹⁰ The Office of Unfair Import Investigations' Response to Arista Networks Inc.'s Emergency Petitions to Suspend or Rescind Remedial Orders (June 12, 2017) ("OUII Resp.").

¹¹ Respondent Arista Networks Inc.'s Motion for Leave to File a Reply in Support of its Emergency Petition to Suspend or Rescind Remedial Orders Pending Appeal of the Patent Trial and Appeal Board's Invalidation of Complainant Cisco Systems, Inc.'s U.S. Patent Nos. 7,224,668 and 6,337,577 and Request for Shortened Response Time and Expedited Consideration (June 2, 2017) ("Arista's Mot. For Leave.").

¹² Complainant Cisco Systems, Inc.'s Opposition to Respondent Arista Networks Inc.'s Motion for Leave to File a Reply in Support of its Emergency Petition to Modify, Suspend, or

PUBLIC VERSION

On July 18, 2017, Arista filed a supplemental brief.¹³ The Commission finds the supplemental filing offers no new material information and that Arista has failed to show good cause why the Commission should consider this filing.

II. APPLICABLE LAW

Section 337(k), 19 U.S.C § 1337(k) provides as follows:

(1) Except as provided in subsections (f) and (j), any exclusion from entry or order under this section shall continue in effect until the Commission finds, and in the case of exclusion from entry notifies the Secretary of the Treasury, that the conditions which led to such exclusion from entry or order no longer exist.

(2) If any person who has previously been found by the Commission to be in violation of this section petitions the Commission for a determination that the petitioner is no longer in violation of this section or for a modification or rescission of an exclusion from entry or order under subsection (d), (e), (f), (g), or (i) –

(A) the burden of proof in any proceeding before the Commission regarding such petition shall be on the petitioner; and

(B) relief may be granted by the Commission with respect to such petition –

on the basis of new evidence or evidence that could not have been presented at the prior proceeding, or

Rescind Remedial Orders Pending Appeal of the Patent Trial and Appeal Board's Invalidation of Complainant Cisco Systems, Inc.'s U.S. Patent Nos. 7,224,668 And 6,377,577 and Request for Shortened Response Time and Expedited Consideration (June 20, 2017) ("Cisco's Opp. to Mot. For Leave").

¹³ Respondent Arista Networks Inc.'s Supplemental Brief Regarding June 2, 2017 Emergency Petition to Suspend or Rescind Remedial Orders Pending Appeal of the Patent Trial and Appeal Board's Invalidation of Complainant Cisco Systems, Inc.'s U.S. Patent Nos. 7,224,668 and 6,337,577 (July 18, 2017).

PUBLIC VERSION

on grounds which would permit relief from a judgment or order under the Federal Rules of Civil Procedure.

Commission Rule 210.76(a), which implements 19 U.S.C. § 1337(k), provides as follows:

(a) Petitions for modification or rescission of exclusion orders, cease and desist orders, and consent orders. (1) Whenever any person believes that changed conditions of fact or law, or the public interest, require that an exclusion order, cease and desist order, or consent order be modified or set aside, in whole or in part, such person may file with the Commission a petition requesting such relief. The Commission may also on its own initiative consider such action. The petition shall state the changes desired and the changed circumstances warranting such action, shall include materials and argument in support thereof, and shall be served on all parties to the investigation in which the exclusion order, cease and desist order, or consent order was issued. Any person may file an opposition to the petition within 10 days of service of the petition.

(2) If the petitioner previously has been found by the Commission to be in violation of section 337 of the Tariff Act of 1930 and if its petition requests a Commission determination that the petitioner is no longer in violation of that section or requests modification or rescission of an order issued pursuant to section 337(d), (e), (f), (g), or (i), of the Tariff Act of 1930, the burden of proof in any proceeding initiated in response to the petition pursuant to paragraph (b) of this section shall be on the petitioner. In accordance with section 337(k)(2) of the Tariff Act, relief may be granted by the Commission with respect to such petition on the basis of new evidence or evidence that could not have been presented at the prior proceeding or on grounds that would permit relief from a judgment or order under the Federal Rules of Civil Procedure.

III. SUMMARY OF THE PARTIES' ARGUMENTS

Arista argues that the conditions that lead the Commission to issue remedial orders no longer exist due to the PTAB's decisions finding the underlying claims unpatentable. Arista's Second Pet. at 9. Arista argues that controlling authority compels the suspension or temporary

PUBLIC VERSION

rescission of the remedial orders pending any appeal of the PTAB's decision. *Id.* at 10-11.

Arista cites as controlling authority *SSIH Equipment S.A. v. USITC*, 718 F.2d 365, 369-70 (Fed. Cir. 1983) (“*SSIH Equip.*”) where the U.S. Court of Appeals for the Federal Circuit (“Federal Circuit”) affirmed a Commission decision to modify its exclusion order to remove two patents after learning that a district court had invalidated those patents. *Id.* Arista also cites as guidance *Certain Composite Wear Components and Welding Products Containing Same*, Inv. No. 337-TA-644 (“*Composite Wear*”), where the Commission temporarily rescinded its orders based on a district court finding of invalidity. *Id.* at 13. Arista also relies on the Commission's decision in *Certain Three-Dimensional Cinema Systems and Components Thereof*, Inv. No. 337-TA-939 (“*Three-Dimensional Cinema*”), in which the Commission suspended enforcement of the remedial orders as to claims found unpatentable by the PTAB pending final resolution of the PTAB's Final Written Decision” finding those claims unpatentable.¹⁴ *Id.* at 12-13. Although not asking for a stay of the Commission's orders, Arista argues that the public interest supports suspending or temporarily rescinding the remedial orders and that the equities weigh strongly in favor of suspension or rescission. *Id.* at 14-16. Arista also argues that enforcing invalidated patents would unfairly harm Arista and its customers. *Id.* at 16-17.

Cisco argues that Arista cannot satisfy the statutory standards for rescission of the orders because it is not true that the conditions that led to the remedial orders “no longer exist.” Cisco Resp. at 9-13. Specifically, Cisco asserts that the PTAB decisions have no binding or collateral estoppel effect on the Commission and do not require the Commission to suspend or revoke its

¹⁴ The *Composite Wear* and *Three-Dimensional Cinema* Commission decisions were not appealed.

PUBLIC VERSION

remedial orders. *Id.* at 9. Cisco contends that claims can be cancelled only after the time for appeal has expired or any appeal has terminated, citing *inter alia*, 35 U.S.C. § 318(b) and *Fresenius USA, Inc. v. Baxter Int'l, Inc.*, 721 F.3d 1330, 1344 (Fed. Cir. 2013) (“*Fresenius*”). *Id.* Cisco discounts Arista’s reliance on cases in which the Commission modified its relief after a district court invalidated patent claims, noting that district court findings of invalidity have immediate collateral effects unless reversed on appeal. *Id.* at 11. Cisco also attacks the merits of the PTAB’s decisions and argues that they are likely to be reversed on appeal. *Id.* at 13-24. According to Cisco, the equities strongly favor denying Arista’s request, pointing to the fact that the ‘577 patent will expire within the year and that the Commission’s investigation took 29 months to complete. *Id.* at 24-29.

In OUII’s view, the petitions present close questions, but it submits that Commission precedent and consideration of the equities support suspension of the remedial orders pending appeal of the PTAB decisions. OUII Resp. at 1.

IV. DISCUSSION

A. The Requirements of 19 U.S.C. § 1337(k) and 19 C.F.R. 210.76(a) and Legal Precedents

Under Section 337(k) and Commission rule 210.76(a), the Commission must determine whether there are, in fact, changed circumstances that warrant temporarily rescinding the remedial orders issued in this investigation as requested by Arista.¹⁵ For the reasons below, the

¹⁵ There is no provision in the statute for suspending remedial orders subsequent to their issuance. The suspension in *Three Dimensional Cinema* occurred prior to the Commission’s final determination and issuance of remedial orders and was rendered as an exercise of the Commission’s discretion. Thus, we will discuss Arista’s petitions only in terms of a “temporary rescission” consistent with the Commission’s action in *Certain Composite Wear Components*

PUBLIC VERSION

Commission finds that the PTAB final written decisions do not constitute changed conditions of fact or law that warrant temporary rescission of the remedial orders pending appeal of the PTAB decisions.

Arista asserts that “[r]emedial orders may be terminated when the Commission determines that the conditions that led to such exclusion ‘no longer exist[,]’” pursuant to section 337(k)(1). Arista’s Second Pet. at 8. Arista argues that the PTAB’s final written decisions finding unpatentable the claims of the ’577 and ’688 patents that underlie the Commission’s remedial orders constitute changed conditions under section 337(k)(1). *Id.* at 10. Arista points out that, while the “Commission plainly has the authority to bar importation ‘of articles that infringe a *valid and enforceable* United States patent[,]” the Commission “lacks authority to issue orders barring the importation of products that practice *invalid* patents.” *Id.* at 8 (emphasis in original) (citing 19 U.S.C. § 1337(a)(1)(B)).

The America Invents Act (“AIA”) introduced IPR as a trial proceeding conducted at the PTAB to review the patentability of one or more claims in a patent on certain limited grounds. 35 U.S.C. §§ 311-319. The PTAB may institute an IPR proceeding upon a showing that there is a reasonable likelihood that at least one of the challenged claims is unpatentable. 37 C.F.R. § 42.108(c). If the IPR proceeding is instituted and not later dismissed, the PTAB will issue a final written decision with respect to the patentability of any patent claim challenged by the petitioner and any new claim added during the proceeding. 35 U.S.C. § 318(a). Appeals of PTAB final decisions are exclusively to the Federal Circuit. 35 U.S.C. § 141(c).

and Welding Products Containing Same, Inv. No. 337-TA-644.

PUBLIC VERSION

The scheme of IPR proceedings is similar to that of the earlier patent reexamination practice in that a patent claim that has been subject to IPR or reexamination is valid until the PTO issues a certificate of cancellation as to that claim following the exhaustion of all possible appeals. Specifically, the statute implementing IPR proceedings states as follows:

If the Patent Trial and Appeal Board issues a final written decision under subsection (a) *and the time for appeal has expired or any appeal has terminated*, the Director shall issue and publish a certificate canceling any claim of the patent finally determined to be unpatentable, confirming any claim of the patent determined to be patentable, and incorporating in the patent by operation of the certificate any new or amended claim determined to be patentable.

35 U.S.C. §§ 318(b) (emphasis added); *compare* 35 U.S.C. § 307(a).¹⁶ In an appeal of a PTO reexamination proceeding governed by 35 U.S.C. § 307, the Federal Circuit explained the binding effect of a final, affirmed PTO decision determining invalidity:

[T]here is no basis for distinguishing between the effects of a final, affirmed court decision determining invalidity and a *final, affirmed PTO decision* determining invalidity on a pending litigation. The latter is binding not because of collateral estoppel, but because Congress has expressly delegated reexamination authority to the PTO under a statute requiring the PTO to cancel rejected claims, and *cancellation extinguishes the underlying basis for suits based on the patent*.

Fresenius, 721 F.3d at 1344 (emphasis added).

¹⁶ 35 U.S.C. § 307(a), which is applicable in reexamination proceedings, states as follows:

In a reexamination proceeding under this chapter, when the time for appeal has expired or any appeal proceeding has terminated, the Director will issue and publish a certificate canceling any claim of the patent finally determined to be unpatentable, confirming any claim of the patent determined to be patentable, and incorporating in the patent any proposed amended or new claim determined to be patentable.

PUBLIC VERSION

By contrast, the Federal Circuit has explained that a finding of invalidity by a federal district court has immediate preclusive effects upon the continued vitality of Commission remedial orders. *See SSIH Equip. S.A. v. Int'l Trade Comm'n*, 718 F.2d 365, 370 (Fed. Cir. 1983) (“Moreover, the law is well settled that the pendency of an appeal has no [e]ffect on the finality or binding effect of a trial court’s holding. That rule is applicable to holdings of patent invalidity as well.”) (internal citations omitted); *see also Blonder-Tongue Laboratories, Inc. v. University of Illinois Foundation*, 402 U.S. 313 (1971).

Based on the above-noted statutory provisions and case law, the Commission finds that the PTAB final written decisions finding the relevant claims of the '577 and '668 patents unpatentable do not constitute a changed circumstance warranting temporarily rescinding the remedial orders issued in Inv. No. 337-TA-945, *Certain Network Devices (II)*. Contrary to Arista’s assertion that the relevant claims are invalid and, thus, that the Commission lacks authority to maintain the remedial orders, the law is clear that patent claims are valid until the PTO issues certificates cancelling for those claims, which it cannot do until the exhaustion of any appeals Cisco may take from the PTAB’s final written decisions.¹⁷ Arista may seek redress from the Commission pursuant to section 337(k) and Commission Rule 210.76 if and when the certificates of cancellation of the subject patent claims are issued.

Arista asserts that “controlling Federal Circuit authority” requires temporarily rescinding

¹⁷ Cisco indicates that it intends to appeal the PTAB’s final written decisions on an expedited basis. Cisco Resp. at 4 (“Cisco will consent to expedited appeals of the PTAB decisions”), 8 (“Cisco has a right to appeal the PTAB decisions to the Federal Circuit Cisco believes that the PTAB decisions here contain significant errors that warrant reversal, and the Commission should not suspend, rescind, or otherwise stay its remedial orders pending such appeals.”).

PUBLIC VERSION

the Commission's remedial orders. Arista's Second Pet. at 10-12. In particular, Arista relies on *SSIH Equip.*, in which the Federal Circuit approved the Commission's decision to modify its exclusion order *sua sponte* following a district court decision invalidating two of the patents that formed a basis for the Commission's order. *Id.* (citing *SSIH Equip.*, 718 F.2d at 369-70). In contrast to *SSIH Equip.*, which concerns a finding of invalidity by a district court, the instant situation concerns a PTAB final written decision, which, as noted above, has no collateral estoppel effect on the Commission proceeding. Similarly, Arista's reliance on a Commission decision to temporarily rescind remedial orders following a finding of invalidity of the relevant patent by a district court is also unavailing. *See id.* at 13 (citing *Composite Wear*, Comm'n Op. at 9).

Arista further relies on the Commission's decision in *Three-Dimensional Cinema*, in which the Commission determined to "suspend enforcement of the remedial orders as to the asserted claims of one underlying patent pending final resolution of the PTAB's Final Written Decision" finding those claims unpatentable. *Id.* at 12 (citing *Three-Dimensional Cinema*, Comm'n Op. at 60-61). There are, however, important distinctions between the situations in *Three-Dimensional Cinema* and this investigation. Most importantly, in *Three-Dimensional Cinema*, the Commission had not yet issued remedial orders when it "exercise[d] its discretion and suspend[ed] enforcement of the remedial orders as to the asserted claims of the '934 patent pending final resolution of the PTAB's Final Written Decision." *Three-Dimensional Cinema*, Comm'n Op. at 60. The Commission has broad discretion in selecting the form, scope, and extent of the remedy. *Viscofan, S.A. v. Int'l Trade Comm'n*, 787 F.2d 544, 548 (Fed. Cir. 1986). Moreover, the *Three-Dimensional Cinema* orders were not totally suspended because they were

PUBLIC VERSION

also based on other patent claims that were not found invalid by the PTAB and that covered the same accused products.¹⁸ *Id.*, Comm’n Op. at 60. In contrast, the Commission has already issued the remedial orders in *Network Devices (II)* and those orders “shall continue in effect until the Commission finds . . . that the conditions which led to such exclusion . . . no longer exist.” 19 U.S.C § 1337(k)(1).

Based on the preceding discussion, the Commission finds that Arista has failed to show that the PTAB’s issuance of final written decisions finding unpatentable the relevant claims of the ’577 and ’668 patents constitute changed circumstances under section 337(k).

B. The Public Interest and Equities

Although the Commission finds that a decision on whether to temporarily rescind remedial orders under section 337(k) is a statutory question, we note that the parties have devoted considerable efforts to briefing the consideration of the public interest or equities.

Arista argues that maintaining the remedial orders would harm the public interest. Arista’s Second Pet. at 14. Specifically, Arista contends that “maintaining the remedial orders despite the invalidity findings would run counter to the policy of eliminating bad patents that hinder competition.” *Id.* at 14-15 (citing, *e.g.*, *SmithKline Beecham Corp. v. Apotex Corp.*, 403 F.3d 1331, 1354 (Fed. Cir. 2005) (“[T]he Supreme Court ha[s] recognized that there is a significant public policy interest in removing invalid patents from the public arena”)). Arista further argues that “maintaining the remedial orders would [

] and would also “cause

¹⁸ Although supporting Arista’s petition, OUII likewise notes this distinction between the present case and *Three-Dimensional Cinema*. OUII Resp. at 5-6.

PUBLIC VERSION

[.]” *Id.* at 15.

Arista asserts that, although it “is [.] for the ’577 patent, doing so will [

] Arista’s First Pet. at 7. In particular, Arista asserts that [

] and would require them to [

] *Id.* at 7-8. Similarly, regarding

the ’668 patent, Arista contends that [.] “would be

[.] Arista’s Second

Pet. at 6.

The Commission engaged in a careful evaluation of the section 337 public interest factors before issuing the *Network Devices (II)* remedial orders, including considering the effect of the orders on consumers and competitive conditions in the United States. *See* Comm’n Op. at 130-36; 19 U.S.C. §§ 1337(d)(1), (f)(1). The Commission found that

the evidence presented by Cisco shows that there are numerous alternative networking technologies, including those supplied by Cisco and others in the industry . . . [and] that Cisco has the resources and supply chain to scale production to meet any increase in demand. The evidence also indicates that there would be no harm to competitive conditions if Arista’s products were excluded.

Id. at 134. The only change in the facts previously before the Commission is that the PTAB has found the relevant claims of the ’557 and ’668 patents unpatentable in final written decisions.

As discussed above, however, absent a certificate of cancellation regarding those claims, there has been no change in the legal status of those patent claims. Thus, Arista has failed to

PUBLIC VERSION

demonstrate any change in circumstances that would warrant revisiting the Commission’s prior determination concerning the public interest.

Arista further contends that, while it “would [] if the remedial orders are maintained despite the ’577 and ’668 patents having been found invalid[,]” any harm to Cisco would be negligible. Arista’s Second Pet. at 16. Specifically, Arista notes that Cisco “has done nothing to stop [] found to infringe the ’577 patent [] *Id.* at 18. Moreover, Arista asserts, “Cisco has also done nothing to stop the widespread use of the accused technology of the ’668 patent by other vendors in the market.” *Id.* Nor, Arista contends, did Cisco “stop Arista from allegedly using the technology claimed in the ’577 and ’668 patents for many years.” *Id.*

Arista presented many of these same arguments to the ALJ in alleging equitable estoppel, laches, and unclean hands. The Final ID finds that Arista failed to prove the applicability of any of these defenses. Final ID at 263-271, 273-277. Arista did not petition for review of any of the final ID’s findings on those points, and they became the final determinations of the Commission. The Commission declines to entertain Arista’s attempt to resurrect those arguments now.

Arista also asserts that there would be no harm to Cisco in temporarily rescinding the remedial orders because “Cisco will be able to seek a full recovery for any possible harm it might endure in the interim,” noting in particular the presently stayed action in the Northern District of California. Arista’s Second Pet. at 18. As the Commission has explained, however, the possibility of a complainant receiving monetary damages for the same behavior that entitles it

PUBLIC VERSION

to a Commission exclusion order does not warrant denying the complainant of the unique remedy available from the Commission. *See Certain Semiconductor Chips with Minimized Chip Package Size*, Inv. No. 337-TA-605 (“*Semiconductor Chips*”), Comm’n Op., 2009 WL 2350644, at *5 (July 29, 2009) (“The statute provides, however, that the remedies available for violation of Section 337 are ‘in addition to any other provision of law’ 19 U.S.C. § 1337(a)(1). Therefore, we reject Respondents’ contention that money damages will make up for the loss of Section 337 relief.”).

We also note Cisco’s argument that, because “the ’577 patent is only a year away from expiration . . . Arista’s so-called temporary relief would effectively be permanent.” Cisco Resp. at 26.¹⁹ Cisco argues that the “unfairness to Cisco in this proceeding [if rescission is granted] is greatly magnified because there were [] multiple delays in issuing an ID, resulting in an investigation that took approximately 29 months to complete.” Cisco Resp. at 27. The Commission has considered the length of the remaining patent term as a factor in deciding whether to stay enforcement of its remedial orders in *Semiconductor Chips*, where a patent examiner’s decision during a reexamination proceeding before the PTO found the relevant patent claims unpatentable. The Commission rejected the request to stay enforcement of its orders, in part, because the patent had a limited time remaining (approximately 14 months) and the “full

¹⁹ Although OUII supports Arista’s petition, it acknowledges that “suspension of the remedial orders would prevent Cisco from obtaining relief on patents that will only be cancelled upon completion of the (potentially long) appellate process, and there is a strong public interest in the enforcement of intellectual property rights.” OUII Resp. at 7 (citing *Certain Gaming and Entertainment Consoles, Related Software, and Components Thereof*, Inv. 337-TA-752, Recommended Determination on Remedy and Bonding, 2012 WL 1881021, at *2 (May 7, 2012)).

PUBLIC VERSION

examination process, including appeals, will take at least the remaining terms of the patents.”
Inv. No. 337-TA-605, Comm’n Op., 2009 WL 2350644, at *3.

C. Likelihood of the PTAB’s Final Written Decision Surviving Appeal

Arista and Cisco make extensive arguments concerning the soundness of the PTAB’s decisions and the likelihood that they will be affirmed on appeal. These arguments, however, have no bearing on the Commission’s decision. Given the vast differences between the administrative records in the Commission and PTAB proceeding, and the differing burdens (invalidity may be proved by a preponderance of the evidence in PTAB decision), the Commission declines to consider Cisco’s invitations to examine the merits of the PTAB’s invalidity decisions. Cisco complains in particular about the PTAB’s decision not to apply assignor estoppel.²⁰ However, Cisco has not shown that it is within the Commission’s purview to comment on another agency’s interpretation of its organic statute.

Although both Arista and Cisco make various references to the traditional stay factors throughout their briefing, Arista has not specifically requested a stay of the remedial orders. The traditional four-prong test for determining whether a stay is warranted includes: (1) likelihood of success on the merits, (2) irreparable harm to the movant in the absence of a stay, (3) balance of harms, and (4) consideration of the public interest. *See Standard Havens Prods., Inc. v. Gencor Indus. Inc.*, 897 F.2d 511, 512 (Fed. Cir. 1990). *In Certain Agricultural Tractors Under 50 Power Take-Off Horsepower*, Inv. 337-TA-380, Comm’n Op. at 10, 13 (Public Version) (April 24, 1997), the Commission found that the first prong is satisfied if the Commission has ruled on

²⁰ Cisco also notes that the Supreme Court has taken up the issue of whether the IPR process is constitutional. *Oil States Energy Services LLC v. Greene’s Energy Group, LLC*, S. Ct. No. 16-712 (certiorari granted June 12, 2017) (“*Oil States*”). Cisco Resp. at 28.

PUBLIC VERSION

“an admittedly difficult question.” Arista makes some traditional stay arguments concerning the public interest and balance of harms, but it does not allege that it will suffer irreparable harm if the order is not rescinded, nor does it argue that the Commission’s decision to find a violation in the *Network Devices (II)* investigation involved an admittedly difficult question.

D. Cisco’s Request for Retroactive Penalties

Cisco requests, should the Commission grant Arista’s petition and temporarily rescind the remedial orders, that the Commission “preserve the enforceability and effect of the [cease and desist order (CDO)] if Cisco prevails on its appeal of the PTAB’s decision” by levying retroactively any penalties for violating the CDO that may accrue between the suspension of the CDO and when (or if) the Federal Circuit overturns the PTAB’s decision. Cisco Resp. at 29-30.²¹ Because the Commission has determined to deny Arista’s petition, this issue is moot.

V. Arista’s Request for Leave to File a Reply

As noted above, Arista filed a motion for leave to file a reply in support of its petition, with its reply attached. It asks that it be permitted to reply to arguments made in Cisco’s response submission concerning: (1) the legal effect of the PTAB decisions; (2) the merits of the PTAB decision not to apply assignor estoppel; (3) citation of the grant of certiorari in *Oil States* to consider the constitutionality of PTAB decisions; (4) the allegedly incomplete record in the PTAB concerning alleged copying; (5) Cisco’s declaration that it is highly dubious that the PTAB’s decisions will be affirmed; and (6) Cisco’s alternative request for retroactive

²¹ OUII notes that, in *Composite Wear*, the Commission “addressed the possibility of temporary relief (in the form of importation under bond) in conjunction with suspension of remedial orders” but ultimately found that the record did not support such a remedy under section 337(e). OUII Resp. at 7-8 (citing *Composite Wear*, Comm’n Op. at 9-10).

PUBLIC VERSION

enforcement of the CDOs. Arista's Mot. for Leave at 1-4. Cisco opposes the reply, arguing that Arista's request is "a transparent and unwarranted attempt to grab the last word." Cisco's Opp. to Reply at 1. OUII did not respond.

The Commission has determined to deny Arista's request for leave to file a reply because it has not shown that it could not have addressed these issues in its petitions. The only new issue raised in Cisco's response to Arista's petitions is Cisco's request for retroactive enforcement of the CDO. As discussed above, this request is moot.

VI. CONCLUSION

For the reasons discussed above, the Commission has determined to deny Arista's petitions to temporarily rescind the remedial orders issued in the *Network Devices II* investigation and also to deny Arista's motions for a shortened response time and for leave to file a reply.

By order of the Commission.



Lisa R. Barton
Secretary to the Commission

Issued: August 16, 2017

PUBLIC CERTIFICATE OF SERVICE

I, Lisa R. Barton, hereby certify that the attached **COMMISSION OPINION** has been served by hand upon the Commission Investigative Attorney, Monica Bhattacharyya, Esq., and the following parties as indicated, on **August 16, 2017**.



Lisa R. Barton, Secretary
U.S. International Trade Commission
500 E Street, SW, Room 112
Washington, DC 20436

On Behalf of Complainant Cisco Systems, Inc.:

Adam R. Alper, Esq.
KIRKLAND & ELLIS LLP
555 California Street
San Francisco, CA 94104

- Via Hand Delivery
- Via Express Delivery
- Via First Class Mail
- Other: _____

On Behalf of Respondent Arista Networks, Inc.:

Bert C. Reiser, Esq.
LATHAM & WATKINS LLP
555 Eleventh Street, NW, Suite 1000
Washington, DC 20004

- Via Hand Delivery
- Via Express Delivery
- Via First Class Mail
- Other: _____

UNITED STATES INTERNATIONAL TRADE COMMISSION
Washington, D.C.

In the Matter of

**CERTAIN NETWORK DEVICES,
RELATED SOFTWARE AND
COMPONENTS THEREOF (II)**

Investigation No. 337-TA-945

**NOTICE OF COMMISSION DECISION TO REVIEW IN PART A FINAL INITIAL
DETERMINATION FINDING A VIOLATION OF SECTION 337;
REQUEST FOR WRITTEN SUBMISSIONS**

AGENCY: U.S. International Trade Commission.

ACTION: Notice.

SUMMARY: Notice is hereby given that the U.S. International Trade Commission has determined to review in part the presiding administrative law judge's ("ALJ") final initial determination ("Final ID") issued on December 9, 2016, finding a violation of section 337 of the Tariff Act of 1930, as amended, 19 U.S.C. § 1337 ("section 337") in the above-captioned investigation.

FOR FURTHER INFORMATION CONTACT: Megan M. Valentine, Office of the General Counsel, U.S. International Trade Commission, 500 E Street, S.W., Washington, D.C. 20436, telephone (202) 708-2301. Copies of non-confidential documents filed in connection with this investigation are or will be available for inspection during official business hours (8:45 a.m. to 5:15 p.m.) in the Office of the Secretary, U.S. International Trade Commission, 500 E Street, S.W., Washington, D.C. 20436, telephone (202) 205-2000. General information concerning the Commission may also be obtained by accessing its Internet server at <https://www.usitc.gov>. The public record for this investigation may be viewed on the Commission's electronic docket (EDIS) at <https://edis.usitc.gov>. Hearing-impaired persons are advised that information on this matter can be obtained by contacting the Commission's TDD terminal on (202) 205-1810.

SUPPLEMENTARY INFORMATION: The Commission instituted this investigation on January 27, 2015, based on a Complaint filed by Cisco Systems, Inc. of San Jose, California ("Cisco"). 80 FR 4313-14 (Jan. 27, 2015). The Complaint alleges violations of section 337 of the Tariff Act of 1930, as amended, 19 U.S.C. § 1337, in the sale for importation, importation, and sale within the United States after importation of certain network devices, related software and components thereof by reason of infringement of certain claims of U.S. Patent Nos. 7,023,853; 6,377,577; 7,460,492; 7,061,875; 7,224,668; and 8,051,211. The Complaint further alleges the existence of a domestic industry. The Commission's Notice of Investigation named Arista Networks, Inc. of Santa Clara, California ("Arista") as respondent. The Office of Unfair Import Investigations ("OUII") was also named as a party to the investigation. The Commission previously terminated the investigation in part as to certain claims of the asserted patents. Order

No. 38 (Oct. 27, 2015), unreviewed Notice (Nov. 18, 2015); Order No. 47 (Nov. 9, 2015), unreviewed Notice (Dec. 1, 2015).

On December 9, 2016, the ALJ issued her Final ID, finding a violation of section 337 with respect to claims 1, 7, 9, 10, and 15 of the '577 patent; and claims 1, 2, 4, 5, 7, 8, 10, 13, 18, 56, and 64 of the '668 patent. The ALJ found no violation of section 337 with respect to claim 2 of the '577 patent; claims 46 and 63 of the '853 patent; claims 1, 3, and 4 of the '492 patent; claims 1-4, and 10 of the '875 patent; and claims 2, 6, 13, and 17 of the '211 patent.

In particular, the Final ID finds that Cisco has shown by a preponderance of the evidence that the accused products infringe asserted claims 1, 7, 9, 10, and 15 of the '577 patent; and asserted claims 1, 2, 4, 5, 7, 8, 10, 13, 18, 56, and 64 of the '668 patent. The Final ID finds that Cisco has failed to show by a preponderance of the evidence that the accused products infringe asserted claim 2 of the '577 patent; asserted claims 46 and 63 of the '853 patent; asserted claims 1, 3, and 4 of the '492 patent; asserted claims 1-4, and 10 of the '875 patent; and asserted claims 2, 6, 13, and 17 of the '211 patent.

The Final ID also finds that assignor estoppel bars Arista from asserting that the '577 and '853 patents are invalid. The Final ID finds, however, that if assignor estoppel did not apply, Arista has shown by clear and convincing evidence that claims 1, 7, 9, 10, and 15 of the '577 patent and claim 46 of the '853 patent are invalid as anticipated by U.S. Patent No. 5,920,886 ("Feldmeier"). The Final ID further finds that Arista has failed to show by clear and convincing evidence that any of the remaining asserted claims are invalid. The Final ID also finds that Arista has not proven by clear and convincing evidence that Cisco's patent claims are barred by equitable estoppel, waiver, implied license, laches, unclean hands, or patent misuse.

The Final ID finds that Cisco has satisfied the economic prong of the domestic industry requirement for all of the patents-in-suit pursuant to 19 U.S.C. § 337(A), (B), and (C). The Final ID finds, however, that Cisco has failed to satisfy the technical prong of the domestic industry requirement with respect to the '875, '492, and '211 patents. The Final ID finds that Cisco has satisfied the technical prong with respect to the '577, '853, and '668 patents.

The Final ID also contains the ALJ's recommended determination on remedy and bonding. The ALJ recommended that the appropriate remedy is a limited exclusion order with a certification provision and a cease and desist order against Arista. The ALJ recommended the imposition of a bond of 5% during the period of Presidential review.

On December 29, 2016, Cisco, Arista, and OUII each filed petitions for review of various aspects of the Final ID. As described below, some of the issues presented for review were in the form of contingent petitions.

Cisco petitions for review of the Final ID's construction of certain limitations recited in claim 46 of the '853 patent and the resulting finding that Arista's accused products do not infringe that claim. Cisco also petitions for review of the Final ID's findings of non-infringement and non-satisfaction of the technical prong of the domestic industry requirement with respect to the '875, '492, and '211 patents. Cisco requests contingent review of the Final

ID's finding that Arista does not indirectly infringe the asserted claims of the '577 patent should the Commission review the Final ID's finding that Arista's post-importation direct infringement cannot alone support a finding of violation of section 337. Cisco also requests contingent review of the Final ID's finding that Feldmeier anticipates the asserted claims of the '577 patent should the Commission review the Final ID's finding that assignor estoppel applies.

Arista petitions for review of the Final ID's construction of certain limitations recited in the asserted claims of the '577 and '668 patents and the resulting finding that certain of Arista's accused products infringe those claims. Arista also petitions for review of the Final ID's findings of indirect infringement with respect to the '577 and '668 patents. Arista further petitions for review of the Final ID's finding that assignor estoppel precludes Arista from challenging the validity of the '577 and '853 patents. Arista requests contingent review of the Final ID's finding that claim 46 of the '853 patent is invalid as anticipated and indefinite should the Commission review the ALJ's non-infringement findings with respect to that claim. Arista also requests contingent review of the issue of indirect infringement regarding the '853, '211, '875, and '492 patents should the Commission review the Final ID's findings of no direct infringement with respect to those patents.

OUII petitions for review of the Final ID's finding that the "configurable PiP CoPP" implementation in Arista's accused products infringes the asserted claims of the '668 patent. OUII also petitions for review of the Final ID's reliance on the Patent Trial and Appeal Board decision in finding that claims 1 and 12 of the '211 patent are invalid as anticipated. OUII requests contingent review of the Final ID's finding that Feldmeier anticipates the asserted claims of the '577 patent should the Commission review the Final ID's finding that assignor estoppel applies. OUII further requests contingent review of the Final ID's construction of certain means-plus-functions claims recited in claim 46 of the '853 patent should the Commission review the Final ID's finding that the accused products do not infringe that claim.

On January 10, 2017, Cisco, Arista, and OUII filed responses to the various petitions for review.

On January 11, 2017, Cisco and Arista each filed a post-RD statement on the public interest pursuant to Commission Rule 210.50(a)(4). No responses were filed by the public in response to the post-RD Commission Notice issued on December 20, 2016. *See* Notice of Request for Statements on the Public Interest (Dec. 20, 2016); 81 FR 95194-95 (Dec. 27, 2016).

Having examined the record of this investigation, including the Final ID, the petitions for review, and the responses thereto, the Commission has determined to review the Final ID in part.

With respect to the '577 patent, the Commission has determined to review the Final ID's finding that Arista has indirectly infringed the '577 patent by importing Imported Components, as referenced at page 110 in the Final ID. The Commission has also determined to review the Final ID's finding that Arista's post-importation direct infringement cannot alone support a finding of violation of section 337. The Commission has further determined to review the Final ID's finding that Feldmeier anticipates claims 1, 7, 9, 10, and 15 of the '577 patent.

With respect to the '853 patent, the Commission has determined to review the Final ID's claim construction findings with respect to claim elements (c), (d), and (f) of claim 46. The Commission has also determined to review the Final ID's findings concerning direct and indirect infringement regarding the '853 patent. The Commission has further determined to review the Final ID's finding that assignor estoppel applies to validity challenges based on indefiniteness. The Commission has also determined to review the Final ID's finding that Feldmeier does not anticipate claim 46.

With respect to the '875 and '492 patents, the Commission has determined to review the Final ID's finding of no direct infringement and the related finding of no indirect infringement. The Commission has also determined to review the Final ID's finding that Cisco has failed to satisfy the technical prong of the domestic industry requirement with respect to the '875 and '492 patents.

With respect to the '668 patent, the Commission has determined to review the Final ID's finding of direct infringement and the Final ID's finding of indirect infringement, in particular as concerns Arista's importation of Imported Components.

With respect to the '211 patent, the Commission has determined to review the Final ID's finding that Cisco has failed to satisfy the technical prong with respect to claims 1 and 12 of the '211 patent, including the Final ID's finding that claims 1 and 12 are invalid.

The Commission has determined not to review the remaining issues decided in the Final ID.

The parties are requested to brief their positions on the issues under review with reference to the applicable law and the evidentiary record. In connection with its review, the Commission is particularly interested in responses to the following questions:

1. Discuss the relevant case law regarding the requirement, pursuant to 35 U.S.C. § 271(c), that to be found liable for contributory infringement, the accused infringer must import into the United States or sell within the United State a device that constitutes a "material part of the invention." In addition, please address whether the Imported Components satisfy this requirement with respect to the '577, '853, and '668 patents. Please cite to and discuss any relevant evidence in the record.
2. Please address whether the Accused ACL Products infringe asserted claim 46 of the '853 patent if the 35 U.S.C. § 112, ¶ 6 (means-plus-function) limitation "means for matching matchable information, said matchable information being responsive to said packet label, with said set of access control patterns in parallel" is construed to require as the corresponding structure an access control memory, including one or more content-addressable memory units of the type shown in Figure 2 of the '853 patent.

3. Please address whether the Accused ACL Products infringe asserted claim 46 of the '853 patent if the 35 U.S.C. § 112, ¶ 6 (means-plus-function) limitation “means for generating a set of matches in response thereto, each said match having priority information associated therewith” is construed to require as the corresponding structure an access control memory, including one or more content-addressable memory units of the type shown in Figure 2 of the '853 patent.
4. Please address whether the Accused ACL Products with the Petra chip infringe asserted claim 46 of the '853 patent, in particular with respect to the 35 U.S.C. § 112, ¶ 6 (means-plus-function) limitation “means for selecting at least one of said matches in response to said priority information, and generating an access result in response to said at least one selected match.”
5. Regarding the 35 U.S.C. § 112, ¶ 6 (means-plus-function) limitation “means for making a routing decision in response to said access result” recited in asserted claim 46 of the '853 patent, please address whether any corresponding structure disclosed in the specification of the '853 patent satisfies the claimed function, other than the structure recited in the Final ID's claim construction or the structures previously proposed by the parties.
6. With reference to question five, please address whether the Accused ACL Products infringe claim 46 of the '853 patent under the proper construction of the 35 U.S.C. § 112, ¶ 6 (means-plus-function) limitation “means for making a routing decision in response to said access result.”
7. Please address whether the Accused Loop Guard Products and the DI Loop Guard Products practice the limitation “including a discarding state” recited in claims 1 and 10 of the '875 patent and/or the limitation “including a discarding port state” recited in claim 1 of the '492 patent under the ALJ's claim construction of “discarding [port] state,” which requires “a port state in a spanning tree protocol or algorithm in which data frames are neither forwarded to nor received from the port.” Please cite to and discuss any relevant evidence in the record.
8. Please address whether the Accused Loop Guard Products and the DI Loop Guard Products practice the limitation “including . . . a listening state” recited in claims 1 and 10 of the '875 patent and/or the limitation “including . . . a listening [port] state” recited in claim 1 of the '492 patent. In particular, please discuss the disclosure in exhibit CX-0653 at pages 63, 66, and 67. In addition, please cite to and discuss any other relevant evidence in the record.
9. With respect to the '668 patent, please address whether the Pip CoPP feature in the '668 Accused Products is a physical port service. In particular, please address the significance of the ALJ's finding on page 196 of the Final ID. In addition, please cite to and discuss any relevant evidence in the record.

The parties have been invited to brief only these discrete issues, as enumerated above, with reference to the applicable law and evidentiary record. The parties are not to brief other issues on review, which are adequately presented in the parties' existing filings.

In connection with the final disposition of this investigation, the Commission may (1) issue an order that could result in the exclusion of the subject articles from entry into the United States, and/or (2) issue one or more cease and desist orders that could result in the respondent(s) being required to cease and desist from engaging in unfair acts in the importation and sale of such articles. Accordingly, the Commission is interested in receiving written submissions that address the form of remedy, if any, that should be ordered. If a party seeks exclusion of an article from entry into the United States for purposes other than entry for consumption, the party should so indicate and provide information establishing that activities involving other types of entry either are adversely affecting it or likely to do so. For background, see *Certain Devices for Connecting Computers via Telephone Lines*, Inv. No. 337-TA-360, USITC Pub. No. 2843 (December 1994) (Commission Opinion).

If the Commission contemplates some form of remedy, it must consider the effects of that remedy upon the public interest. The factors the Commission will consider include the effect that an exclusion order and/or cease and desist orders would have on (1) the public health and welfare, (2) competitive conditions in the U.S. economy, (3) U.S. production of articles that are like or directly competitive with those that are subject to investigation, and (4) U.S. consumers. The Commission is therefore interested in receiving written submissions that address the aforementioned public interest factors in the context of this investigation.

If the Commission orders some form of remedy, the U.S. Trade Representative, as delegated by the President, has 60 days to approve or disapprove the Commission's action. See Presidential Memorandum of July 21, 2005, 70 FR 43251 (July 26, 2005). During this period, the subject articles would be entitled to enter the United States under bond, in an amount determined by the Commission and prescribed by the Secretary of the Treasury. The Commission is therefore interested in receiving submissions concerning the amount of the bond that should be imposed if a remedy is ordered.

WRITTEN SUBMISSIONS: The parties to the investigation, including the Office of Unfair Import Investigations, are requested to file written submissions on the issues identified in this notice. Parties to the investigation, including the Office of Unfair Import Investigations, interested government agencies, and any other interested parties are encouraged to file written submissions on the issues of remedy, the public interest, and bonding. Such submissions should address the recommended determination by the ALJ on remedy and bonding. Complainant and the Office of Unfair Import Investigations are also requested to submit proposed remedial orders for the Commission's consideration. Complainant is further requested to state the dates that the patents expire, the HTSUS numbers under which the accused products are imported, and any known importers of the accused products. The written submissions and proposed remedial orders must be filed no later than close of business on **March 15, 2017**. Initial submissions are limited to 50 pages, not including any attachments or exhibits related to discussion of the public interest. Reply submissions must be filed no later than the close of business on **March 24, 2017**. Reply submissions are limited to 25 pages, not including any attachments or exhibits related to

discussion of remedy, the public interest, and bonding. No further submissions on these issues will be permitted unless otherwise ordered by the Commission.

Persons filing written submissions must file the original document electronically on or before the deadlines stated above and submit 8 true paper copies to the Office of the Secretary by noon the next day pursuant to section 210.4(f) of the Commission's Rules of Practice and Procedure (19 C.F.R. 210.4(f)). Submissions should refer to the investigation number ("Inv. No. 337-TA-945") in a prominent place on the cover page and/or the first page. (*See Handbook for Electronic Filing Procedures*, https://www.usitc.gov/documents/handbook_on_filing_procedures.pdf). Persons with questions regarding filing should contact the Secretary (202-205-2000).

Any person desiring to submit a document to the Commission in confidence must request confidential treatment. All such requests should be directed to the Secretary to the Commission and must include a full statement of the reasons why the Commission should grant such treatment. *See* 19 CFR 201.6. Documents for which confidential treatment by the Commission is properly sought will be treated accordingly. All information, including confidential business information and documents for which confidential treatment is properly sought, submitted to the Commission for purposes of this Investigation may be disclosed to and used: (i) by the Commission, its employees and Offices, and contract personnel (a) for developing or maintaining the records of this or a related proceeding, or (b) in internal investigations, audits, reviews, and evaluations relating to the programs, personnel, and operations of the Commission including under 5 U.S.C. Appendix 3; or (ii) by U.S. government employees and contract personnel^[1], solely for cybersecurity purposes. All nonconfidential written submissions will be available for public inspection at the Office of the Secretary and on EDIS.

The authority for the Commission's determination is contained in section 337 of the Tariff Act of 1930, as amended (19 U.S.C. § 1337), and in Part 210 of the Commission's Rules of Practice and Procedure (19 C.F.R. Part 210).

By order of the Commission.



Lisa R. Barton
Secretary to the Commission

Issued: March 1, 2017

^[1] All contract personnel will sign appropriate nondisclosure agreements.

PUBLIC CERTIFICATE OF SERVICE

I, Lisa R. Barton, hereby certify that the attached **NOTICE** has been served by hand upon the Commission Investigative Attorney, Monica Bhattacharyya, Esq., and the following parties as indicated, on **March 1, 2017**.



Lisa R. Barton, Secretary
U.S. International Trade Commission
500 E Street, SW, Room 112
Washington, DC 20436

On Behalf of Complainant Cisco Systems, Inc.:

Adam R. Alper, Esq.
KIRKLAND & ELLIS LLP
555 California Street
San Francisco, CA 94104

- Via Hand Delivery
 Via Express Delivery
 Via First Class Mail
 Other: _____

On Behalf of Respondent Arista Networks, Inc.:

Bert C. Reiser, Esq.
LATHAM & WATKINS LLP
555 Eleventh Street, NW, Suite 1000
Washington, DC 20004

- Via Hand Delivery
 Via Express Delivery
 Via First Class Mail
 Other: _____

UNITED STATES INTERNATIONAL TRADE COMMISSION

Washington, D.C.

In the Matter of

**CERTAIN NETWORK DEVICES,
RELATED SOFTWARE AND
COMPONENTS THEREOF (II)**

Inv. No. 337-TA-945

**INITIAL DETERMINATION ON VIOLATION OF SECTION 337 AND
RECOMMENDED DETERMINATION ON REMEDY AND BOND**

Administrative Law Judge MaryJoan McNamara

(December 9, 2016)

Appearances:

For the Complainant Cisco Systems, Inc.:

Steven Cherny, Esq., James E. Marina, Esq., and Brian Paul Gearing, Esq. of Kirkland & Ellis LLP, New York, N.Y.

Adam R. Alper, Esq., Sarah E. Piepmeier, Esq., and Brandon H. Brown, Esq. of Kirkland & Ellis LLP, San Francisco, C.A.

Michael W. De Vries, Esq. and Nimalka R. Wickramasekera, Esq. of Kirkland & Ellis LLP, Los Angeles, C.A.

D. Sean Trainor, Esq. of Kirkland & Ellis LLP, Washington, D.C.

Lien Dang, Esq. and Eric Cheng, Esq. of Kirkland & Ellis LLP, Palo Alto, C.A.

For the Respondents Arista Networks, Inc.:

Ruffin B. Cordell, Esq., Michael J. McKeon, Esq., Lauren A. Degnan, Esq., Ralph A. Phillips, Esq., Richard A. Sterba, Esq., and Thomas S. Fusco, Esq. of Fish & Richardson P.C., Washington, D.C.

For the Commission Investigative Staff:

Margaret D. Macdonald, Esq., Director; Jeffrey T. Hsu, Esq., Supervisory Attorney; and Monica Bhattacharyya, Esq., Investigative Attorney, of the Office of Unfair Import Investigations, U.S. International Trade Commission, Washington, D.C.

Public Version

SUMMARY OF FINDINGS

Pursuant to the Notice of Investigation, 80 Fed. Reg. 4313 (January 27, 2015), this is the Initial Determination of the Investigation in the Matter of Certain Network Devices, Related Software, and Components Thereof (II), United States International Trade Commission Investigation No. 337-TA-945. *See* 19 C.F.R. § 210.42(a).

It is held that a violation of Section 337 of the Tariff Act of 1930, as amended (19 U.S.C. § 1337), has occurred in the importation into the United States, the sale for importation, or the sale within the United States after importation, of certain network devices, related software, and components thereof, by reason of infringement of asserted claims 1, 7, 9, 10, and 15 of United States Patent No. 6,377,577 (“the ’577 patent”); and asserted claims 1, 2, 4, 5, 7, 8, 10, 13, 18, 56, and 64 of United States Patent No. 7,224,668 (“the ’668 patent”).

There is no violation of Section 337 of the Tariff Act of 1930, as amended (19 U.S.C. § 1337) of certain network devices, related software, and components thereof, by reason of infringement of asserted claim 2 of United States Patent No. 6,377,577; asserted claims 46 and 63 of United States Patent No. 7,023,853 (“the ’853 patent”); asserted claims 1, 3, and 4 of United States Patent No. 7,460,492 (“the ’492 patent”); asserted claims 1-4, and 10 of United States Patent No. 7,061,875 (“the ’875 patent”); and asserted claims 2, 6, 13, and 17 of United States Patent No. 8,051,211 (“the ’211 patent”).

It is held that a domestic industry exists that practices U.S. Patent Nos. 6,377,577 and 7,224,668 pursuant to 19 U.S.C. §§ 1337(a)(2) and (a)(3).

TABLE OF CONTENTS

**INITIAL DETERMINATION ON VIOLATION OF SECTION 337 AND
RECOMMENDED DETERMINATION ON REMEDY AND BOND I**

I. BACKGROUND 1

A. Institution 1

B. The Parties 2

1. Complainant Cisco Systems, Inc. 2

2. Respondent Arista Networks, Inc. 2

C. Procedural History 3

1. Generally 3

2. Motions to Strike 5

a) Cisco’s Motions to Strike 5

i. Cisco’s Motion to Strike 1 5

ii. Cisco’s Motion to Strike 2 6

iii. Cisco’s Motion to Strike 3 8

iv. Cisco’s Motion to Strike 4 9

v. Cisco’s Motion to Strike 5 11

b) Arista’s Motions to Strike 11

i. Arista’s Motion to Strike 1 11

ii. Arista’s Motion to Strike 2 13

iii. Arista’s Motion to Strike 3 14

II. JURISDICTION AND IMPORTATION 15

A. Subject Matter Jurisdiction 15

B. Personal Jurisdiction 16

C. *In Rem* Jurisdiction and Importation 17

1. Importation of the Accused Products 17

2. Importation of Hardware Components 18

D. Ownership of the Asserted Patents and Standing 19

III. THE ASSERTED PATENTS 19

A. Overview of the Technology 19

B. U.S. Patent No. 6,377,577 (“577 Patent”) 20

Public Version

1.	Overview of the '577 Patent	20
2.	The Asserted Claims	22
C.	U.S. Patent No. 7,023,853 (“’853 Patent”)	23
1.	Overview of the '853 Patent	23
2.	The Asserted Claims	23
D.	U.S. Patent No. 7,061,875 (“’875 Patent”)	25
1.	Overview of the '875 Patent	25
2.	The Asserted Claims	28
E.	U.S. Patent No. 7,460,492 (“’492 Patent”)	29
1.	Overview of the '492 Patent	29
2.	The Asserted Claims	30
F.	U.S. Patent No. 7,224,668 (“’668 Patent”)	30
1.	Overview of the '668 Patent	30
2.	The Asserted Claims	34
G.	U.S. Patent No. 8,051,211 (“’211 Patent”)	35
1.	Overview of the '211 Patent	35
2.	The Asserted Claims	38
H.	The Products at Issue.	39
IV.	RELEVANT LAW.....	40
A.	Claim Construction	40
1.	Generally	40
2.	Means-Plus-Function Claims.....	43
B.	Infringement.....	45
1.	Direct Infringement.....	45
2.	Induced Infringement.....	46
3.	Contributory Infringement.....	47
C.	Validity	49
1.	Anticipation.....	50
2.	Obviousness	51
3.	Indefiniteness	53
4.	Written Description.....	54
5.	Patent Eligibility	55

Public Version

D.	Assignor Estoppel	56
E.	Equitable Defenses.....	58
1.	Equitable Estoppel	58
2.	Waiver.....	59
3.	Implied License.....	59
4.	Laches	60
5.	Unclean Hands.....	62
6.	Patent Misuse.....	62
V.	THE '577 AND '853 PATENTS	63
A.	Level of Ordinary Skill in the Art.....	63
B.	Disputed Terms.....	63
1.	'577 Patent, Claims 1-9; '853 Patent, Claim 46—“ <i>access control patterns</i> ”	63
2.	'577 Patent, Claim 2—“ <i>performing at least two of said steps of receiving, matching, selecting, and making a routing decision, in parallel using a pipeline technique</i> ”	68
3.	'853 Patent, Claim 46—“ <i>means for maintaining a set of access control patterns in at least one associative memory</i> ”	71
4.	'853 Patent, Claim 46—“ <i>means for receiving a packet label responsible to a packet, said packet label being sufficient to perform access control processing for said packet</i> ”	75
5.	'853 Patent, Claim 46—“ <i>means for matching matchable information, said matchable information being responsive to said packet label, with said set of access control patterns in parallel</i> ”	78
6.	'853 Patent, Claim 46—“ <i>means for generating a set of matches in response thereto, each said match having priority information associated therewith</i> ”	80
7.	'853 Patent, Claim 46—“ <i>means for selecting at least one of said matches in response to said priority information, and generating an access result in response to said at least one selected match</i> ”	81
8.	'853 Patent, Claim 46—“ <i>means for making a routing decision in response to said access result</i> ”	85
C.	Infringement.....	90
1.	Accused ACL Products.....	91
2.	Claim 1 of the '577 Patent	91
a)	Strata	92

Public Version

b)	Petra	94
c)	Arad.....	95
d)	Alta.....	97
3.	Claim 2 of the '577 Patent	98
4.	Claims 7, 9-10, and 15 of the '577 Patent.....	99
5.	Claim 46 of the '853 Patent.	99
a)	“means for maintaining a set of access control patterns in at least one associative memory”	99
b)	“means for receiving a packet label responsive to a packet, said packet label being sufficient to perform access control processing for said packet”	100
c)	“means for matching matchable information, said match able information being responsive to said packet label, with said set of access control patterns in parallel”	100
d)	“means for generating a set of matches in response thereto, each said match having priority information associated therewith”	100
e)	“means for selecting at least one of said matches in response to said priority information, and generating an access result in response to said at least one selected match”	101
f)	“means for making a routing decision in response to said access result”	102
6.	Claim 63 of the '853 Patent.	103
7.	Direct Infringement by Arista.....	103
8.	Indirect Infringement	107
a)	Direct Infringement by Arista’s Customers.....	107
b)	Induced Infringement.....	108
c)	Contributory Infringement.....	109
D.	Technical Prong of Domestic Industry	113
1.	Legal Framework of the Technical Prong	114
2.	Cisco’s DI Products	115
3.	Claim 1 of the '577 Patent	115
4.	Claims 2, 7, 9-10, and 15 of the '577 Patent.....	116
5.	Claim 46 of the '853 Patent.	116

Public Version

a)	“means for maintaining a set of access control patterns in at least one associative memory”	116
b)	“means for receiving a packet label responsive to a packet, said packet label being sufficient to perform access control processing for said packet”	116
c)	“means for matching matchable information, said match able information being responsive to said packet label, with said set of access control patterns in parallel”	116
d)	“means for generating a set of matches in response thereto, each said match having priority information associated therewith”	117
e)	“means for selecting at least one of said matches in response to said priority information, and generating an access result in response to said at least one selected match”	118
f)	“means for making a routing decision in response to said access result”	119
6.	Claim 63 of the '853 Patent	120
E.	Validity	120
1.	Assignor Estoppel	120
a)	Assignment of the '577 and '853 Patents to Cisco	121
b)	Privity Between Mr. Bechtolshiem and Dr. Cheriton, and Arista	122
2.	Assignor Estoppel Applies to Arista's Defenses Based on 35 U.S.C. § 112 ¶ 2	125
3.	Anticipation	128
a)	Anticipation by Feldmeier	128
i.	Claim 1 of the '577 patent	128
ii.	Claims 7, 9-10, and 15 of the '577 patent	134
iii.	Claim 46 of the '853 patent	134
b)	Anticipation by Hendel	134
i.	Claims 1, 2, 7, 9-10, and 15 of the '577 patent	135
ii.	Claims 46 and 63 of the '853 patent	137
4.	Obviousness	137
VI.	THE '875 AND '492 PATENTS	138
A.	A Person of Ordinary Skill in the Art	138

Public Version

B.	Disputed Terms.....	138
1.	'492 Patent, Claims 3-4; '875 Patent, Claims 2-4—“ <i>loop inconsistent port state</i> ”/“ <i>loop inconsistent spanning tree port state</i> ”	138
C.	Accused Loop Guard Products	141
D.	Infringement.....	142
1.	Direct Infringement of the '875 Patent	142
a)	Claim 1.....	143
i.	“In an intermediate network device having a plurality of ports for forwarding network messages within a bridged network, a method for preventing the formation of loops within the bridged network, the method comprising the steps of”.....	143
ii.	“executing a spanning tree protocol (STP) at the intermediate network device so as to elect a root of the bridged network and to transition at least one of the device’s ports among a plurality of spanning tree port states, including a discarding state, a listening state and a forwarding state”.....	143
iii.	“periodically receiving configuration bridge protocol data unit (BPDU) messages at one or more of the device’s ports”	149
iv.	“in response to the periodic receipt of BPDU messages being stopped on a given port, (1) preventing the given port from transitioning to the forwarding spanning tree port state, if the given port is in a spanning tree port state other than the forwarding spanning tree port state, or (2) precluding the given port from forwarding or receiving network messages, if the given port is in the forwarding spanning tree port state”.....	150
v.	Conclusion	151
b)	Claims 2, 3, and 4.	151
c)	Claim 10.....	151
i.	“An intermediate network device configured to receive and forward network messages within a bridged network, the device having a plurality of ports for connecting the device to one or more network entities or other devices, the intermediate network device comprising”	151

Public Version

- ii. “a spanning tree protocol (STP) engine configured and arranged to elect a root of the bridged network and to transition at least some of the device’s ports among a plurality of spanning tree port states, including a discarding or blocking state, a listening state and a forwarding state” 152
- iii. “a loop guard engine cooperating with the STP engine, wherein configuration bridge protocol data unit (BPDU) messages are periodically received at one or more of the device’s ports” 153
- iv. “in response to the periodic receipt of BPDU messages being stopped on a given port, the loop guard engine (1) prevents the given port from transitioning to the forwarding spanning tree port state, if the given port is in a spanning tree port state other than the forwarding spanning tree port state, or (2) precludes the given port from forwarding or receiving network messages” 154
- v. Conclusion 155
- 2. Direct Infringement of the ’492 Patent 155
 - a) Claim 1 156
 - i. “An intermediate network device configured to receive and forward network messages, the intermediate network device having a plurality of ports to connect the intermediate network device to one or more other devices, the intermediate network device comprising” 156
 - ii. “one or more processing elements configured to execute a spanning tree protocol engine, the spanning tree protocol engine to implement a Rapid Spanning Tree Protocol (RSTP) to transition at least some of the intermediate network device’s ports among a plurality of port states, including a discarding port state, a listening port state, and a forwarding port state” 156
 - iii. “the one or more processing elements further configured to execute a loop guard engine, the loop guard engine to cooperate with the spanning tree protocol engine, the loop guard engine configured to, in response to a stoppage of a periodic receipt of bridge protocol data units (BPDUs) on a given port, prevent the given port from transitioning to the

Public Version

	forwarding port state, if the given port is in a port state other than the forwarding port state”	157
	iv. Conclusion	158
b)	Claims 3 and 4.	158
3.	No Direct Infringement of the ’875 and ’492 Patents in the United States	159
4.	No Indirect Infringement	159
E.	Technical Prong	161
1.	Cisco’s DI Products	161
2.	’875 Patent	161
a)	Claim 1.....	161
i.	“In an intermediate network device having a plurality of ports for forwarding network messages within a bridged network, a method for preventing the formation of loops within the bridged network, the method comprising the steps of”.....	161
ii.	“executing a spanning tree protocol (STP) at the intermediate network device so as to elect a root of the bridged network and to transition at least one of the device’s ports among a plurality of spanning tree port states, including a discarding state, a listening state and a forwarding state”.....	162
iii.	“periodically receiving configuration bridge protocol data unit (BPDU) messages at one or more of the device’s ports”	163
iv.	“in response to the periodic receipt of BPDU messages being stopped on a given port, (1) preventing the given port from transitioning to the forwarding spanning tree port state, if the given port is in a spanning tree port state other than the forwarding spanning tree port state, or (2) precluding the given port from forwarding or receiving network messages, if the given port is in the forwarding spanning tree port state”.....	163
v.	Conclusion	164
b)	Claims 2, 3, and 4.	164
c)	Claim 10.....	165

Public Version

- i. “An intermediate network device configured to receive and forward network messages within a bridged network, the device having a plurality of ports for connecting the device to one or more network entities or other devices, the intermediate network device comprising” 165
- ii. “a spanning tree protocol (STP) engine configured and arranged to elect a root of the bridged network and to transition at least some of the device’s ports among a plurality of spanning tree port states, including a discarding or blocking state, a listening state and a forwarding state” 165
- iii. “a loop guard engine cooperating with the STP engine, wherein configuration bridge protocol data unit (BPDU) messages are periodically received at one or more of the device’s ports” 166
- iv. “in response to the periodic receipt of BPDU messages being stopped on a given port, the loop guard engine (1) prevents the given port from transitioning to the forwarding spanning tree port state, if the given port is in a spanning tree port state other than the forwarding spanning tree port state, or (2) precludes the given port from forwarding or receiving network messages” 167
- v. Conclusion 167
- d) Conclusion 168
- 3. ’492 Patent 168
 - a) Claim 1 168
 - i. “An intermediate network device configured to receive and forward network messages, the intermediate network device having a plurality of ports to connect the intermediate network device to one or more other devices, the intermediate network device comprising” 168
 - ii. “one or more processing elements configured to execute a spanning tree protocol engine, the spanning tree protocol engine to implement a Rapid Spanning Tree Protocol (RSTP) to transition at least some of the intermediate network device’s ports among a plurality of port states, including a discarding port

	state, a listening port state, and a forwarding port state”	169
	iii. “the one or more processing elements further configured to execute a loop guard engine, the loop guard engine to cooperate with the spanning tree protocol engine, the loop guard engine configured to, in response to a stoppage of a periodic receipt of bridge protocol data units (BPDUs) on a given port, prevent the given port from transitioning to the forwarding port state, if the given port is in a port state other than the forwarding port state”	170
	iv. Conclusion	170
	b) Claims 3 and 4.	171
F.	Validity	171
	1. Anticipation by Di Benedetto	171
	i. Claims 1 and 10 of ’875 Patent; Claim 1 of ’492 Patent.....	173
	ii. Claims 2-4 of ’875 Patent; Claims 3 and 4 of ’492 Patent.....	175
	2. Patent Eligibility	177
VII.	THE ’668 PATENT.....	180
A.	Person of Ordinary Skill in the Art.....	180
B.	Disputed Terms.....	180
	1. Claims 1, 55—“ <i>port services</i> ”	180
	2. Claims 1-2, 5, 13, 56—“ <i>control plane port entity</i> ”/“ <i>control plane port</i> ”	182
	3. Claim 7—“ <i>multiple processors</i> ”	184
	4. Claim 8—“ <i>aggregate control plane function</i> ”	186
	5. Claims 10, 64—“ <i>distributed control plane port services</i> ”	188
	6. Preamble of Claim 55	190
C.	Infringement.....	190
	1. Accused ’668 Products	190
	2. Direct Infringement.....	192
	a) Claims 1 and 55.	193
	i. “[A computer readable storage medium containing instructions readable by a computer to configure the	

Public Version

	computer to perform a method for processing packets in] An internetworking device comprising”	193
ii.	“[configuring] a plurality of physical network interface ports, each for providing a physical connection point to a network for the internetworking device, the ports being configurable by control plane processes”	193
iii.	“[executing] port services, for operating on packets entering and exiting the physical network interface ports, the port services providing an ability to control and monitor packet flows, as defined by control plane configurations”	194
iv.	“[executing] a control plane, comprising a plurality of internetworking control plane processes, the control plane processes for providing high-level control and configuration of the ports and the port services”	195
v.	“[accessing the collection of control plane processes as] a control plane port entity provides access to the collection of control plane processes, so that a set of control plane port services can be applied thereto”	195
vi.	“[operating] the control plane port services operate on packets received from specific, predetermined physical ports and destined to the collection of control plane processes in a way that is independent of the [individual] physical port interfaces [physical port interface configuration] and [port] services applied thereto”	197
b)	Claim 2.....	204
i.	A device as in claim 1 wherein the control plane processes are accessible through a control plane port on the internetworking device, such that control plane packets originating at a plurality of physical ports and destined to one of a plurality of control plane processes are first processed through the control plane port, rather than to individual control plane processes.	204
c)	Claim 4.....	205
i.	A device as in claim 3 wherein the control plane port services are applied after a transit packet forwarding decision is made.	205

Public Version

d)	Claim 5.....	207
	i. A device as in claim 3 wherein Layer 2 control packets are identified and forwarded to the control plane port.	207
e)	Claim 7.....	207
	i. A device as in claim 1 wherein the control plane processes are distributed across multiple processors.	207
f)	Claim 8.....	208
	i. A device as in claim 1 wherein the control plane port services are implemented as an aggregate control plane function applied to packets received from multiple physical ports on the internetworking device.	208
g)	Claim 10.....	209
	i. A device as in claim 1 wherein the control plane port services are implemented as distributed control plane port services, and wherein the distributed control plane port services are applied only to the packets received from the specific, pre-determined physical ports.....	209
h)	Claim 13.....	210
	i. A device as in claim 10 wherein one or more distributed switch engines deliver packets to the control plane port.	210
i)	Claim 18.....	211
	i. A device as in claim 1 where in control plane port services are controlled and configured as unique entity, separate from physical port services.	211
j)	Claim 56.....	212
	i. A medium as in claim 55 wherein the control plane port processes packets originating at a plurality of physical ports, the method additionally comprising: passing packets through the control plane port, rather than directly from the physical ports to individual control plane processes.	212
k)	Claim 64.....	213
	i. A medium as in claim 55 additionally comprising: applying distributed control plane port services only	

Public Version

	to the packets received from the specific, pre-determined physical ports	213
l)	Direct Infringement of the '668 Patent in the United States.....	213
3.	Indirect Infringement	214
a)	Induced Infringement.....	215
i.	Direct Infringement.....	215
ii.	Specific Intent to Cause Infringement	215
iii.	Active Inducement to Infringe the '668 Patent.....	219
b)	Contributory Infringement.....	220
c)	Conclusion	223
D.	Technical Prong	224
E.	Validity	227
1.	Anticipation.....	228
a)	JUNOS Guide	228
i.	Prior Art Status	228
ii.	Claim 1, 2, 4, 5, 8, 18, and 56	230
b)	Amara.....	230
i.	Claims 1 and 55	230
ii.	Claims 2, 4, 5, 8, 18, and 56	233
2.	Obviousness	233
a)	Claim 7 in view of JUNOS and Moberg.....	233
b)	Claim 7 in view of Amara and Moberg	234
c)	Claims 10, 13, and 64 in view of JUNOS and Subramanian.....	235
d)	Claims 10, 13, and 64 in view of Amara and Subramanian	235
e)	Secondary Considerations.....	237
f)	Conclusion	237
VIII.	THE '211 PATENT.....	238
A.	Person of Ordinary Skill in the Art.....	238
B.	Infringement.....	238
1.	'211 Accused Switches	238
2.	Direct Infringement.....	239
a)	Claims 1 and 12.	239

Public Version

i.	“aggregating [configured to aggregate] a plurality of LANs, wherein said aggregating comprises aggregating [configured to aggregate] a first LAN and a second LAN”	240
ii.	“said first LAN couples a host to a first intermediate device and said second LAN couples said host to a second intermediate network device, said plurality of LANs comprising said first LAN and said second LAN”	241
iii.	“subsequent to said aggregating, said first LAN and said second LAN are both usable to simultaneously transmit information from said host to said second intermediate network device”	243
iv.	Conclusion	244
b)	Claims 2 and 13.	244
i.	“The method of claim 1 [The computer program of claim 12], further comprising: tunneling [configured to tunnel] said first LAN with a third LAN through said first intermediate network device, said plurality of LANs comprising said third LAN.”	244
c)	Claims 6 and 17.	250
d)	Conclusion	250
3.	No Direct Infringement of the ’211 Patent in the United States.....	250
4.	No Indirect Infringement	251
C.	Technical Prong	252
1.	Cisco’s DI Products.	252
2.	Claims 1 and 12.	252
a)	“aggregating [configured to aggregate] a plurality of LANs, wherein said aggregating comprises aggregating [configured to aggregate] a first LAN and a second LAN”	252
b)	“said first LAN couples a host to a first intermediate device and said second LAN couples said host to a second intermediate network device, said plurality of LANs comprising said first LAN and said second LAN”	253
c)	“subsequent to said aggregating, said first LAN and said second LAN are both usable to simultaneously transmit information from said host to said second intermediate network device”	254

Public Version

d)	Conclusion	254
3.	Claims 2 and 13.	255
a)	“The method of claim 1 [The computer program of claim 12], further comprising: tunneling [configured to tunnel] said first LAN with a third LAN through said first intermediate network device, said plurality of LANs comprising said third LAN.”.....	255
4.	Claims 6 and 17.	256
a)	“The method of claim 2 [The computer program product of claim 13] wherein said aggregating comprises: aggregating [configured to aggregate] a first and a second port of said second intermediate network device, wherein said first port is coupled to said first intermediate network device over said third LAN, and said second port is coupled to said host over said second LAN.”	256
5.	Conclusion	257
D.	Validity	258
1.	Perloff	258
2.	Anticipation.....	258
3.	Obviousness	259
a)	Perloff	259
i.	Claims 2 and 13	260
(a)	“The method of claim 1 [The computer program of claim 12], further comprising: tunneling [configured to tunnel] said first LAN with a third LAN through said first intermediate network device, said plurality of LANs comprising said third LAN.”.....	260
ii.	Claims 6 and 17	262
(a)	“The method of claim 2 [The computer program product of claim 13] wherein said aggregating comprises: aggregating [configured to aggregate] a first and a second port of said second intermediate network device, wherein said first port is coupled to said first intermediate network device over said third LAN, and said second port is coupled to said host over said second LAN.”.....	262
b)	Secondary Considerations.....	263

c)	Conclusion	263
IX.	DEFENSES.....	263
A.	Equitable Estoppel	263
1.	There Was No Misleading Conduct by Cisco.....	264
2.	There Was No Reliance by Arista	267
3.	There Was No Prejudice to Arista	269
B.	Implied License and Waiver	270
1.	There Was No Implied License	271
2.	There Was No Waiver	271
C.	Laches	273
D.	Unclean Hands	275
E.	Patent Misuse.....	277
X.	ECONOMIC PRONG OF THE DOMESTIC INDUSTRY.....	278
A.	Legal Framework of the Economic Prong	278
B.	Sections A, B, and C of Subsection 337(a)(3).....	279
C.	Cisco Has Met Its Burden with Regard to the Economic Prong.....	280
D.	Complainant Has Established a Domestic Industry with Respect to the Asserted Patents and Products Relating to Patents Under 19 U.S.C. § 1337(a)(3)(A), (B) and (C) 282	
1.	Cisco’s Investments Under 19 U.S.C. § 1337(a)(3)(C).....	282
2.	Cisco’s Investments Under Cisco’s Investments Under 19 U.S.C. § 1337(a)(3)(A).....	288
3.	Cisco’s Investments Under 19 U.S.C. § 1337(a)(3)(B).....	290
XI.	WAIVER OR WITHDRAWAL OF ARISTA’S OTHER DEFENSES.....	291
XII.	CONCLUSIONS OF LAW	292
	RECOMMENDED DETERMINATION ON REMEDY AND BOND	294
XIV.	REMEDY AND BONDING.....	294
A.	Limited Exclusion Order.....	294
B.	Cease and Desist Order	298
C.	Bond During the Presidential Review Period	299
XV.	CONCLUSION	302

APPENDICES

Appendix A: Agreed Upon and Construed Claim Constructions

Appendix B: Chart Listing Arista's Products Subject to the Limited Exclusion Order

Public Version

ABBREVIATIONS

The following abbreviations for pleadings, exhibits, briefs, and Orders are used in this Initial Determination:

Compl.	Complaint
Resp.	Response of Arista Networks Inc. to the Notice of Investigation and Complaint of Cisco Systems, Inc. Under Section 337 of the Tariff Act of 1930, as Amended
CX	Complainant's exhibit
CDX	Complainant's demonstrative exhibit
CPX	Complainant's physical exhibit
CPBr.	Complainant Cisco Systems, Inc.'s Pre-Hearing Brief
CBr.	Complainant Cisco Systems, Inc.'s Corrected Initial Post-Hearing Brief (on all issues other than the '577 and '853 patents)
CBr.II	Complainant Cisco Systems, Inc.'s Initial Post-Hearing Brief Concerning the '577 and '853 Patents
CRBr.	Complainant Cisco Systems, Inc.'s Post-Hearing Reply Brief (on all issues other than the '577 and '853 patents)
CRBr.II	Complainant Cisco Systems, Inc.'s Reply Post-Hearing Brief Concerning the '577 and '853 Patents
CPSt.	Complainant Cisco Systems, Inc.'s Pre-Hearing Statement
JX	Joint exhibit
RX	Respondent's exhibit
RDX	Respondent's demonstrative exhibit
RPX	Respondent's physical exhibit

Public Version

RPBr.	Respondent Arista Networks, Inc.'s Corrected Prehearing Brief ¹
RBr.	Respondent Arista Networks, Inc.'s Corrected Posthearing Brief Concerning the '668, '875, '492, and '211 Patents
RBr.II	Respondent Arista Networks, Inc.'s Post-Hearing Brief Concerning the '577 and '853 Patents
RRBr.	Respondent Arista Networks, Inc.'s Reply Post-Hearing Brief Concerning the '668, '875, '492, and '211 Patents
RRBr.II	Respondent Arista Networks, Inc.'s Reply Post-Hearing Brief Concerning the '577 and '853 Patents
RPSSt.	Respondent Arista Networks, Inc.'s Pre-Hearing Statement
SPBr.	Commission Investigative Staff's Pre-Hearing Brief
SBr.	Commission Investigative Staff's Initial Post-Hearing Brief on All Issues Other Than the '577 and '853 Patents
SBr.II	Commission Investigative Staff's Initial Post-Hearing Brief on the '577 and '853 Patents
SRBr.	Commission Investigative Staff's Reply Post-Hearing Brief on All Issues Other Than the '577 and '853 Patents
SRBr.II	Commission Investigative Staff's Reply Post-Hearing Brief on the '577 and '853 Patents
SX	Staff's exhibit
Tr.	Hearing transcript
Markman Order	Order No. 45, Construing the Terms of the Asserted Claims of the Patents at Issue

The following abbreviations for technical and business-related terms are used in this Initial Determination:

¹ Arista filed a corrected Pre-Hearing Brief on October 16, 2015. (Doc. ID No. 567368.). On November 16, 2015, Arista filed a second corrected Pre-Hearing Brief that had issues that were rendered moot by the *Markman* Order and redacted. (Doc. ID No. 569155.). All citations to Arista's Pre-Hearing Brief refer to the first corrected, non-redacted Pre-Hearing Brief filed on October 16, 2015. (Doc. ID No. 567368.).

ACL	Access Control List
API	Application Program Interface
ARP	Address Resolution Protocol
ASIC	Application-Specific Integrated Circuit
BGP	Border Gateway Protocol
BPDU	Bridge Protocol Data Unit
BPF	Berkeley Packet Filter
BU	Business Unit
CAM	Content Addressable Memory
CFS	Cisco Fabric Services
CLI	Command Line Interface
CoPP	Control Plane Policing/Control Plane Protection
CP-ACL	Control Plane Access Control List
CPDM	Cisco Product Design Methodology
CPU	Central Processing Unit
CRAP	Cisco Receive Adjacency Protection
DoS	Denial of Service
EBBU	Enterprise Backbone Business Unit
ECBU	Enterprise Core Business Unit
EOS	“Extensible Operating System”
ERBU	Edge Routing Business Unit

FDDI	Fiber Distributed Data Interface
FFU	Filtering and Forwarding Unit
IBM	International Business Machines
IEEE	Institute of Electrical and Electronics Engineers
IETF	Internet Engineering Task Force
IGMP	Internet Group Management Protocol
INSBU	Insieme Business Unit
IOS XR	Internetworking Operating System XR
IPSEC	Internet Protocol Security
IST	Inter-Switch Trunk
L2	Layer 2
L3	Layer 3
LACP	Link Aggregation Control Protocol
LACPDU	Link Aggregation Control Protocol Data Unit
LAG	Link Aggregation Group
LLDP	Link Layer Discovery Protocol
LSS	Logical Switch Set
LSSS	Load Sharing Switch Set
MAC	Media Access Control
MDLA	Multi-Device Link Aggregation
MEC	Multichassis EtherChannel
MLAG	Multichassis Link Aggregation

Public Version

MPLS	Multiprotocol Label Switching
MST	Multiple Spanning Tree Protocol
OSPF	Open Shortest Path First
PAGP	Port-Aggregation Protocol
PC	Personal Computer
PIM	Protocol Independent Multicast
PiP CoPP	Per-Input Port Control Plane Policing
PMF	Programmable Mapping and Filtering
PVST	Per VLAN Spanning Tree Protocol
QoS	Quality of Service
rACL	Receive Access Control List
RAM	Random Access Memory
RSTP	Rapid Spanning Tree Protocol
SAVBU	Server Access and Virtualization Business Unit
SIGCOMM	The Association for Computing Machinery's Special Interest Group on Data Communications
SMLT	Split Multi-Link Trunk
STP	Spanning Tree Protocol
STP BPDU	Spanning Tree Protocol Bridge Protocol Data Unit
TCAM	Ternary Content Addressable Memory
TCP SYN	Transmission Control Protocol Synchronize
TCP/IP	Transmission Control Protocol/Internet Protocol
UABU	Unified Access Business Unit

vPC Virtual Port-Channel

I. BACKGROUND

A. Institution.

By publication of a Notice of Investigation (“NOI”) in the Federal Register on January 27, 2015, pursuant to subsection (b) of Section 337 of the Tariff Act of 1930, as amended, the Commission instituted Investigation No. 337-TA-945 with respect to U.S. Patent No. 7,023,853 (“the ’853 patent”), U.S. Patent No. 6,377,577 (“the ’577 patent”), U.S. Patent No. 7,460,492 (“the ’492 patent”), U.S. Patent No. 7,061,875 (“the ’875 patent”), U.S. Patent No. 7,224,668 (“the ’668 patent”), and U.S. Patent No. 8,051,211 (“the ’211 patent”) (collectively, the “Asserted Patents”) to determine:

whether there is a violation of subsection (a)(1)(B) of section 337 in the importation into the United States, the sale for importation, or the sale within the United States after importation of certain network devices, related software and components thereof by reasons of infringement of one or more of the claims 46-52, 54, 56, and 59-63 of the ’853 patent; claims 1, 2, 5, 7-10, 12-16, 18-22, 25, and 28-31 of the ’577 patent; claims 1-4, 9-14, 17, and 18 of the ’492 patent; claims 1-4, 10-13, and 15 of the ’875 patent; claims 1-10, 12, 13, 15-28, 30, 31, 33-43, 45-49, 51-64, 66, 67, and 69-72 of the ’668 patent; and claims 1, 2, 6-9, 12, 13, and 17-20 of the ’211 patent, and whether an industry in the United States exists as required by subsection (a)(2) of section 337[.]

80 Fed. Reg. 4313 (Jan. 27, 2015). The NOI names Cisco Systems, Inc. as complainant and Arista Networks, Inc. as respondent. *Id.* The Commission Investigative Staff of the Office of Unfair Import Investigations (“Staff”) is also a party in this Investigation. Administrative Law Judge Pender was initially the presiding administrative law judge for this Investigation. On August 10, 2015, Chief Administrative Law Judge Bullock assigned this Investigation to Administrative Law Judge McNamara.

B. The Parties.

1. Complainant Cisco Systems, Inc.

Cisco Systems, Inc. (“Cisco” or “Complainant”) is a corporation organized under the laws of California, with its principal place of business in San Jose, California. (Compl. at ¶ 7.). Cisco is an IT company in the business of supplying networking products, among other things. (*Id.* at ¶ 8.).

According to Cisco, it is “the worldwide leading supplier of networking products,” with research, development, testing, engineering, manufacturing, assembly, packaging, installation, customer service, repair, product support, marketing, and business offices in more than 100 U.S. locations. (CPBr. at 2.). Cisco employs about half of its more than 70,000 employees in the U.S. (*Id.*). A significant part of Cisco’s U.S. operations relate to products that practice Cisco’s asserted patents. (*Id.*). The technologies covered by Cisco’s asserted patents arose from Cisco’s research and development (“R&D”) and the inventive contributions of Cisco’s engineers and scientists. (*Id.*). Cisco has made and continues to make significant U.S. based investments in the design and development of products protected by Cisco’s asserted patents. (*Id.*). Cisco exploits these patented technologies in the U.S. through various activities, including substantial research and development, engineering, manufacturing, installation, and product and warranty support among others. (*Id.*).

2. Respondent Arista Networks, Inc.

Arista Networks, Inc. (“Arista” or “Respondent”) is a corporation organized under the laws of Delaware, with its principal place of business in Santa Clara, California. (*Id.* at ¶ 12.).

According to Arista, it started from a clean sheet of paper and invested more than 1,000 person-years building a new, open software architecture that offered customers an alternative to

Cisco's traditional closed, enterprise system. (RPBr. at 1.). This was Arista's award-winning Extensible Operating System ("EOS"),² the most programmable and resilient network operating system in the industry. (*Id.*). In 2008, Arista shipped its first EOS-based switch product,³ and today EOS powers every Arista switch. (*Id.*). Headquartered in Santa Clara, California, Arista employs more 750 people in the United States and now provides its solutions to more than 3,000 customers including such famed companies like Microsoft, eBay, Facebook, and many others that operate networks in the cloud. (*Id.*). Arista's EOS-based switch products were a truly disruptive technical leap in the market place. (*Id.*). According to Arista's description of its market force, Arista has made a mark and has become a leader in the datacenter and cloud switching market. (*Id.*).

C. Procedural History.

1. Generally

On June 15-16, 2015, Administrative Law Judge Pender held a *Markman* hearing in order to permit the parties to present their positions with respect to the interpretation of certain disputed claim language in the asserted patents. Counsel for Cisco and Arista, as well as Staff, attended the *Markman* hearing.

On August 10, 2015, Chief Administrative Law Judge Bullock assigned this Investigation to me.

On July 7, 2015, Administrative Law Judge Pender issued an Initial Determination

² "EOS" is an acronym for "Extensible Operating System." (*See, e.g.,* CX-0221 at CSI-ANI-00128383.000044.). EOS is the interface between the switch and the software that controls the switch and manages the network. (*Id.*).

³ A "switch" is "an intermediate network device that combines some or all of the functions of both a router and a bridge." (JX-0001 at 1:62-64.).

Public Version

terminating certain asserted patent claims from the Investigation. (Order No. 20.). Claims 61 and 62 of the '853 patent; claim 31 of the '577 patent; claim 12 of the '875 patent; claims 9, 12, 25, 30, 34, 36, 61, and 66 of the '668 patent; and claims 8 and 19 of the '211 patent were terminated from the Investigation. (*Id.*) The Commission determined not to review this Initial Determination. (*See* Notice of Commission Determination Not to Review an Initial Determination Granting a Motion for Partial Termination of Certain Asserted Patent Claims, dated July 29, 2015.).

On October 27, 2015, I issued a second Initial Determination terminating certain asserted patent claims from the Investigation. (Order No. 38.).⁴ Claims 48, 49, 51, 52, 56, 59, and 60 of the '853 patent; claims 5, 8, 12-14, 16, 18-21, and 25 of the '577 patent; claims 11, 13, and 15 of the '875 patent; claims 3, 6, 15-17, 19-24, 26-28, 31, 33, 35, 38-42, 48, 49, 51-55, 57-60, 62, 63, 67, and 69-72 of the '668 patent; claims 2, 9-14, 17, and 18 of the '492 patent; and claims 7, 9, 18, and 20 of the '211 patent were terminated from the Investigation. (*Id.*) The Commission determined not to review the October 27, 2015 Initial Determination. (*See* Notice of Commission Determination Not to Review an Initial Determination Terminating the Investigation as to Certain Patent Claims, dated November 18, 2015.).

On November 5, 2015, I issued Order No. 45 (the "*Markman* Order") construing certain claim terms of the asserted patents in this Investigation.

On November 9, 2015, I issued a third Initial Determination terminating certain asserted patent claims from the Investigation. (Order No. 47.). Claims 22, 28, 29, and 30 of the '577 patent; claims 47, 50, and 54 of the '853 patent; claims 37, 43, 45, 46, and 47 of the '668 patent;

⁴ On October 29, 2015 and November 10, 2015, a corrected second initial determination and a second corrected second initial determination issued, respectively. (*See* Doc. ID Nos. 560875, 568728.).

and claims 1 and 12 of the '211 patent were terminated from the Investigation. (*Id.*). The Commission determined not to review the November 9, 2015 Initial Determination. (*See* Notice of Commission Determination Not to Review an Initial Determination Terminating the Investigation as to Certain Patent Claims, dated December 1, 2015.).

The evidentiary hearing on the question of violation of Section 337 was held on November 9-20, 2015 and December 9, 2015. Cisco, Arista, and Staff were represented by counsel at the hearing. (Tr. at 2:1–6:12.).

2. Motions to Strike

a) Cisco's Motions to Strike

i. Cisco's Motion to Strike 1

Cisco moved to strike any evidence and testimony or argument pertaining to an argument that the claimed “control plane port services” must be “configurable”: Tr. (Mir) at 1608:12–1609:7, 1617:3-10, 1650:13-21, 1651:12-17, 1651:19–1652:4, 1652:9-15; RDX-1015, 1017, 1024, 1033, 1038C, 1045, 1046C, 1047C, 1048; RDX-0550C; JX-0032C 372:14-23. Cisco claimed that Dr. Nader Mir's⁵ testimony and Arista's arguments regarding the construction of this term were untimely and in contravention of Order No. 43. (*Id.* at 61; Doc ID. No. 568754 (Joint Report Regarding Parties' Efforts to Further Reduce Disputed Terms) at 10.).

Order No. 43 explicitly states that “[n]o new claim construction” would be permitted “of

⁵ At the time of his testimony, Dr. Nader Mir (“Dr. Mir”) was a Professor at San Jose State University, Department of Electrical Engineering. (RPSt. at Ex. B.). Dr. Mir was also a Director of the Lockheed Martin Space Company MSE Optoelectronic Sensor Networks Program at San Jose State University. (*Id.*). Arista retained Dr. Mir as an expert to provide testimony regarding: (1) the scope and content of the '668, '875, and '492 patents; (2) the interpretation of certain terms of the asserted claims of the '668, '875, and '492 patents, the invalidity of the '668, '875, and '492 patents; (3) the prior art and background of the relevant technology with respect to these patents; (4) the appropriate level of ordinary skill in the art with respect to these patents; (5) the accused products with respect to these patents; (6) Cisco's infringement allegations with respect to these patents; (7) the alleged domestic industry products with respect to these patents; and (8) opinions offered by Cisco's expert witnesses with respect to these patents. (*Id.* at 3.).

Public Version

any of the other terms not otherwise included in the claim construction charts” and that “no testimony with regard to any affirmative, new constructions will be permitted by either party.” (Order No. 43 at 11.). Since Arista did not raise the term “control plane port service” for construction and did not propose a construction for the term “port services” that required configurability, under Order No. 43, a new claim construction either before the hearing or during the hearing was too late. (*See* Doc ID. No. 568754 (Joint Report Regarding Parties’ Efforts to Further Reduce Disputed Terms) at 10.). Arista’s argument at the evidentiary hearing, that it was not presenting a claim construction argument on port services but simply “applying claim 1,” is unpersuasive and without merit. (Tr. at 1612:22-24.). Arista’s attempted new claim construction is unsupported, and untimely. Accordingly, Cisco’s motion to strike the following testimony and evidence: Tr. (Mir) at 1608:12–1609:7, 1617:3-10, 1650:13-21, 1651:12-17, 1651:19–1652:4, 1652:9-15; RDX-1015, 1017, 1024, 1033, 1038C, 1045, 1046C, 1047C, 1048; RDX-0550C; JX-0032C 372:14-23, is granted, and the forgoing references have been stricken.

ii. Cisco’s Motion to Strike 2

Cisco moved to strike Dr. Mir’s testimony with regard to whether and when “Junos Internet Software configuration Guide, Interfaces, Class of Service, and Firewalls, Release 5.0” (“JUNOS Guide”) became publicly available. (CBr. at 61.). Cisco argued that Dr. Mir’s testimony exceeded the scope of his expert report and that he provided testimony without any proper foundation or basis. (*Id.* (citing Tr. (Mir) at 1669:6–1670:19; RRB., App. B (Mir Expert Report) at ¶ 337).). Cisco argued that Dr. Mir’s testimony at the hearing was beyond the scope of his expert report. (*See* Tr. (Mir) at 1669:6–1670:19; RRB., App. B (Mir Expert Report) at

Public Version

¶ 337.). As Cisco argued rightly, the Declaration of [] upon which Arista relied does not certify unequivocally that *this* particular document, that is, the JUNOS Guide, was actively made available to the public before December 2002.⁷ With regard to the JUNOS Guide, [

There is no mention of whether the JUNOS Guide was made publicly available on or around that date. Additionally, it is not clear, and was not established, how Dr. Mir knew about Juniper Networks, Inc.'s business practices in 2002. Therefore, Dr. Mir was not able to authenticate the JUNOS Guide and was not a knowledgeable witness. Some type of corroborating evidence is needed to establish public availability of prior art. *See, e.g., In re Enhanced Sec. Research, LLC*, 739 F.3d 1347, 1354-55 (Fed. Cir. 2014) (concluding that software manual was prior art based on manual's inscription date combined with a declaration from the CEO of the software company); *Certain Semiconductor Chips and Prods. Containing Same*, Inv. No. 377-TA-753, Initial Determination at 105 (Mar. 2, 2012) (finding public availability where specification with 1990 copyright date was incorporated by reference into other, publicly available documents); *Certain Silicon Microphone Packages and Prods. Containing the Same*, Inv. No. 337-TA-695, Initial Determination, 2010 WL 5199618, at

⁶ [

]

⁷ U.S. Application No. 10/307,154, from which the '668 patent issued, was filed on November 27, 2002. (*See* JX-0002.).

Public Version

*66 (U.S.I.T.C. Nov. 22, 2010) (concluding that copyright date corroborated by catalog listing from the U.S. Copyright Office was sufficient to show public availability).

Accordingly, Cisco's motion to strike Dr. Mir's testimony with regard to the public availability of the JUNOS Guide is granted, and all references thereto have been stricken.

iii. Cisco's Motion to Strike 3

Cisco moved to strike certain testimony by Dr. Roch Guerin⁸ (Tr. (Guerin) 1472:4–1476:15) and to preclude Arista from belatedly presenting invalidity theories based on Dr. Guerin's testimony that the asserted claims of the '211 patent are rendered obvious by a combination of Perloff with alleged "known techniques" that were not previously alleged in any invalidity theory and was improperly raised for the first time in its initial Post-Hearing Brief. (CBr. at 86 (citing RPSt., Ex. F-3 at 1-3; CX-2551C⁹); CRBr. at 61.).

Because Arista failed to raise in its Pre-Hearing Brief an invalidity contention that the '211 patent was obvious based on the combination of Perloff with the "known techniques" of the "encapsulation" technique allegedly found in a textbook by Kurose and Ross (RPBr. at 187-89), and the "physical tunnel" technique allegedly found in an embodiment of the '211 patent (*id.*), under Ground Rule 11.2, Arista is deemed to have abandoned or withdrawn this contention. (*See* G.R. 11.2 ("Any contentions not set forth with the level of particularity required herein shall be

⁸ At the time he testified, Dr. Roch Guerin ("Dr. Guerin") was currently a Professor at Washington University, Saint Louis, Department of Computer Science and Engineering. (RPSt. at Ex. A.). Dr. Guerin is also Department Chair of the Department of Computer Science and Engineering at Washington University, Saint Louis. (*Id.*). Arista retained Dr. Guerin as an expert to provide testimony regarding: (1) the scope and content of the '211 patent; (2) interpretation of certain claim terms of the '211 patent; (3) invalidity of the '211 patent; (4) prior art and relevant background with respect to the '211 patent; (5) the '211 accused products; (6) Cisco's infringement allegations with respect to the '211 patent; and (7) Cisco's DI allegations with respect to the '211 patent; and (8) opinions offered by Cisco's expert witnesses with respect to the '211 patent. (*Id.* at 3.).

⁹ This exhibit has been withdrawn and is not part of the record evidence in this Investigation.

Public Version

deemed abandoned or withdrawn.”). Essentially, this aspect of Cisco’s motion to strike is moot since Arista is deemed to have abandoned or withdrawn any such contention.

Cisco also moved to strike certain hearing testimony Dr. Guerin provided with regard to the issue of “tunneling.” (CBr. at 86.). As Dr. Guerin testified and Cisco pointed out, Dr. Guerin analyzed validity for the claim 2, which recites the “tunneling” limitation, using Cisco’s proposed construction. (Tr. (Guerin) at 1490:1-5.). Since that proposed construction was not adopted, Dr. Guerin should have provided a supplemental report laying out his invalidity opinion based on the adopted construction, which he failed to do. (*Markman* Order at 76; Tr. (Guerin) at 1492:10-12.). Accordingly, Cisco’s motion to strike Dr. Guerin’s testimony at 1472:4–1476:15 is granted, and all referenced testimony by Dr. Guerin is stricken.

iv. Cisco’s Motion to Strike 4

Cisco moved to strike Arista’s expert Dr. James Olivier’s¹⁰ opinion that the term “said set” in claim 1 of the ’577 patent and claim 46 of the ’853 patent should be construed in light of the “generating” step. (CBr.II at 50.). Cisco also moved to strike Arista’s assertion based on Dr. Olivier’s opinion that the claimed step of “matching . . . with said set of access control patterns in parallel” should be construed to require matching *all* access control patterns in parallel. (*Id.*). Cisco argued that Dr. Olivier’s opinion was untimely because it was presented for the first time during the hearing and was not previously disclosed in Dr. Olivier’s expert report. (*Id.*).

¹⁰ At the time of his testimony, Dr. James Olivier (“Dr. Olivier”) was an Intellectual Property Consultant for Olivier Consulting Inc. and McAlexander Sound, Inc. (RPSt. at Ex. C.). Arista retained Dr. Olivier as an expert to provide testimony with regard to: (1) the scope and content of the ’577 and ’853 patents; (2) interpretation of certain terms of the asserted claims of the ’577 and ’853 patents; (3) invalidity of the ’577 and ’853 patents (4) prior art and background of the relevant technology with respect to these patents; (5) the appropriate level of ordinary skill in the art with respect to these patents; (6) the accused products with respect to these patents; (7) Cisco’s infringement allegations with respect to these patents; (8) the alleged DI products with respect to these patents; and (8) opinions offered by Cisco’s expert witnesses with respect to these patents. (*Id.* at 4.).

Public Version

Arista opposed Cisco's motion. Arista argued that Cisco's expert Dr. Kevin Almeroth¹¹ testified for the first time during the hearing about the relationship between the "set of access control specifiers" and the "generating" step, and that Dr. Olivier's allegedly untimely opinion is a necessary rebuttal to Dr. Almeroth's new opinion. (RRBr.II at 36-37.). Arista also noted that Order No. 43 permits the parties to rebut each other's interpretation of the plain and ordinary meaning of claim terms and that Cisco's objection at the hearing was overruled. (*Id.* (citing Order No. 43 at 11; Tr. at 2749:6-21)).

Staff opposed Cisco's motion, arguing that Dr. Olivier's testimony constituted an explication of the plain and ordinary meaning, permitted by Order No. 43. (SRBr.II at 38.).

During the hearing, in response to an objection by Cisco's counsel, a ruling was made that Dr. Olivier's rebuttal testimony would be allowed. (Tr. (McNamara) at 2749:10-11 ("[W]ith regard to this rebuttal testimony, I'm going to allow it."). Moreover, the transcript reflects that a ruling was made that Dr. Olivier "certainly, as an expert, can talk about a person of ordinary skill's understanding of certain of the claims." (*Id.* at 2749:18-20.). This statement is consistent with Order No. 43, which permits each party to rebut each other's interpretations of the plain and ordinary meaning of claim constructions. (*See* Order No. 43 at 11.). Moreover, Arista and Staff's argument that Dr. Olivier's opinion with regard to claim construction is a fair rebuttal of Dr. Almeroth's claim construction opinions is persuasive. (*See* Tr. (McNamara) at 2749:16 ("I think this is rebuttal.")). Accordingly, Cisco's motion to strike is denied.

¹¹. At the time of his testimony, Dr. Kevin Almeroth ("Dr. Almeroth") was a Professor in the Department of Computer Science at the University of California, Santa Barbara. (CPSt. at Ex. B.). Cisco retained Dr. Almeroth as an expert to provide testimony with regard to the claim construction, technical background, infringement, and validity of the '853, '577, and '668 patents. (*Id.* at 1-2.).

Public Version

v. Cisco's Motion to Strike 5

Cisco moved to strike Arista's expert Dr. Olivier's testimony regarding testing of the accused Alta products. (CBr.II at 51.). Cisco argued that Dr. Olivier performed certain testing on the accused Alta products after the hearing began, and then submitted a belated second supplemental report with new opinions regarding his testimony. (*Id.*).

Arista opposed Cisco's motion, arguing that Dr. Olivier's testimony was a permissible rebuttal to a new opinion from Cisco's expert, Dr. Almeroth. (RRBr.II at 39.). Specifically, Arista noted that Dr. Almeroth's testimony during the hearing about whether an ACL was stored in a single CAM went beyond his expert report's discussions about his testing of the CAM. (*Id.*).

Staff noted that Cisco's motion "presents a close question" but ultimately opposed the motion. (SRBr.II at 39.). Staff agreed with Arista that Dr. Almeroth's initial expert report did not address whether an ACL fits into a single CAM slice whereas his testimony at the hearing did. (*Id.*).

Cisco does not deny that Dr. Almeroth's expert report did not address whether an ACL fits into a single CAM slice and that his testimony about the same during the hearing was new. (*See* CBr.II at 51.). Therefore, Arista and Staff present a persuasive argument that Dr. Olivier's hearing testimony about testing is a fair rebuttal to new opinions by Dr. Almeroth. (*See* RRBr.II at 39; SRBr.II at 39). Cisco's motion is denied.

b) Arista's Motions to Strike

i. Arista's Motion to Strike 1

Arista moves to strike Cisco's expert Dr. Almeroth's hearing testimony regarding the infringement of claim 46 of the '853 patent as exceeding the scope of his expert reports and deposition testimony. (RBr.II at 42.). Arista asserted that Dr. Almeroth failed to identify in his

Public Version

expert report the relevant structures corresponding to the means-plus-function limitations of the claim. (*Id.* at 43-46.). Arista argued that Dr. Almeroth's reliance on more than 800 pages of claim charts did not meaningfully disclose his opinions regarding the infringing structures in Arista's products. (*Id.* at 46.). Staff supported Arista's motion in part for certain means-plus-function limitations and for certain products with respect to which Staff believed Dr. Almeroth's hearing testimony regarding claim 46 was well beyond the disclosures in his expert report. (SRBr.II at 40.).

Cisco opposed Arista's motion for several reasons. Cisco argued that: (1) Arista was contesting the mere sufficiency of Dr. Almeroth's testimony for showing infringement, which should not be a basis to strike the testimony; (2) Arista should have raised this issue earlier by questioning Dr. Almeroth during his deposition and raising an objection before the hearing; (3) Arista failed to show it was prejudiced; and (4) Arista's motion was overly broad because the testimony Arista seeks to strike concerns claim 1 of the '577 patent as well. (CRBr.II at 37-38.). Cisco contended that Dr. Almeroth's testimony was previously disclosed in his report. (*Id.* at 38-40.).

Dr. Almeroth's testimony at issue will not be stricken. Dr. Almeroth's expert report identified the structures in Arista's products that are accused of infringement. (CRBr.II at 38-40 (citing Almeroth Opening Rep. *passim.*)). To the extent Arista argued that the disclosures in Dr. Almeroth's expert report are insufficient to prove infringement of claim 46, whether Cisco met its burden of proving infringement will be addressed on the merits. The alleged insufficiency of expert opinion is no basis for striking it. Arista's complaints about Dr. Almeroth's lengthy claim charts is unpersuasive especially in view of Arista's own expert Dr. Olivier's reliance on claim charts. Experts may choose the format in which to disclose their opinions. Arista's motion is

denied.

ii. Arista's Motion to Strike 2

Arista moves to strike Cisco's expert Dr. Almeroth's hearing testimony regarding the infringement of claim 63 of the '853 patent (i.e., Tr. at 356:18-366:1 and CDX-2C-165 through 175). (RBr.II at 47-48.). Arista noted that the sections of Dr. Almeroth's expert report addressing the elements of claim 63 of the '853 patent simply refer to the *entire* analysis provided for claim 1 of the '577 patent. (*Id.*). Arista contended that there are substantial differences between the two claims and that Dr. Almeroth's report failed to account for these differences. (*Id.* at 48.). During the hearing, however, Dr. Almeroth explained that the evidence he relied upon for the step of "selecting an output interface" in claim 63 is the same as the evidence that he identified for the specific step of "making a routing decision" in claim 1. (*Id.* (citing Tr. (Almeroth) at 360:13-23).). He also linked during the hearing the steps of "determining forwarding permission" and "processing said packet" in claim 63 with the steps of "matching matchable information" and "generating an access result," respectively, in claim 1. (*Id.* (citing Tr. (Almeroth) at 361:15-24, 362:13-363:14).). Arista argued that Dr. Almeroth's hearing testimony that linked the elements of claim 63 with the elements of claim 1 is absent in Dr. Almeroth's expert report. (*Id.*). Staff supported Arista's motion and agreed with Arista that Dr. Almeroth's hearing testimony went beyond the scope of his expert reports and deposition testimony. (SRBr.II at 47.).

Cisco opposed Arista's motion. Cisco argued that there is a substantial overlap between the two claims, which justified Dr. Almeroth's expert report referencing the analysis provided for claim 1 of the '577 patent and for claim 63 of the '853 patent. (CRBr.II at 40.). Cisco also noted that Dr. Almeroth provided a supplemental expert report addressing claim 63. (*Id.*). Claim

Public Version

63 of the '853 patent and claim 1 of the '577 patent are method claims reciting multiple steps. (JX-3 at 12:20-33; JX-5 at 7:35-48.). Claim 63 comprises, among other things, the steps of “selecting an output interface,” “determining forwarding permission,” and “processing said packet.” (JX-3 at 12:20-33.). Claim 1 comprises, among other things, the steps of “maintaining . . . patterns,” “receiving a packet label,” “matching matchable information,” “selecting at least one of said matches,” and “making a routing decision.” (JX-5 at 7:35-48.). The two claims are not mirror images of each other, and therefore it is not readily apparent which steps of one claim correspond to which steps of the other claim. (*Compare* JX-3 at 12:20-33 *with* JX-5 at 7:35-48.). If Dr. Almeroth wished to rely upon the same evidence for the two claims based on perceived commonalities between the two sets of steps, he should have disclosed with specificity which evidence he intended to rely upon for each element of claim 63 by referring to the *specific* evidence he cited for claim 1. His expert reports, however, referred to the *entire* analysis of claim 1 for each step of claim 63. (*See* RBr.II at 47-48 (citing Almeroth Opening Rep. ¶¶ 824-30)). Such a vague and ambiguous disclosure left Arista and Staff to guess which particular steps of claim 63 Dr. Almeroth contended corresponded to which steps of claim 1. Although Dr. Almeroth provided the specific links during the hearing, his opinion should have been disclosed during discovery. Dr. Almeroth’s hearing testimony at issue (Tr. at 356:18–366:1) and relevant demonstratives (CDX-2C-165 through 175) are stricken, and Arista’s motion is granted.

iii. Arista’s Motion to Strike 3

Arista moved to strike Cisco’s expert Dr. Almeroth’s hearing testimony regarding the infringement of claim 2 of the '577 patent (i.e., Tr. at 366:2-370:6 and CDX-2C-159 through 162). (RBr.II at 49.). Arista argued that Dr. Almeroth’s expert report provides no analysis or discussion for dependent claim 2 but instead merely points to the analysis for independent claim

Public Version

1. (*Id.*). However, during the hearing, Dr. Almeroth testified that he relied on the same evidence for claim 2 of the '577 patent and claim 63 of the '853 patent. (*Id.* (citing Tr. (Almeroth) at 367:11–368:2).). Staff supported Arista's motion and agreed with Arista that the analysis for claim 2 in Dr. Almeroth's report relied solely on his discussion regarding claim 1. (SRBr.II at 47.).

Cisco argued that the sections of Dr. Almeroth's expert report with regard to claim 2 of the '577 patent and claim 63 of the '853 patent both reference the evidence relied upon for claim 1 of the '577 patent. (CRBr.II at 40.). Cisco appeared to argue that Dr. Almeroth's report linked claims 2 and 63 by their respective associations with claim 1. (*See id.*).

As discussed above in Section I.C.2.b.ii, the link between claim 63 of the '853 patent and claim 1 of the '577 in Dr. Almeroth's expert report was too vague to provide a fair notice of his opinions. Therefore, the indirect link between claim 2 of the '577 patent and claim 63 of the '863 patent, through their mutual associations with claim 1 of the '577 patent, is even more tenuous. Dr. Almeroth's hearing testimony at issue (Tr. at 366:2-370:6) and relevant demonstratives (CDX-2C-159 through 162) are stricken and Arista's motion is granted.

II. JURISDICTION AND IMPORTATION

To have the authority to decide a case, a court or agency must have both subject matter jurisdiction and jurisdiction over either the parties or the property involved. *See Certain Steel Rod Treating Apparatus and Components Thereof*, Inv. No. 337-TA-97, Commission Memorandum Opinion, 215 U.S.P.Q. 229, 231 (U.S.I.T.C. 1981). For the reasons discussed below, the facts support a finding that the Commission has jurisdiction over this Investigation.

A. Subject Matter Jurisdiction

Section 337 declares to be unlawful "[t]he importation into the United States, the sale for

Public Version

importation, or the sale within the United States after importation by the owner, importer, or consignee, of articles” that infringe a valid and enforceable United States patent if an industry relating to the articles protected by the patent exists or is in the process of being established in the United States. *See* 19 U.S.C. §§ 1337(a)(1)(B)(i) and (a)(2). Pursuant to Section 337, the Commission investigates alleged violations of the Section and hears and decides actions involving those alleged violations.

With respect to the asserted patents, Arista concedes that the Commission has subject matter jurisdiction over Arista and the subject matter of this Investigation. (RBr. at 17.). Arista sells for importation, imports, or sells after importation into the United States, articles that are accused in this Investigation. *See Certain Electronic Devices with Image Processing Systems, Components Thereof, and Associated Software*, Inv. No. 337-TA-724, Comm’n Op. at 9-10 (U.S.I.T.C., Dec. 21, 2011¹²).

B. Personal Jurisdiction

Arista responded to the Complaint and Notice of Investigation and has fully participated in the Investigation by, among other things, participating in discovery, participating in the *Markman*, and filing pre-hearing and post-hearing briefs. Arista does not contest jurisdiction. (RBr. at 17.). Accordingly, Arista has submitted to the personal jurisdiction of the Commission and that the Commission has *in rem* jurisdiction over Arista and the Accused Products. *Certain Cloisonné Jewelry*, Inv. No. 337-TA-195, Initial Determination at 40-43 (U.S.I.T.C., March 1985) (unreviewed).

¹² Date of public opinion.

C. In Rem Jurisdiction and Importation

1. Importation of the Accused Products

The Commission has *in rem* jurisdiction over infringing articles that are imported into the United States, sold for importation, or sold within the United States after importation by the owner, importer, or consignee. 19 C.F.R. § 1337(a)(1)(B). A complainant need only establish the importation of a single accused product to satisfy the importation requirement of Section 337. *See, e.g., Certain Trolley Wheel Assemblies*, Inv. No. 337-TA-161, Comm'n Op. at 7-8, USITC Pub. No. 1605 (Nov. 1984) (finding the importation requirement met by the importation of a single product); *Certain Absorbent Garments*, Inv. No. 337-TA-508, Order No. 16, 2004 WL 2251882, at *2 (U.S.I.T.C. Aug. 20, 2004).

Arista asserts that there cannot be direct infringement of the '668 patent at the time of importation because the EOS software is not loaded on the Blank Switches¹³ and Imported Components¹⁴ at the time of importation. (*See, e.g., CX-0732C* at 15-18 (Arista's Fourth Supplemental Responses and Objections to Interrog.; Tr. (Metivier) at 2067:16–2069:23; JX-0033C at 62:1-5; JX-0027C at 34:10-16).

It is a finding of this Initial Determination that the weight of the evidence supports a finding that the accused devices included the EOS software at the time of importation when the Complaint giving rise to this Investigation was filed. (*See, e.g., CX-0732C*; Tr. (Metivier) at

¹³ In its briefing, Arista referred to "Arista's switches and supervisor modules without EOS loaded at the time of importation" as "Blank Switches." (RBr. at 10; RPBr. at 12-13.).

¹⁴ In its briefing, Arista referred to "network switch hardware" that was imported separately from the switches into the United States, which include "power supplies, fans, chassis, and printed circuit boards (PCBs)" as "Imported Components." (RBr. at 10-11; RPBr. at 13.).

2073:19–2075:15, 2087:9-12.). For instance, Mr. Christophe Metivier¹⁵ stated that Arista had

[

] alone is sufficient to establish direct infringement at the time of importation. *See, e.g., Certain Trolley Wheel Assemblies*, Inv. No. 337-TA-161, Comm’n Op. at 7-8, USITC Pub. No. 1605 (Nov. 1984). Accordingly, the Commission has *in rem* jurisdiction over the accused products pursuant to 19 U.S.C. § 1337(a). *See Sealed Air Corp. v. U. S. Int’l Trade Comm’n*, 645 F.2d 976, 985 (C.C.P.A. 1981).

2. Importation of Hardware Components

The Commission has *in rem* jurisdiction over “articles that infringe” a valid and enforceable United States patent,” which include components used in, or are otherwise a part of, induced and/or contributory infringement under 35 U.S.C. § 271(b) and (c). 19 U.S.C. 1337(a)(1)(B).

By using the word “infringe,” Section 337 refers to 35 U.S.C. § 271, the statutory provision defining patent infringement. The word “infringe” does not narrow Section 337’s scope to any particular subsections of § 271. As reflected in § 271 and the case law from before and after 1952, “infringement” is a term that encompasses both direct and indirect infringement, including infringement by importation that induces direct infringement of a method claim.

Suprema, Inc. v. Int’l Trade Comm’n, 796 F.3d 1338, 1346 (Fed. Cir. 2015) (en banc) (citations omitted); *Certain Digital Media Devices Including Televisions, Blu-Ray Disc Players, Home Theater Sys., Tablets & Mobile Phones, Components Thereof * Assoc. Software*, Inv. No. 337-TA-882, Final Initial Determination (Aug. 7, 2014) (“*Certain Digital Media Devices*”). Thus,

¹⁵ At the time of his testimony, Mr. Christophe Metivier (“Mr. Metivier”) was the Vice President of Manufacturing and Platform Engineering at Arista. (JX.033C at 7:17-19.). Arista designated Mr. Metivier as a fact witness to provide testimony regarding the manufacture, assembly, and importation of the accused products and components thereof. (RPS. at 3.).

the Commission has jurisdiction over articles that induce or contribute to direct infringement, even if direct infringement takes place post-importation. *Id.* at 1352; *Certain Digital Media Devices* at 22-23.

The weight of the evidence supports a finding that Arista imports the switch hardware used in the accused products into the United States. (*See, e.g.*, CX-0732C at 13; Tr. (Metivier) at 2066:4-16.). Arista switch hardware used in the accused products induces and contributes to direct infringement of the asserted patents because it is designed and used only to load EOS software, the combination of which constitutes the infringing accused products. (*See, e.g.*, Tr. (Metivier) 2079:24–2080:3; JX-0025C at 204:23-25, 205:5-8, 266:8-15, 267:1–268:12, 273:19–275:15; JX-0049C at 140:20–141:4; CX-0069C.).

Therefore, the Commission has *in rem* jurisdiction over the switch hardware because they constitute “articles that infringe” under Section 337 and the Federal Circuit’s en banc holding in *Suprema*. *Suprema*, 796 F.3d at 1343.

D. Ownership of the Asserted Patents and Standing

The asserted patents have each been assigned to Cisco, and the assignments have been recorded with the U.S. Patent and Trademark Office. (*See* JX-0013; JX-0014; JX-0015; JX-0016; JX-0017; JX-0018.). Therefore, Cisco has standing to bring this action against Arista.

III. The Asserted Patents

A. Overview of the Technology

The technology at issue in this Investigation relates to networking equipment, such as switches, as well as software and components within the switches. (Compl. at ¶¶ 14-15.).

B. U.S. Patent No. 6,377,577 (“’577 Patent”)

1. Overview of the ’577 Patent

This Investigation concerns U.S. Patent No. 6,377,577, “Access Control List Processing in Hardware,” which resulted from U.S. Patent Application No. 09/108,071 filed on June 30, 1998. (JX-0005.). The ’577 patent issued on April 23, 2002, and names Andreas V. Bechtolsheim¹⁶ and David R. Cheriton¹⁷ as the inventors. (*Id.*). The ’577 patent was assigned from the named inventors to Cisco. (Compl. at 4, Exs. 7-8.).

A network device,¹⁸ such as a router, in a computer network may implement access control by restricting the transmission of information from a certain sender to a certain destination. (JX-0005 at 1:4-8.). One technique for implementing access control involves preparing an access control list (ACL). An ACL includes one or more entries of access control specifiers. As the name indicates, an access control specifier specifies whether the transmission of information is permitted or prohibited from a certain sender (or a range of senders) to a certain destination (or a range of destinations, such as a subnetwork). (*Id.* at 1:10-15.). For example, an access control specifier may specify an Internet Protocol address of a sender or destination, a prefix or subnet address for a group of senders or destinations, or a port number used by the sender or the destination to transmit information. (*Id.* at 1:15-20.). To implement access control,

¹⁶ At the time of his testimony, Mr. Andreas Bechtolsheim (“Mr. Bechtolsheim”) was Arista’s Chief Development Officer and Chairman of the Board. (JX-0021C at 44:15–45:2.). Arista designated Mr. Bechtolsheim as a fact witness to provide testimony with regard to: (1) the conception, development, reduction to practice, inventorship, and prior art related to the ’577 and ’853 patents; (2) the industry use of TCAMs for ACLs (*see infra* Section V.B.1) and Cisco’s knowledge of this use; and (3) any interactions between Cisco and Arista. (RPSt. at 2.).

¹⁷ Dr. David Cheriton (“Dr. Cheriton”) was a member of Arista’s board of directors and served as Arista’s Chief Scientist from October 2004 to March 1, 2014. (JX-0023C at 46:3-8, 73:14-17.).

¹⁸ Network devices can include routers, switches, and firewalls. (*See, e.g.*, JX-2 at 1:6-7.).

Public Version

an ACL is provided to a network device, such as a router. (*Id.* at 1:23-27.). As packets¹⁹ of information arrive at a router for transmission, the router checks the packets against the access control specifiers that were provided in the ACL to determine whether the sender of the packet and the destination of the packet are permitted based on the access control specifiers. (*Id.* at 1:6-10.). If permitted, the router forwards the packet to the appropriate output for transmission to the destination. (*Id.* at 1:6-15.). If prohibited, the router denies transmission of the packet. (*Id.* at 1:4-6.).

The '577 patent recognizes that the prior art implementations of processing packets to enforce access control according to an ACL is slow and processor-intensive. (*Id.* at 1:28-32.). The slowness is exacerbated when access control is implemented using software processing instead of hardware processing. (*Id.* at 1:32-35.). Moreover, if the ACL includes numerous entries of access control specifiers, such as when the requirements for access control are complex, more time is required to process the access control specifiers for each packet. (*Id.* at 2:9-17.). For example, wires in computer networks can transmit about 1.5 million to hundreds of millions of packets per second. (*Id.* at 2:20-24.). It would be desirable for routers to process packets at these rates. (*Id.* at 2:24-25.). However, the speed at which routers can implement access control based on large ACLs can be as slow as about 10,000 packets per second. (*Id.* at 2:18-19.). Such speeds are unacceptably low. (*Id.* at 2:25-26.).

To address the slowness problem, the '577 patent teaches hardware processing of ACLs, which is faster than software processing, and teaches processing the access control specifiers in parallel, which is faster than sequential processing. (*Id.* at 2:7-29, 7:40-44.). First, access

¹⁹ Messages exchanged in a computer network are in the form of packets of information. (JX-0005 at 1:6-10.). A packet includes a header containing the identifications of the source device and the destination device. (*Id.* at 2:41-43, 4:1-4, fig. 2.).

Public Version

control specifiers from an ACL are recorded in a content-addressable memory (CAM) of a router. (*Id.* at 2:29-32, 40-41.). When a packet arrives at the router, it extracts certain information from the header, such as the source IP address, the destination IP address, and the port number. (*Id.* at 2:33-34, 41-43.). Then the router attempts to match the packet header information to all the access control specifiers stored in the CAM in parallel. (*Id.* at 2:34-35, 43-44, 7:40-42.). One or more successful matches are sent to a priority selector, which selects the match with the highest priority, and the selected match determines whether to permit or deny the transmission of the packet. (*Id.* at 2:44-49.). These steps are performed in hardware without the need for software processing, thus increasing the speed at which access control is enforced. (*Id.* at 2:28-30, 38-40, 49-50.).

2. The Asserted Claims

Remaining asserted claims 1-2, 7, 9-10, and 15 of the '577 patent are recited below. The referenced claims are method claims that recite steps for making a routing decision for a packet by matching in parallel a packet label derived from the packet with access control patterns stored in memory.

1. A method, including the steps of maintaining a set of access control patterns in at least one associative memory;
 - receiving a packet label responsive to a packet, said packet label being sufficient to perform access control processing for said packet;
 - matching matchable information, said matchable information being responsive to said packet label, with said set of access control patterns in parallel, and generating a set of matches in response thereto, each said match having priority information associated therewith;
 - selecting at least one of said matches in response to said priority information, and generating an access result in response to said at least one selected match; and
 - making a routing-decision in response to said access result.

Public Version

3. A method of as in claim 1, including the step of performing at least two of said steps of receiving, matching, selecting, and making a routing decision, in parallel using a pipeline technique.

7. A method as in claim 1, wherein said associate memory includes a ternary content-associative memory.

9. A method as in claim 1, wherein said priority information for each said access control pattern is responsive to a position of said access control pattern in a memory.

10. A method as in claim 1, wherein said priority information includes a position in said associative memory, and said step of selecting includes choosing a first one of said matches.

15. A method as in claim 1, wherein said routing decision includes permitting or denying access for said packet.

(JX-5 at 7:34-8:28.).

C. U.S. Patent No. 7,023,853 (“’853 Patent”)

1. Overview of the ’853 Patent

This Investigation concerns U.S. Patent No. 7,023,853, “Access Control List Processing Hardware,” which resulted from U.S. Patent Application No. 10/087,342 filed on March 1, 2002. (JX-0003.). The ’853 patent is a continuation of U.S. Application No. 09/108,071 filed on June 30, 1998, which issued as U.S. Patent No. 6,377,577. (*Id.*). The ’853 patent issued on April 4, 2006 and names Andreas V. Bechtolsheim and David R. Cheriton as the inventors. (*Id.*). The ’853 patent was assigned from the named inventors to Cisco. (Compl. at 4, Exs. 7-8.).

The ’853 patent shares a common specification with the parent ’577 patent. (JX-0003; JX-0005.). The claims of the ’853 patent are directed to systems as well as methods.

2. The Asserted Claims

Remaining asserted claims 46 and 63 of the ’853 patent are recited below. Claim 46 is directed to a system that includes several means for performing the same steps recited in method

Public Version

claim 1 of the '577 patent. Claim 63 is directed to a method that includes the steps of selecting an output to which a packet should be forwarded and in parallel determining whether forwarding the packet is permitted by matching the access control specifiers with characteristics of the packet.

46. A system comprising:

means for maintaining a set of access control patterns in at least one associative memory;

means for receiving a packet label responsive to a packet, said packet label being sufficient to perform access control processing for said packet;

means for matching matchable information, said matchable information being responsive to said packet label, with said set of access control patterns in parallel;

means for generating a set of matches in response thereto, each said match having priority information associated therewith;

means for selecting at least one of said matches in response to said priority information, and generating an access result in response to said at least one selected match; and

means for making a routing decision in response to said access result.

63. A method of processing a packet comprising:

selecting an output interface to which to forward the packet;

determining forwarding permission for the packet, wherein the determining comprises

matching one or more characteristics of said packet with one or more access control specifiers in at least one access control element;

processing said packet based on said forwarding permission;

wherein, the selecting step is performed in parallel with the determining step.

(JX-3 at 10:47-12:34.).

D. U.S. Patent No. 7,061,875 (“’875 Patent”)

1. Overview of the ’875 Patent

This Investigation concerns U.S. Patent No. 7,061,875, “Spanning Tree Loop Guard,” which resulted from U.S. Patent Application No. 10/020,667 filed on December 7, 2001. (JX-0004.). The ’875 patent issued on June 13, 2006 and names Maurizio Portolani, Shyamasundar S. Kaluve,²⁰ and Marco E. Foschiano as inventors. (*Id.*). The ’875 patent was assigned from the named inventors to Cisco. (Compl. at 4, Ex. 10.).

A network typically comprises multiple computers that are interconnected. (JX-0003 at 1:10-11.). Multiple networks may be interconnected by network devices, such as switches²¹ and bridges.²² (*Id.* at 1:20-31.). Network devices comprise ports²³ that connect the network devices to networks and to computers. (*Id.* at 1:31-33.). Therefore, a network device that receives data from a source port connected to a source computer forwards the data to a destination port connected to a destination computer. (*Id.* at 1:33-36.). Network devices typically learn which destination port to use to reach a particular computer by noting which source port last received data from the computer and saving that information. (*Id.* at 1:37-40.). If a network device does not know which port to use to reach a particular computer, the network device broadcasts the data by sending copies of the data out to all ports, except the port on which the data was

²⁰ At the time of his testimony, Mr. Shyamasunder Kaluve (“Mr. Kaluve”) was a director of software development at Cisco. (*See, e.g.*, JX-0050C at 17:19-22.). Cisco designated Mr. Kaluve as a fact witness to provide testimony with regard to: (1) the invention and validity of the ’853 and ’577 patents; and (2) Cisco’s domestic industry activities and products related thereto. (CPSt. at 3.).

²¹ A switch transfers information between a plurality of networks and computers. (JX-0006 at 1:37-39.).

²² A bridge connects (i.e., bridges) multiple networks. (JX-0006 at 1:35-36.).

²³ A port is an interface on switches and bridges that enable them to be connected to other switches, bridges, or computers. (JX-0006 at 1:39-41.).

received. (*Id.* at 1:45-49.).

Networks often include multiple communication paths that connect one computer to another. (*Id.* at 1:50-51.). These redundant communication paths allow computers to continue to communicate even if a network device or a link fails. (*Id.* at 1:51-53.). However, the existence of redundant communication paths can create undesirable circular paths (i.e., loops). (*Id.* at 1:53-55.). Loops are problematic because data may traverse loops indefinitely. (*Id.* at 1:55-57.). Additionally, since network devices often replicate data when broadcasting it out to all ports, loops can cause tremendous proliferation of the data that overwhelms the networks. (*Id.* at 1:57-62.).

To avoid the problems caused by loops, network devices execute what is called a spanning tree protocol (“STP”) that determines a network topology that connects (i.e., spans) each network device but is loop-free (i.e., a tree). (*Id.* at 1:63-2:1.). To use the STP, bridges in a network exchange bridge protocol data unit (BPDU) messages.²⁴ (*Id.* at 25-27.). The BPDU messages allow the bridges to select a single bridge as the root bridge and determine the costs associated with various paths to the root bridge. (*Id.* at 2:5-7, 30-39.). Based on the exchanged BPDU messages, each non-root bridge selects one of its ports as the root port (providing the least cost path to the root bridge) and other designated ports for inclusion in the active spanning tree topology. (*Id.* at 2:14-17.). The root ports and bridge ports are placed in a forwarding state so that data may be forwarded to and from these ports and thus forming the active tree (loop-free) topology of the network. (*Id.* at 2:17-20.). Ports associated with redundant paths are not included in the active topology and are placed in a blocking state so that data will not be

²⁴ “BPDU” is an acronym for “Bridge Protocol Data Units.” (CX-0221 at CSI-ANI-00128383.000953.). BPDUs are STP information packets that bridges exchange. (*Id.*)

Public Version

forwarded to or received from these ports. (*Id.* at 2:20-23.). Bridges continuously exchange BPDU messages in order to adapt the active topology to failures or changes in link costs. (*Id.* at 2:43-45.). Changes to the active topology are implemented by transitioning the ports between the forwarding state and the blocking state. (*Id.* at 2:63-66.). For instance, a port in a so-called “block state” may transition to a “listening state” based on information in a new BPDU message. (*Id.* at 2:66-3:5.). In the listening state, the port waits for information indicating that it should return to the blocking state. (*Id.* at 3:5-7.). If the port in the listening state receives no such information by a preset period of time, the port transitions to the learning state. (*Id.* at 3:7-8.). In the learning state, the port still does not forward data but saves information associating the port with the source computers sending data to the port so that the information can be used to send data to those computers in the future. (*Id.* at 3:8-12.). At the end of a second preset period of time, the port transitions from the learning state to the forwarding state. (*Id.* at 3:12-15.).

The STP, however, is not flawless. For example, if a duplex link connecting two bridges has a partial failure such that data transmission in one direction stops but data transmission in the other direction continues, loops can form that are undetectable by the STP. (*Id.* at 4:11-17.). Additionally, certain hardware or software errors in the bridges running the STP can create undetectable loops. (*Id.* at 4:41-5:1.).

To prevent formation of loops that are undetectable by the STP, the '875 patent discloses a loop guard engine in network devices and a new port state called the “loop inconsistent state.” (*Id.* at 5:20-31.). The loop guard engine is in communication with the spanning tree protocol engine and the ports, and monitors the receipt of BPDU messages by the ports. (*Id.* at 5:20-25.). If a port stops receiving BPDU messages, the loop guard engine transitions the port to the loop inconsistent state, thereby preventing the STP engine from transitioning the port to the

forwarding state. (*Id.* at 5:25-31.). The port in the loop inconsistent state is precluded from forwarding or receiving data. (*Id.* at 5:31-33.). If the port subsequently receives a BPDU message, the loop guard engine releases the port and allows the port to be transitioned to one of the STP states. (*Id.* at 5:34-37.).

2. The Asserted Claims

Remaining asserted claims 1-4 and 10 of the '875 patent are recited below.

1. In an intermediate network device having a plurality of ports for forwarding network messages within a bridged network, a method for preventing the formation of loops within the bridged network, the method comprising the steps of:

executing a spanning tree protocol (STP) at the intermediate network device so as to elect a root of the bridged network and to transition at least one of the device's ports among a plurality of spanning tree port states, including a discarding state, a listening state and a forwarding state;

periodically receiving configuration bridge protocol data unit (BPDU) messages at one or more of the device's ports;

in response to the periodic receipt of BPDU messages being stopped on a given port, (1) preventing the given port from transitioning to the forwarding spanning tree port state, if the given port is in a spanning tree port state other than the forwarding spanning tree port state, or (2) precluding the given port from forwarding or receiving network messages, if the given port is in the forwarding spanning tree port state.

2. The method of claim 1 wherein the spanning tree port states further include a loop inconsistent spanning tree port state, and the method further comprises the step of placing the given port that stopped receiving BPDU messages in the loop inconsistent spanning tree port state.

3. The method of claim 2 wherein a port in the loop inconsistent state is precluded from transitioning to another spanning tree port state and from forwarding or receiving network messages.

4. The method of claim 2 further comprising the steps of:

releasing the given port from the loop inconsistent spanning tree port state, in response to a BPDU message once again being received on the given port; and

Public Version

transitioning the given port from the loop inconsistent spanning tree port state to another spanning tree port state.

10. An intermediate network device configured to receive and forward network messages within a bridged network, the device having a plurality of ports for connecting the device to one or more network entities or other devices, the intermediate network device comprising:

a spanning tree protocol (STP) engine configured and arranged to elect a root of the bridged network and to transition at least some of the device's ports among a plurality of spanning tree port states, including a discarding or blocking state, a listening state and a forwarding state; and

a loop guard engine cooperating with the STP engine, wherein configuration bridge protocol data unit (BPDU) messages are periodically received at one or more of the device's ports, and

in response to the periodic receipt of BPDU messages being stopped on a given port, the loop guard engine (1) prevents the given port from transitioning to the forwarding spanning tree port state, if the given port is in a spanning tree port state other than the forwarding spanning tree port state, or (2) precludes the given port from forwarding or receiving network messages.

(JX-0004 at 13:5-14:23.).

E. U.S. Patent No. 7,460,492 (“’492 Patent”)

1. Overview of the ’492 Patent

This Investigation also concerns U.S. Patent No. 7,460,492, “Spanning Tree Loop Guard,” which resulted from U.S. Patent Application No. 11/451,888 filed on June 12, 2006.

(JX-0006.). The ’492 patent is a continuation of U.S. Patent Application No. 10/020,667, which was filed on December 7, 2001, and which issued as the ’875 patent. (*Id.*). The ’492 patent issued on December 2, 2008, and names Maurizio Portolani, Shyamasundar S. Kaluve, and Marco E. Foschiano as the inventors. (*Id.*). The ’492 patent was assigned from the named inventors to Cisco. (Compl. at 4, Ex. 9.).

The ’492 patent shares a common specification with the parent ’875 patent. (JX-0004;

Public Version

JX-0006.). The asserted claims of the '492 patent are directed to network devices that implement a rapid spanning tree protocol (RSTP). The RSTP uses a different set of port states from the STP and allows faster adjustments to the active topology. (*Id.* at 3:36-4:8.).

2. The Asserted Claims

Remaining asserted claims 1 and 3-4 of the '492 patent are recited below.

1. An intermediate network device configured to receive and forward network messages, the intermediate network device having a plurality of ports to connect the intermediate network device to one or more other devices, the intermediate network device comprising:

one or more processing elements configured to execute a spanning tree protocol engine, the spanning tree protocol engine to implement a Rapid Spanning Tree Protocol (RSTP) to transition at least some of the intermediate network device's ports among a plurality of port states, including a discarding port state, a listening port state, and a forwarding port state; and

the one or more processing elements further configured to execute a loop guard engine, the loop guard engine to cooperate with the spanning tree protocol engine, the loop guard engine configured to, in response to a stoppage of a periodic receipt of bridge protocol data units (BPDUs) on a given port, prevent the given port from transitioning to the forwarding port state, if the given port is in a port state other than the forwarding port state.

3. The intermediate network device of claim 1 wherein the plurality of port states further include a loop inconsistent port state, and the loop guard engine is further configured to cause the given port to be transitioned to the loop inconsistent port state.

4. The intermediate network device of claim 3 wherein the loop guard engine is further configured to cause the given port to be released from the loop inconsistent port state in response to receipt of a BPDU on the given port.

(JX-0006 at 13:5-39.).

F. U.S. Patent No. 7,224,668 (“’668 Patent”)

1. Overview of the ’668 Patent

This Investigation concerns U.S. Patent No. 7,224,668, “Control Plane Security and

Public Version

Traffic Flow Management,” which resulted from U.S. Patent Application No. 10/307,154 filed on November 27, 2002. (JX-0002.). The ’668 patent issued on May 29, 2007, and names Adrian C. Smethurst, Michael F. Keohane,²⁵ R. Wayne Ogozaly as the inventors. (*Id.*). The ’668 patent was assigned from the named inventors to Cisco. (Compl. at 4, Ex. 11.).

Routers and other network devices that make up the Internet and private networks are critical to the operation of many organizations. (JX-0002 at 1:5-9.). As such, a router is susceptible to denial-of-service (DoS) attacks, in which perpetrators flood the target router with extraordinarily high rate of data traffic, thereby clogging the router’s ports, depleting the router’s resources, impeding the router’s ability to provide services for its intended purposes, and causing the router to fail. (*Id.* at 1:30-51.).

A router typically separates its functionality into two parts: the data plane functions and the control plane functions. (*Id.* at 1:52-54.). The data plane is principally responsible for receiving packets of data at input ports and routing the packets to appropriate output ports. (*Id.* at 1:54-56.). The control plane is responsible for higher layer functions, such as establishing routing tables and entering quality service policies. (*Id.* at 1:56-59.). Therefore, DoS attacks are commonly directed at the control plane service functions since their failure is most likely to cause widespread disruptions. (*Id.* at 1:59-63.).

To defend against DoS attacks, administrators can create policies that filter packets arriving from known mischievous sources, deny specific problematic packet types, or throttle the rate of specific packet types to limit the rate at which such packets are sent from the data plane to

²⁵ At the time of his testimony, Mr. Michael Keohane (“Mr. Keohane”) was a principal engineer at Cisco. (JX-0056C at 7:13-16.). Cisco designated Mr. Keohane as a fact witness to provide testimony with regard to: (1) the invention and validity of the ’668 patent; (2) Cisco’s domestic industry activities and products related thereto. (CPSl. at 3.).

Public Version

the control plane. (*Id.* at 2:24-39.). However, these solutions have drawbacks. There remain packet types for which these policies do not provide control plane protection. (*Id.* at 2:45-49.). Moreover, these policies need to be maintained and deployed to every interface in a network, which is not feasible because even a modest network may contain hundreds or thousands of interfaces. (*Id.* at 2:50-58.). Also, applying these policies at the input ports (and thus to control-plane destined packets as well as non-control plane traffic) causes significant performance reduction of the router, because a port would be forced to execute the policies for every packet it receives. (*Id.* at 2:59-3:2.).

The '668 patent discloses an improved technique for defending against DoS attacks. (*Id.* at 3:18-21.). The patent discloses a single control plane port, which is independent of the physical ports from which packets are received, through which control plane port services may be applied to packets sent to the control plane port. (*Id.* at 3:43-58.). Figure 1 of the '668 patent below includes an internetworking device **100** and shows the control plane port **140** leading to the control plane **150** at the top of the figure.

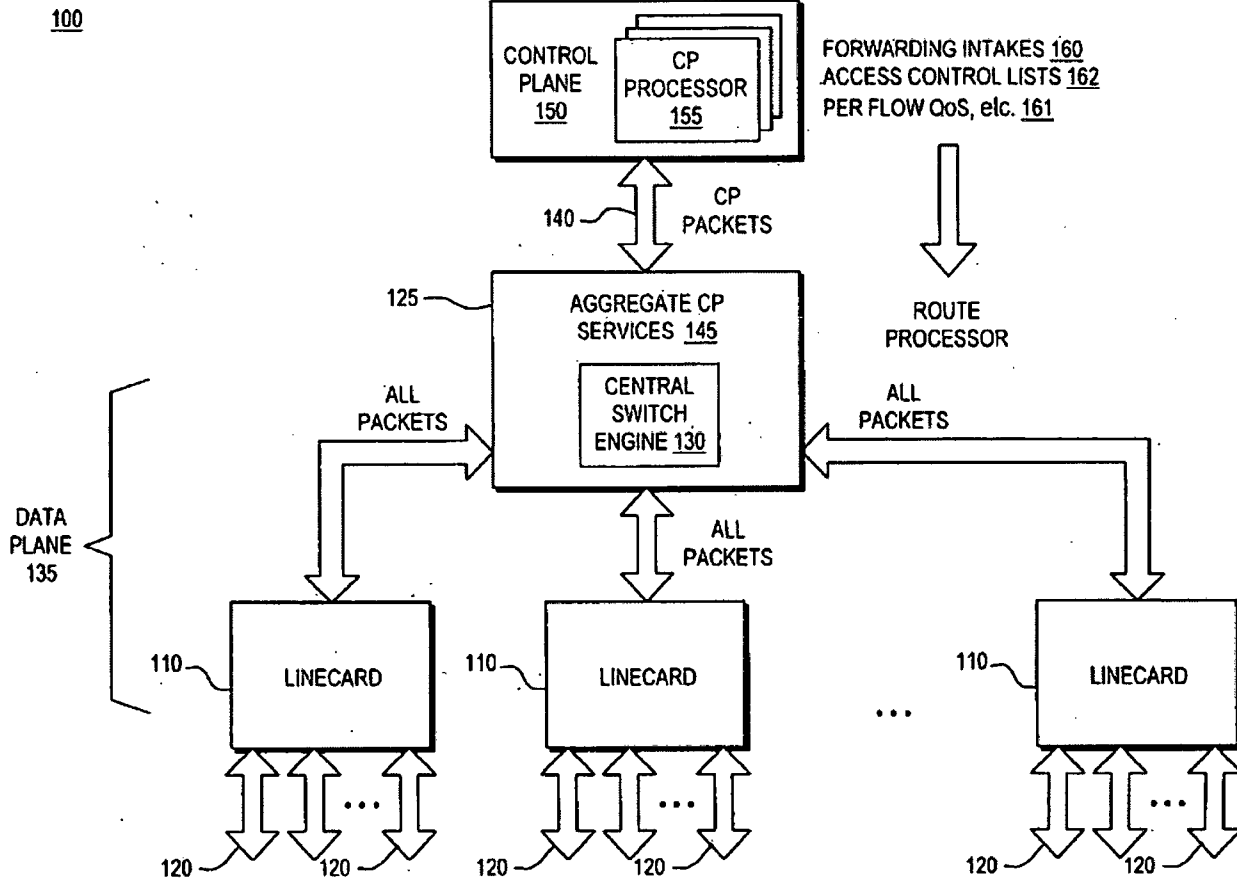

FIG. 1

Fig. 1 of '668 Patent

(*Id.* fig. 1.). In accordance with the invention, control plane processes have been collectively arranged as a single addressable entity. (*Id.* at 3:44-47.). Therefore, packets that would have been destined to specific control plane processes are now destined to the single control plane port. (*Id.* at 3:48-54.). As a result, administrators can apply a set of control plane services to the single control plane port (which would affect packets entering and exiting each of the control plane processes) rather than modifying the configurations of all ports. (*Id.* at 3:54-58, 4:5-12.).

2. The Asserted Claims

Remaining asserted claims 1-2, 4-5, 7-8, 10, 13, 18, 56, and 64 of the '668 patent are recited below.

1. An internetworking device comprising:
 - a. a plurality of physical network interface ports, each for providing a physical connection point to a network for the internetworking device, the ports being configurable by control plane processes;
 - b. port services, for operating on packets entering and exiting the physical network interface ports, the port services providing an ability to control and monitor packet flows, as defined by control plane configurations;
 - c. a control plane, comprising a plurality of internetworking control plane processes, the control plane processes for providing high-level control and configuration of the ports and the port services;
 - d. wherein:
 - i. a control plane port entity provides access to the collection of control plane processes, so that a set of control plane port services can be applied thereto; and
 - ii. the control plane port services operate on packets received from specific, predetermined physical ports and destined to the collection of control plane processes in a way that is independent of the physical port interfaces and services applied thereto.

2. A device as in claim 1 wherein the control plane processes are accessible through a control plane port on the internetworking device, such that control plane packets originating at a plurality of physical ports and destined to one of a plurality of control plane processes are first processed through the control plane port, rather than to individual control plane processes.

4. A device as in claim 3 wherein the control plane port services are applied after a transit packet forwarding decision is made.

5. A device as in claim 3 wherein Layer 2 control packets are identified and forwarded to the control plane port.

7. A device as in claim 1 wherein the control plane processes are distributed across multiple processors.

Public Version

8. A device as in claim 1 wherein the control plane port services are implemented as an aggregate control plane function applied to packets received from multiple physical ports on the internetworking device.

10. A device as in claim 1 wherein the control plane port services are implemented as distributed control plane port services, and wherein the distributed control plane port services are applied only to the packets received from the specific, pre-determined physical ports.

13. A device as in claim 10 wherein one or more distributed switch engines deliver packets to the control plane port.

18. A device as in claim 1 where in control plane port services are controlled and configured as unique entity, separate from physical port services.

56. A medium as in claim 55 wherein the control plane port processes packets originating at a plurality of physical ports, the method additionally comprising:

passing packets through the control plane port, rather than directly from the physical ports to individual control plane processes.

64. A medium as in claim 55 additionally comprising:

applying distributed control plane port services only to the packets received from the specific, pre-determined physical ports.

(JX-2 at 9:18-14:17.).

G. U.S. Patent No. 8,051,211 (“’211 Patent”)

1. Overview of the ’211 Patent

This Investigation concerns U.S. Patent No. 8,051,211, “Multi-Bridge LAN Aggregation,” which resulted from U.S. Patent Application No. 10/282,438 filed on October 29, 2002. (JX-0001.). The ’211 patent issued on November 1, 2011, and names Norman W. Finn as the inventor. (*Id.*). The ’211 patent was assigned from the named inventor to Cisco. (Compl. at 4, Ex. 12.).

Public Version

A LAN²⁶ connects multiple computers in a way that allows information to be exchanged among the computers. (JX-0001 at 1:11-13.). Multiple LANs may be connected together with bridges to create a bridged LAN so that computers in one LAN can communicate with computers in other LANs. (*Id.* at 1:29-33.). It is desirable to have redundant LAN connections so that if, for example, one LAN fails, another LAN is available for communication. (*Id.* at 1:65-2:14.).

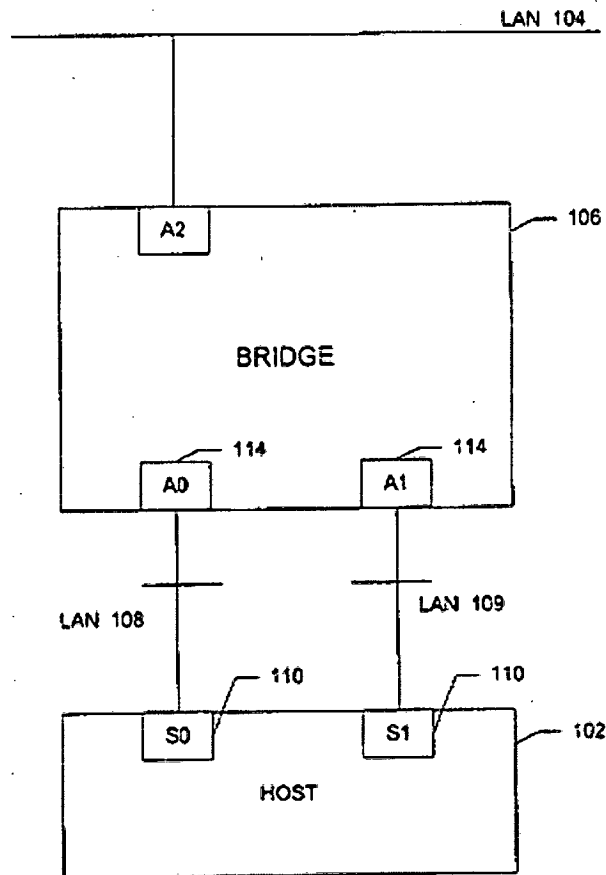

Fig. 1 of '211 Patent

As illustration, Figure 1 of the '211 patent shows host 102 connected to LAN 104 via bridge 106 connected by two LANs 108 and 109. (*Id.* at 2:5-12, Fig. 1.). Therefore, if either

²⁶ LAN is an acronym for Local Area Network. This literal translation of "LAN" is not intended to undermine the parties' agreed construction for "LAN" as it is used in certain of the '211 patent claims.

Public Version

LAN **108** or LAN **109** fails, the other LAN is available for host **102** to stay connected to LAN **104**. (*Id.* at 2:12-14.). Unfortunately, network interfaces **110** of host **102** is each associated with a unique internet protocol (IP) address. (*Id.* at 2:15-18.). Having a single host associated with multiple IP addresses is disadvantageous for a number of reasons, including confusion, inefficiency, and slowness. (*Id.* at 2:15-27.).

To overcome these disadvantages, the '211 patent describes a method of aggregating a plurality of LANs coupling a host to two bridges that include a tunnel engine. (*Id.* at 3:36-45.). For example, with respect to Figure 3B of the '211 patent shown below, host **356** is connected to LAN **310** via interface **360** connected to bridge **342** and interface **360** connected to bridge **344**. (*Id.* at 5:46-47.). The two interfaces **360** are configured as a single virtual interface **362** having only one IP address. (*Id.* at 5:47-50.). Bridge **342** and bridge **344** are coupled together via inter-bridge link **364**. (*Id.* at 5:42-45.). In accordance with the invention, bridge **342** is configured to internally transmit data between bridge-interconnect port **366** and port **A0** directly without any examination, essentially tunneling a pass-through path **353**. (*Id.* at 5:50-6:4, Fig. 3B.). Therefore, bridge **342** is essentially transparent to bridge **344** and host **356**. (*Id.* at 6:3-4.). Moreover, link aggregation is configured in bridge **344** for port **B0** and bridge-interconnect port **366**. (*Id.* at 6:5-7.). Therefore, host **356** has two paths to LAN **310**, one via LAN **314** and the other via LAN **312** and pass-through path **353**. (*Id.* at 6:10-13.).

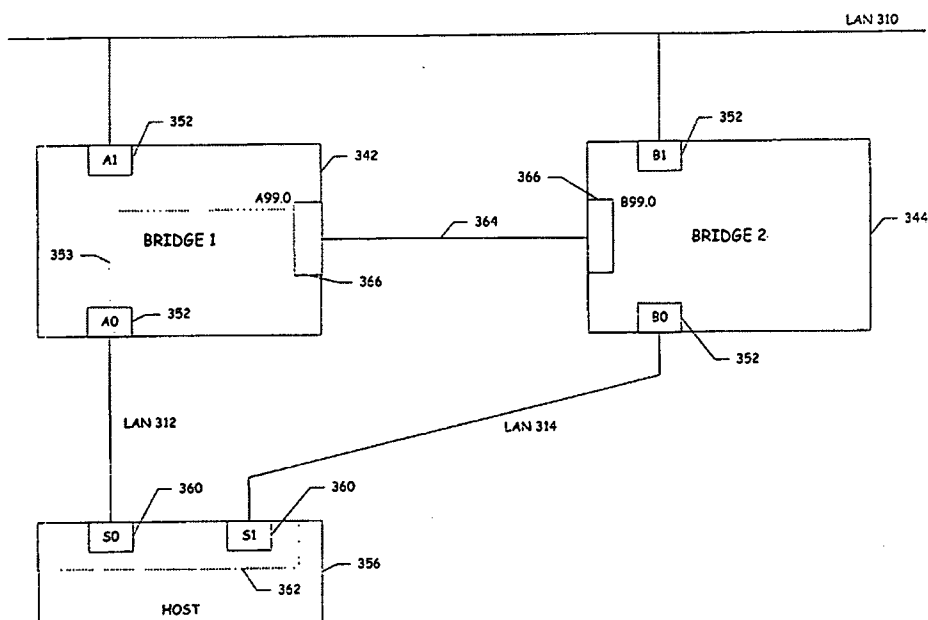

Figure 3B

Fig. 3B of '211 Patent

If LAN 312, bridge 342, or inter-bridge link 364 fails, host 356 would shift all communications to LAN 314 and bridge 344. (*Id.* at 6:21-24.). If LAN 314 or bridge 344 fails, bridge 342 would discard the pass-through path 353 and the use of bridge-interconnect port 366, and reconfigure port A0 as a normal port. (*Id.* at 6:25-43.). This technique provides the benefits of bridge and link redundancy without the disadvantages of having multiple IP addresses associated with a single host. (*Id.* at 6:48-62.).

2. The Asserted Claims

Remaining asserted claims 2, 6, 13, and 17 of the '211 patent are recited below.

2. The method of claim 1, further comprising:
tunneling said first LAN with a third LAN through said first intermediate network device, said plurality of LANs comprising said third LAN.
6. The method of claim 2 wherein said aggregating comprises:

Public Version

aggregating a first and a second port of said second intermediate network device, wherein

said first port is coupled to said first intermediate network device over said third LAN, and

said second port is coupled to said host over said second LAN.

13. The computer program product of claim 12, further comprising:

a second set of instructions, executable on said intermediate network device, configured to tunnel a first LAN with a third LAN through said first intermediate network device, said plurality of LANs comprising said third LAN.

17. The computer program product of claim 13, wherein said first set of instructions comprises:

a first sub-set of instructions, executable on said intermediate network device, configured to aggregate a first and a second port of said second intermediate network device, wherein

said first port is coupled to said first intermediate network device over said third LAN, and

said second port is coupled to said host over said second LAN.

(JX-1 at 13:27–15:17.).

H. The Products at Issue.

At issue in this Investigation are certain network devices, related software, and components thereof made and sold by Arista.

Cisco accuses the Arista 7010, 7048, 7050, 7050X, 7150, 7250X, 7280E, 7300, 7300X, and 7500E series switches (“Accused Products”) of infringing the Asserted Patents. (CBr. at 8.).

With respect to domestic industry, Cisco relies on the following products (“DI Products”):

Table of Cisco’s DI Products

Asserted U.S. Patent No.	Cisco Domestic Industry Products
'577 and '853 Patents	Catalyst Switches: 6500 Series Nexus Switches: 3000, 5000, 6000, 7000, 9000 Series

Public Version

Asserted U.S. Patent No.	Cisco Domestic Industry Products
'668 Patent	Catalyst Switches: 6500 Series Cisco Routers: 12000 Series Nexus Switches: 7000 Series
'211 Patent	Catalyst Switches: 6500 Series Nexus Switches: 3000, 5000, 7000 Series
'875 and '492 Patents	Catalyst Switches: 4500, 6500 Series Nexus Switches: 3000, 5000, 6000, 7000 Series

(CBr. at 7 (Table)).

IV. RELEVANT LAW

A. Claim Construction

1. Generally

Claim construction begins with the plain language of the claims themselves. Claims should be given their ordinary and customary meaning as understood by a person of ordinary skill in the art, viewing the claim terms in the context of the entire patent. *Phillips v. AWH Corp.*, 415 F.3d 1303, 1312-13 (Fed. Cir. 2005) *cert. denied*, 546 U.S. 1170 (2006). In some cases, the plain and ordinary meaning of the claims language is readily apparent and claim construction will involve little more than “the application of the widely accepted meaning of commonly understood words.” *Id.* at 1314. In other cases, claim terms have a specialized meaning and it is necessary to determine what a person of ordinary skill in the art would have understood disputed claim language to mean by analyzing “the words of the claims themselves, the remainder of the specification, the prosecution history, and extrinsic evidence concerning relevant scientific principles, as well as the meaning of technical terms, and the state of the art.” *Id.* (quoting *Innova/Pure Water, Inc. v. Safari Water Filtration Sys., Inc.*, 381 F.3d 1111, 1116 (Fed. Cir. 2004)).

Public Version

The claims themselves provide substantial guidance as to the meaning of disputed claim language. *Id.* at 1314. “[T]he context in which a term is used in the asserted claim can be highly instructive.” *Id.* Likewise, other claims of the patent at issue, regardless of whether they have been asserted against respondents, may show the scope and meaning of disputed claim language. *Id.*

With respect to claim preambles, a preamble may limit a claimed invention if it (i) recites essential structure or steps, or (ii) is “necessary to give life, meaning, and vitality” to the claim. *Eaton Corp. v. Rockwell Int'l Corp.*, 323 F.3d 1332, 1339 (Fed. Cir. 2003) (citations omitted). The Federal Circuit has explained that a “claim preamble has the import that the claim as a whole suggests for it. In other words, when the claim drafter chooses to use both the preamble and the body to define the subject matter of the claimed invention, the invention so defined, and not some other, is the one the patent protects.” *Id.* (quoting *Bell Commc’ns Research, Inc. v. Vitalink Commc’ns Corp.*, 55 F.3d 615, 620 (Fed. Cir. 1995)). When used in a patent preamble, the term “comprising” is well understood to mean “including but not limited to,” and thus, the claim is open-ended. *CIAS, Inc. v. Alliance Gaming Corp.*, 504 F.3d 1356, 1360 (Fed. Cir. 2007). The patent term “comprising” permits the inclusion of other unrecited steps, elements, or materials in addition to those elements or components specified in the claims. *Id.*

In cases where the meaning of a disputed claim term in the context of the patent’s claims remains uncertain, the specification is the “single best guide to the meaning of a disputed term.” *Phillips*, 415 F.3d at 1321. Moreover, “[t]he construction that stays true to the claim language and most naturally aligns with the patent’s description of the invention will be, in the end, the correct construction.” *Id.* at 1316. As a general rule, however, the particular examples or embodiments discussed in the specification are not to be read into the claims as limitations. *Id.*

at 1323.

The prosecution history may also explain the meaning of claim language, although “it often lacks the clarity of the specification and thus is less useful for claim construction purposes.” *Id.* at 1317. The prosecution history consists of the complete record of the patent examination proceedings before the U.S. Patent and Trademark Office, including cited prior art. *Id.* It may reveal “how the inventor understood the invention and whether the inventor limited the invention in the course of prosecution, making the claim scope narrower than it would otherwise be.” *Id.*

If the intrinsic evidence is insufficient to establish the clear meaning of a claim, a court may resort²⁷ to an examination of the extrinsic evidence. *Zodiac Pool Care, Inc. v. Hoffinger Industries, Inc.*, 206 F.3d 1408, 1414 (Fed. Cir. 2000). Extrinsic evidence may shed light on the relevant art, and “consists of all evidence external to the patent and prosecution history, including expert and inventor testimony, dictionaries, and learned treatises.” *Phillips*, 415 F.3d at 1317. In evaluating expert testimony, a court should disregard any expert testimony that is conclusory or “clearly at odds with the claim construction mandated by the claims themselves, the written description, and the prosecution history, in other words, with the written record of the patent.” *Id.* at 1318. Furthermore, expert testimony is only of assistance if, with respect to the disputed claim language, it identifies what the accepted meaning in the field would be to one skilled in the art. *Symantec Corp. v. Comput. Assos. Int’l, Inc.*, 522 F.3d 1279, 1289, n.3., 1290-91 (Fed. Cir. 2008). Testimony that recites how each expert would construe the term should be accorded little or no weight. *Id.* Extrinsic evidence is inherently “less reliable” than intrinsic

²⁷ “In those cases where the public record unambiguously describes the scope of the patented invention, reliance on any extrinsic evidence is improper.” *Vitronics Corp. v. Conceptoronic, Inc.*, 90 F.3d 1576, 1583 (Fed. Cir. 1996).

evidence, and “is unlikely to result in a reliable interpretation of patent claim scope unless considered in the context of the intrinsic evidence.” *Phillips*, 415 F.3d at 1318-19.

2. Means-Plus-Function Claims.²⁸

Some patent claim limitations are drafted in means-plus-function format and are governed by 35 U.S.C. § 112 ¶ 6.

An element in a claim for a combination may be expressed as a means or step for performing a specified function without the recital of structure, material, or acts in support thereof, and such claim shall be construed to cover the corresponding structure, material, or acts described in the specification and equivalents thereof.

35 U.S.C. § 112 ¶ 6. According to the Federal Circuit, “[t]he first step in construing a means-plus-function limitation is to identify the function explicitly recited in the claim.” *Asyst Techs., Inc. v. Empak, Inc.*, 268 F.3d 1364, 1369-70 (Fed. Cir. 2001). The function may only include the limitations contained in the claim language: it is improper to narrow or broaden “the scope of the function beyond the claim language.” *Cardiac Pacemakers, Inc. v. St. Jude Med., Inc.*, 296 F.3d 1106, 1113 (Fed. Cir. 2002).

The next step in the analysis of a means-plus-function claim limitation “is to identify the corresponding structure set forth in the written description that performs the particular function set forth in the claim.” *Asyst*, 268 F.3d at 1369-70. Corresponding structure “must not only perform the claimed function, but the specification must clearly associate the structure with performance of the function.” *Cardiac Pacemakers*, 296 F.3d at 1113.

Section 112 paragraph 6 does not ‘permit incorporation of structure from the written description beyond that necessary to perform the claimed function.’ Structural features that do not actually perform the recited function do not constitute corresponding structure and thus do not serve as claim limitations.

²⁸ Claim 46 of the ’853 patent includes means-plus-function limitations. (JX-0003 at 10:47-65; *see also* RBr.II at 7.).

Public Version

Asyst, 268 F.3d at 1369-70 (citations omitted). For example, features that enable the pertinent structure to operate as intended are not the same as corresponding structures that actually perform the stated function. *Id.* at 1371. Different embodiments disclosed in the specification may disclose different corresponding structure. *Cardiac Pacemakers*, 296 F.3d at 1113.

A means-plus-function analysis is “undertaken from the perspective of a person of ordinary skill in the art.” *Id.* While the focal point for determining the corresponding structure is the patent specification, other intrinsic evidence remains relevant. The other claims in a patent “may provide guidance and context for interpreting a disputed means-plus-function limitation, especially if they recite additional functions.” *Wenger Mfg., Inc. v. Coating Mach. Sys., Inc.*, 239 F.3d 1225, 1233-34 (Fed. Cir. 2001). If another claim in the patent recites a separate and distinct function, “the doctrine of claim differentiation indicates that these claims are presumptively different in scope.” *Id.*²⁹ The prosecution history of the patent may also be useful in interpreting a claim written in means-plus-function form. *Cybor Corp. v. FAS Techs., Inc.*, 138 F.3d 1448, 1457 (Fed. Cir. 1998) (abrogated with respect to de novo claim construction).

²⁹ The Federal Circuit has explained that claim differentiation may not be used to circumvent the requirements of Section 112 ¶ 6 but may still play a role during claim construction:

Although the judicially created doctrine of claim differentiation cannot override the statutory requirements of § 112, ¶ 6, it does not necessarily follow that means-plus-function limitations must be interpreted without regard to other claims. Claim differentiation . . . is clearly applicable when there is a dispute over whether a limitation found in a dependent claim should be read into an independent claim, and that limitation is the only meaningful difference between the two claims.

* * *

We explained that “[a] means-plus-function limitation is not made open-ended by the presence of another claim specifically claiming the disclosed structure which underlies the means clause or an equivalent of that structure.” Thus, *Laitram* held that the stringencies of a means-plus-function limitation are not to be avoided by the mere addition of a dependent claim that recites the corresponding structure disclosed in the specification. However, *Laitram* does not stand for the broader proposition suggested by CMS, viz., that a means-plus-function limitation must be interpreted without regard to other claims.

Id. (internal citations omitted).

“[P]ositions taken before the PTO³⁰ may bar an inconsistent position on claim construction under § 112 ¶6” if a “competitor would reasonably believe that the applicant had surrendered the relevant subject matter” as a result of “clear assertions made in support of patentability.” *Id.*

B. Infringement³¹

1. Direct Infringement

“Determination of infringement is a two-step process which consists of determining the scope of the asserted claim (claim construction) and then comparing the accused product . . . to the claim as construed.” *Certain Sucralose, Sweeteners Containing Sucralose, and Related Intermediate Compounds Thereof*, Inv. No. 337-TA-604, Comm’n Op. at 36 (U.S.I.T.C., April 28, 2009) (citing *Litton Sys., Inc. v. Honeywell, Inc.*, 140 F.3d 1449, 1454 (Fed. Cir. 1998) “*Litton*”).

An accused device literally infringes a patent claim if it contains each limitation recited in the claim exactly. *Litton*, 140 F.3d at 1454. Each patent claim element or limitation is considered material and essential. *London v. Carson Pirie Scott & Co.*, 946 F.2d 1534, 1538 (Fed. Cir. 1991). In a Section 337 investigation, the complainant bears the burden of proving infringement of the asserted patent claims by a preponderance of the evidence. *Enercon GmbH v. Int’l Trade Comm’n*, 151 F.3d 1376, 1384 (Fed. Cir. 1998). If any claim limitation is absent, there is no literal infringement of that claim as a matter of law. *Bayer AG v. Elan Pharm. Research Corp.*, 212 F.3d 1241, 1247 (Fed. Cir. 2000).

Where literal infringement is not found, infringement can still be found under the doctrine of equivalents. The Supreme Court has described the essential inquiry of the doctrine of

³⁰ “PTO” is an acronym for the “U.S. Patent and Trademark Office.”

³¹ Cisco asserts infringement of all of the Asserted Patents. (Compl. at ¶¶ 12-26.).

Public Version

equivalents analysis in terms of whether the accused product or process contains elements identical or equivalent to each claimed element of the patented invention. *Warner-Jenkinson Co., Inc. v. Hilton Davis Chemical Co.*, 520 U.S. 17, 40 (1997). According to the Federal Circuit:

Infringement under the doctrine of equivalents may be found when the accused device contains an “insubstantial” change from the claimed invention. Whether equivalency exists may be determined based on the “insubstantial differences” test or based on the “triple identity” test, namely, whether the element of the accused device “performs substantially the same function in substantially the same way to obtain the same result.” The essential inquiry is whether “the accused products or process contain elements identical or equivalent to each claimed element of the patented invention[.]”

TIP Sys., LLC v. Phillips & Brooks/Gladwin, Inc., 529 F.3d 1364, 1376-77 (Fed. Cir. 2008) (citations omitted).

2. Induced Infringement³²

“Whoever actively induces infringement of a patent shall be liable as an infringer.” 35 U.S.C. § 271(b). A patentee asserting a claim of inducement must show (i) that there has been direct infringement³³ and (ii) that the alleged infringer “knowingly induced infringement and possessed specific intent to encourage another’s infringement.” *Minnesota Mining & Mfg. Co. v. Chemque, Inc.*, 303 F.3d 1294, 1304-05 (Fed. Cir. 2002). With respect to the direct infringement requirement, the patentee “must either point to specific instances of direct infringement or show that the accused device necessarily infringes the patent in suit.” *ACCO Brands, Inc. v. ABA Locks Mfrs. Co., Ltd.*, 501 F.3d 1307, 1313 (Fed. Cir. 2007) (citation omitted). This requirement may be shown by circumstantial evidence. *Vita-Mix Corp. v. Basic Holding, Inc.*, 581 F.3d

³² Cisco asserts that Arista indirectly infringes all of the Asserted Patents. (Compl. at ¶¶ 41, 46, 51, 56, 61, 66.).

³³ See also *Limelight Networks, Inc. v. Akamai Technologies, Inc.*, 134 S.Ct. 2111, 2117 (2014).

1317, 1326 (Fed. Cir. 2009). “[A] finding of infringement can rest on as little as one instance of the claimed method being performed during the pertinent time period.” *Lucent Techs., Inc. v. Gateway, Inc.*, 580 F.3d 1301, 1317 (Fed. Cir. 2009).

The specific intent requirement for inducement necessitates a showing that the alleged infringer was aware of the patent, induced direct infringement, and that he knew that his actions would induce actual direct infringement. *Commil USA, LLC v. Cisco Systems, Inc.*, 720 F.3d 1361, 1367 (Fed. Cir. 2013), *aff’d and vacated in part on other grounds*, 135 S.Ct. 1920, 1926-28 (2015); *Global-Tech Appliances, Inc. v. SEB S.A.*, 131 S.Ct. 2060, 2068-70 (2011) (holding that willful blindness may be sufficient to meet specific intent requirement). Willful blindness, which will also constitute such “knowledge,” has two basic requirements: “(1) the defendant must subjectively believe that there is a high probability that a fact exists”; and “(2) the defendant must take deliberate actions to avoid learning of that fact.” *Global-Tech*, 131 S.Ct. at 2070. The intent to induce infringement may be proven with circumstantial or direct evidence and may be inferred from all the circumstances. *Commil*, 720 F.3d at 1366; *Global-Tech*, 131 S.Ct. 2071-72.

The Federal Circuit has upheld the Commission’s authority to cover “goods that were used by an importer to directly infringe post-importation as a result of the seller’s inducement.” *Suprema Inc. v. Int’l Trade Comm’n*, 796 F.3d 1338, 1352-53 (Fed. Cir. 2015).

3. Contributory Infringement³⁴

35 U.S.C. § 271(c) sets forth the rules for contributory infringement:

Whoever offers to sell or sells within the United States or imports into the United States a component of a patented machine, manufacture, combination, or

³⁴ Cisco asserts that Arista contributorily infringes the Asserted Patents. (Compl. at ¶¶ 42, 47, 52, 57, 62, 67.).

Public Version

composition, or a material or apparatus for use in practicing a patented process, constituting a material part of the invention, knowing the same to be especially made or especially adapted for use in an infringement of such patent, and not a staple article or commodity of commerce suitable for substantial noninfringing use, shall be liable as a contributory infringer.

35 U.S.C. § 271(c). Specifically with respect to Section 337 investigations, the Federal Circuit has held that “to prevail on contributory infringement in a Section 337 case, the complainant must show inter alia: (1) there is an act of direct infringement in violation of Section 337; (2) the accused device has no substantial non-infringing uses; and (3) the accused infringer imported, sold for importation, or sold after importation within the United States, the accused components that contributed to another’s direct infringement.” *Spansion, Inc. v. International Trade Comm’n*, 629 F.3d 1331, 1353 (Fed. Cir. 2010). “[N]on-infringing uses are substantial when they are not unusual, far-fetched, illusory, impractical, occasional, aberrant, or experimental.” *Vita-Mix*, 581 F.3d at 1327. To determine whether a use is substantial, an Administrative Law Judge may evaluate “the use’s frequency, . . . the use’s practicality, the invention’s intended purpose, and the intended market.” *i4i Ltd. Partnership v. Microsoft Corp.*, 598 F.3d 831, 851 (Fed. Cir. 2010). Section 271(c) also requires knowledge of the existence of the patent that is infringed. *Global-Tech*, 131 S.Ct. at 2068.

To satisfy contributory infringement’s knowledge requirement, it is necessary to establish that “the accused contributory infringer knows that its component is included in a combination that is patented and infringing.” This requires knowledge of the patent. *Global-Tech Appliances*, 131 S.Ct. at 2068. In addition, the Federal Circuit has held that it is not sufficient to know of the patent and the relevant acts, but must also know that “these acts constituted infringement.” *Fujitsu Ltd. v. LG Elecs.*, 620 F.3d 1321, 1320 (Fed. Cir. 2010). For purposes of contributory infringement, such knowledge is inferred where the article at issue has no

substantial non-infringing uses. *See Certain Semiconductor Chips with Minimized Chip Package Size and Prods. Containing Same*, Inv. No. 337-TA-605, 2009 WL 8144934, at *28, Comm'n Determination (June 3, 2009).

Where infringement allegations address a “separate and distinct” feature of a product, the contributory infringement analysis (for example, with respect to the existence of non-infringing uses) may address the particular feature in question rather than the product as a whole. *See i4i Partnership v. Microsoft Corp.*, 598 F.3d 831, 849 (Fed. Cir. 2010); *Lucent Techs., Inc. v. Gateway, Inc.*, 580 F.3d 1301, 1320-21 (Fed. Cir. 2009); *Ricoh Co. Ltd. v. Quanta Comput. Inc.*, 550 F.3d 1325, 1338 (Fed. Cir. 2008).

C. Validity³⁵

One cannot be held liable for practicing an invalid patent claim. *See Pandrol USA, LP v. AirBoss Railway Prods., Inc.*, 320 F.3d 1354, 1365 (Fed. Cir. 2003). However, patent claims are presumed valid. 35 U.S.C. § 282. A respondent that has raised patent invalidity as an affirmative defense must overcome the presumption by “clear and convincing” evidence of invalidity. *Checkpoint Systems, Inc. v. United States Int'l Trade Comm'n*, 54 F.3d 756, 761 (Fed. Cir. 1995). Further, as stated by the Federal Circuit in *Ultra-Tex Surfaces, Inc. v. Hill Bros. Chem. Co.*:

when a party alleges that a claim is invalid based on *the very same references* that were before the examiner when the claim was allowed, that party assumes the following additional burden:

When no prior art other than that which was considered by the PTO examiner is relied on by the attacker, he has the added burden³⁶ of overcoming the deference

³⁵ Arista asserts that the Asserted Patents are invalid. (Resp. at ¶¶ 30-35.).

³⁶ This is not an added burden of proof but instead goes to the weight of the evidence. *Sciele Pharma v. Lupin Ltd.*, 684 F.3d 1253, 1260-61 (Fed. Cir. 2012). New evidence not considered by the PTO may carry more weight than

that is due to a qualified government agency presumed to have properly done its job, which includes one or more examiners who are assumed to have some expertise in interpreting the references and to be familiar from their work with the level of skill in the art and whose duty it is to issue only valid patents.

Ultra-Tex Surfaces, Inc. v. Hill Bros. Chem. Co., 204 F.3d 1360, 1367 (Fed. Cir. 2000)

(emphasis added) (quoting *American Hoist & Derrick Co. v. Sowa & Sons, Inc.*, 725 F.2d 1350, 1359 (Fed. Cir. 1984) (“*American Hoist*”).

1. Anticipation³⁷

A determination that a patent is invalid as being anticipated under 35 U.S.C. § 102 requires a finding, based upon clear and convincing evidence, that each and every limitation is found either expressly or inherently in a single prior art reference. See *Celeritas Techs. Inc. v. Rockwell Int’l Corp.*, 150 F.3d 1354, 1361 (Fed. Cir. 1998). Anticipation is a question of fact, including whether a limitation, or element, is inherent in the prior art. *In re Gleave*, 560 F.3d 1331, 1334-35 (Fed. Cir. 2009). The limitations must be arranged or combined the same way as in the claimed invention, although an identity of terminology is not required. *Id.* at 1334 (“the reference need not satisfy an *ipsissimis verbis* test”); MPEP § 2131.

In addition, the prior art reference’s disclosure must enable one of ordinary skill in the art to practice the claimed invention “without undue experimentation.” *Gleave*, 560 F.3d at 1334-35. A prior art reference that allegedly anticipates the claims of a patent is presumed enabled; however, a patentee may present evidence of nonenablement to overcome this presumption. *Impax Labs., Inc. v. Aventis Pharmaceuticals Inc.*, 468 F.3d 1366, 1382 (Fed. Cir. 2006).

evidence previously considered by the PTO. (*Id.*)

³⁷ Arista asserts that the Asserted Patents are anticipated by the prior art. (Resp. at ¶¶ 7-12.).

Public Version

“[W]hether a prior art reference is enabling is a question of law based upon underlying factual findings.” *Gleave*, 560 F.3d at 1335.

2. Obviousness³⁸

Under 35 U.S.C. § 103(a), a patent is valid unless “the differences between the subject matter sought to be patented and the prior art are such that the subject matter as a whole would have been obvious at the time the invention was made” to a person having ordinary skill in the art. 35 U.S.C. § 103(a). The ultimate question of obviousness is a question of law, but “it is well understood that there are factual issues underlying the ultimate obviousness decision.” *Richardson-Vicks*, 122 F.3d at 1479 (citing *Graham v. John Deere Co. of Kansas City*, 383 U.S. 1, 17 (1966) (“*Graham*”).

After claim construction, “[t]he second step in an obviousness inquiry is to determine whether the claimed invention would have been obvious as a legal matter, based on underlying factual inquiries including: (1) the scope and content of the prior art, (2) the level of ordinary skill in the art, (3) the differences between the claimed invention and the prior art; and (4) secondary considerations of non-obviousness.” *Smiths Indus. Med. Sys., Inc. v. Vital Signs, Inc.*, 183 F.3d 1347, 1354 (Fed. Cir. 1999) (citing *Graham*, 383 U.S. at 17). The existence of secondary considerations of non-obviousness does not control the obviousness determination: a court must consider “the totality of the evidence” before reaching a decision on obviousness. *Richardson-Vicks*, 122 F.3d at 1483.

The Supreme Court clarified the obviousness inquiry in *KSR Int’l Co. v. Teleflex Inc.*, 550 U.S. 389 (2007) (“*KSR*”). The Supreme Court said:

³⁸ Arista asserts that the Asserted Patents are obvious in view of the prior art. (Resp. at ¶¶ 7-12.).

Public Version

When a work is available in one field of endeavor, design incentives and other market forces can prompt variations of it, either in the same field or a different one. If a person of ordinary skill can implement a predictable variation, § 103 likely bars its patentability. For the same reason, if a technique has been used to improve one device, and a person of ordinary skill in the art would recognize that it would improve similar devices in the same way, using the technique is obvious unless its actual application is beyond his or her skill. *Sakraida* and *Anderson's-Black Rock* are illustrative—a court must ask whether the improvement is more than the predictable use of prior art elements according to their established functions.

Following these principles may be more difficult in other cases than it is here because the claimed subject matter may involve more than the simple substitution of one known element for another or the mere application of a known technique to a piece of prior art ready for the improvement. Often, it will be necessary for a court to look to interrelated teachings of multiple patents; the effects of demands known to the design community or present in the marketplace; and the background knowledge possessed by a person having ordinary skill in the art, all in order to determine whether there was an apparent reason to combine the known elements in the fashion claimed by the patent at issue. To facilitate review, this analysis should be made explicit.

* * *

The obviousness analysis cannot be confined by a formalistic conception of the words teaching, suggestion, and motivation, or by overemphasis on the importance of published articles and the explicit content of issued patents. The diversity of inventive pursuits and of modern technology counsels against limiting the analysis in this way. In many fields it may be that there is little discussion of obvious techniques or combinations, and it often may be the case that market demand, rather than scientific literature, will drive design trends. Granting patent protection to advances that would occur in the ordinary course without real innovation retards progress and may, in the case of patents combining previously known elements, deprive prior inventions of their value or utility.

KSR, 550 U.S. at 417-19.

The Federal Circuit has since held that when a patent challenger contends that a patent is invalid for obviousness based on a combination of several prior art references, “the burden falls on the patent challenger to show by clear and convincing evidence that a person of ordinary skill in the art would have had reason to attempt to make the composition or device, or carry out the claimed process, and would have had a reasonable expectation of success in doing so.”

PharmaStem Therapeutics, Inc. v. ViaCell, Inc., 491 F.3d 1342, 1360 (Fed. Cir. 2007) (citations omitted).

The TSM³⁹ test, flexibly applied, merely assures that the obviousness test proceeds on the basis of evidence--teachings, suggestions (a tellingly broad term), or motivations (an equally broad term)--that arise before the time of invention as the statute requires. As *KSR* requires, those teachings, suggestions, or motivations need not always be written references but may be found within the knowledge and creativity of ordinarily skilled artisans.

Ortho-McNeil Pharm., Inc. v. Mylan Labs., Inc., 520 F.3d 1358, 1365 (Fed. Cir. 2008).

3. Indefiniteness⁴⁰

A patent specification must “conclude with one or more claims particularly pointing out and distinctly claiming the subject matter which the applicant regards as [the] invention.”

35 U.S.C. § 112, ¶ 2. Previously, the Federal Circuit held that a patent claim is not indefinite “so long as the claim is amenable to construction, and the claim, as construed, is not insolubly ambiguous.” *Nautilus, Inc. v. Biosig Instruments, Inc.*, 134 S.Ct. 2120, 2124 (2014). More recently, the U.S. Supreme Court determined that this standard lacks precision. *Id.* at 2130.

Instead, the Supreme Court held:

we read § 112, ¶ 2 to require that a patent's claims, viewed in light of the specification and prosecution history, inform those skilled in the art about the scope of the invention with reasonable certainty. The definiteness requirement, so understood, mandates clarity, while recognizing that absolute precision is unattainable. The standard we adopt accords with opinions of this Court stating that “the certainty which the law requires in patents is not greater than is reasonable, having regard to their subject-matter.”

Id. at 2129 (citations omitted). A party seeking to invalidate a patent claim must do so by clear and convincing evidence. *See, e.g., Tech. Licensing Corp. v. Videotek, Inc.*, 545 F.3d 1316, 1327

³⁹ TSM is an acronym that stands for teaching, suggestion, motivation.

⁴⁰ Arista asserts that the '577 and '853 patents are indefinite. (Resp. at ¶ 13; RBr.II at 36.).

(Fed. Cir. 2008) (citing *Hybritech Inc. v. Monoclonal Antibodies, Inc.*, 802 F.2d 1367, 1375 (Fed. Cir. 1986)).

4. Written Description⁴¹

Patents are presumed valid. 35 U.S.C. § 282. The first paragraph of Section 112 says: “The specification shall contain a written description of the invention, and of the manner and process of making and using it, in such full, clear, concise, and exact terms as to enable any person skilled in the art to which it pertains, or with which it is most nearly connected, to make and use the same. . . .” 35 U.S.C. § 112. To comply, a patent applicant must “convey with reasonable clarity to those skilled in the art that, as of the filing date sought, he or she was in possession of the [claimed] invention.” *Vas-Cath Inc. v. Mahurkar*, 935 F.2d 1555, 1563-64 (Fed. Cir. 1991) (emphasis omitted). “The form and presentation of the description can vary with the nature of the invention[.]” *In re Skvorecz*, 580 F.3d 1262, 1269 (Fed. Cir. 2009). “[T]he applicant [for a patent] may employ ‘such descriptive means as words, structures, figures, diagrams, formulas, etc., that fully set forth the claimed invention.’” *Id.* (citing *In re Alton*, 76 F.3d 1168, 1172 (Fed. Cir. 1996)). The adequacy of the description depends on content, rather than length. *In re Hayes Microcomputer Prods., Inc. Patent Litig.*, 982 F.2d 1527, 1534 (Fed. Cir. 1992). “Specifically, the level of detail required to satisfy the written description requirement varies depending on the nature and scope of the claims and on the complexity and predictability of the relevant technology.” *Ariad Pharms., Inc. v. Eli Lilly & Co.*, 598 F.3d 1336, 1352 (Fed. Cir. 2010) (en banc).

Compliance with the written description requirement is a question of fact, and in order to

⁴¹ Arista asserts that the ’577 and ’853 patents lack written description. (Resp. at ¶ 13; RBr.II at 37.).

Public Version

overcome the presumption of validity a party must set forth clear and convincing evidence. *Centocor Ortho Biotech, Inc. v. Abbott Labs.*, 636 F.3d 1341, 1347 (Fed. Cir. 2011). The Federal Circuit has also held with respect to the written description requirement that “[a] claim will not be invalidated on section 112 grounds simply because the embodiments of the specification do not contain examples explicitly covering the full scope of the claim language.” *Falko-Gunter Falkner v. Inglis*, 448 F.3d 1357, 1366 (Fed. Cir. 2006) (quoting *LizardTech, Inc. v. Earth Resource Mapping, PTY, Inc.*, 424 F.3d 1336, 1345 (Fed. Cir. 2005)).

5. Patent Eligibility⁴²

Section 101 of the Patent Act states: “Whoever invents or discovers any new and useful process, machine, manufacture, or composition of matter, or any new and useful improvement thereof, may obtain a patent therefor, subject to the conditions and requirements of this title.” 35 U.S.C. § 101. In *Alice Corp. Pty. Ltd. v. CLS Bank Int’l*, 134 S. Ct. 2347 (2014), the Supreme Court explained that, the application of section 101 requires courts to “distinguish between patents that claim the ‘buildin[g] block[s]’ of human ingenuity and those that integrate the building blocks into something more.” *Id.* at 2354 (quoting *Mayo Collaborative Servs. v. Prometheus Labs., Inc.*, 132 S.Ct. 1289, 1294 (2012)). To make this distinction, courts must first “determine whether the claims at issue are directed to a patent-ineligible concepts,” such as the “laws of nature, natural phenomena, and abstract ideas.” *Id.* at 2355 (citing *Mayo*, 132 S.Ct. at 1296-1297)). If so, courts must examine the elements of the claim to determine whether it contains an ‘inventive concept’ sufficient to ‘transform’ the claimed abstract idea into a patent-eligible application.” *Id.*

⁴² Arista asserts that the ’875 and ’492 patents are patent-ineligible. (Answer ¶ 5; RBr.II at 115-16.).

Public Version

“[T]he prohibition against patenting abstract ideas cannot be circumvented by attempting to limit the use of the idea to a particular technological environment.” *Id.* at 2358 (quoting *Bilski v. Kappos*, 561 U.S. 593, 610-611 (2010)). In other words, “transformation into a patent-eligible application requires ‘more than simply stat[ing] the [abstract idea] while adding the words ‘apply it.’” *Id.* at 2357 (alteration in original) (citing *Mayo*, 132 S.Ct. at 1294).

However, “[a]t some level, ‘all inventions . . . embody, use, reflect, rest upon, or apply laws of nature, natural phenomena, or abstract ideas.’ Thus, an invention is not rendered ineligible for patent simply because it involves an abstract concept.” *Id.* at 2354 (quoting *Mayo*, 132 S.Ct. at 1293-94; citing *Diamond v. Diehr*, 450 U.S. 175, 187 (1981)). “[A]pplication[s]’ of such concepts ‘to a new and useful end’ . . . remain eligible for patent protection.” *Id.* (quoting *Gottschalk v. Benson*, 409 U.S. 63, 67 (1972)).

D. Assignor Estoppel⁴³

“Assignor estoppel is an equitable doctrine that prevents one who has assigned the rights to a patent . . . from later contending that what was assigned is a nullity.” *Diamond Sci. Co. v. Ambico, Inc.*, 848 F.2d 1220, 1224 (Fed. Cir. 1988). One who assigns patent rights is presumed to have made an “implicit representation” that the rights assigned “are not worthless.” *Mentor Graphics Corp. v. Quickturn Design Sys., Inc.*, 150 F.3d 1374, 1377 (Fed. Cir. 1998) (quoting *Diamond*, 848 F.2d at 1224). Thus, an assignor is estopped from raising defenses asserting, in effect, “what [it] has sold as a patent was not a patent.” *Diamond*, 848 F.2d at 1224. “The estoppel historically has applied to invalidity challenges based on ‘novelty, utility, patentable invention, anticipatory matter, and the state of the art.’” *Id.* (quoting *Babcock v. Clarkson*, 63 F.

⁴³ Cisco asserts that Arista is estopped from challenging the validity of the ’577 and ’853 patents under the equitable doctrine of assignor estoppel. (CPBr. at 50-51; CBr.II at 38-40.).

Public Version

607, 609 (1st Cir. 1984)). The bar can also extend to the inequitable conduct equitable defense.

See Shamrock Techs., Inc. v. Med. Sterilization, Inc., 903 F.2d 789, 794 (Fed. Cir. 1990).

Assignor estoppel applies to assignors, and to “other parties in privity with the assignor such as a corporation founded by the assignor.” *Diamond*, 848 F.2d at 1224. Privity depends on a balancing of equities based on the strength of the relationship between the assignor and the other party. *Shamrock*, 903 F.2d at 793. Privity does not require that the assignor designed or worked on the infringing technology. *Mentor Graphics*, 150 F.3d at 1379 (finding privity between two companies, even though the assignor company did not develop the accused product). If facts such as these are present, they favor a finding of privity, but they are not required.

“What is significant is whether the ultimate infringer availed itself of the inventor’s ‘knowledge and assistance.’” *Intel Corp. v. U.S. Int’l Trade Comm’n*, 947 F.2d 821, 839 (Fed. Cir. 1991). The following factors considered in *Shamrock* are useful in making this determination:

- (1) “the assignor’s leadership role at the new employer;
- (2) the assignor’s ownership stake in the defendant company;
- (3) whether the defendant company changed course from manufacturing noninfringing goods to infringing activity after the inventor was hired;
- (4) the assignor’s role in the infringing activities;
- (5) whether the inventor was hired to start the infringing operations;
- (6) whether the decision to manufacture the infringing product was made partly by the inventor;
- (7) whether the defendant company began manufacturing the accused product shortly after hiring the assignor; and
- (8) whether the inventor was in charge of the infringing operation.”

Public Version

MAG Aerospace Indus., Inc. v. B/E Aerospace, Inc., 816 F.3d 1374, 1380 (Fed. Cir. 2016) (citing *Shamrock Techs., Inc. v. Med. Sterilization, Inc.*, 903 F.2d 793 (Fed. Cir. 1990); *Certain Integrated Circuits, Processes for Making Same, and Prods. Containing Same*, Inv. No. 337-TA-450, Initial Determination, 2002 WL 31662205, at *23 (May 6, 2002), *rescinded in part on other grounds*, Commission Notice of Final Determination, 2002 WL 32167046 (Oct. 7, 2002).

E. Equitable Defenses

1. Equitable Estoppel⁴⁴

To establish the affirmative defense of estoppel, an alleged infringer must demonstrate: “(1) misleading conduct, which may include not only statements and action but silence and inaction, leading another to reasonably infer that rights will not be asserted against it; (2) reliance upon this conduct; and (3) due to this reliance, material prejudice if the delayed assertion of such rights is permitted.” *Certain Bearings and Packaging Thereof*, Inv. No. 337-TA-487, Initial Determination at 28 (April 10, 2003) (internal citations omitted). Notably, “[r]eliance is not the same as prejudice or harm, although frequently confused . . . [t]o show reliance, the infringer must have had a relationship or communication with the plaintiff which lulls the infringer into a sense of security.” *Id.* (quoting *A.C. Aukerman Co. v. R. L. Chaides Constr. Co.*, 960 F.2d 1020, 1033 (Fed. Cir. 1992) (en banc)). Material prejudice may be established by a showing of “change of economic position or loss of evidence.” *Aukerman*, 960 F.2d at 1033. Additionally, egregious conduct on the part of the alleged infringer must also be considered. *Bearings*, Initial Determination at 28.

It is well-established that all relief, including prospective relief, may be barred by

⁴⁴ Arista claims that the equitable defense of equitable estoppel bars Cisco from relief with regard to the '668, '211, '875, '492, '577, and '853 patents. (Resp. at pp.36-38, ¶¶ 16-22; *see also* RBr. at 61-64, 97, 117-18; RBr.II at 41.). Arista's defense has been rejected. (*See infra* at Section IX.A.).

equitable estoppel. *Aukerman*, 960 F.2d at 1041. Nevertheless, application of the doctrine is given to the sound discretion of the trial judge. *Id.* at 1028.

2. Waiver⁴⁵

“[W]aiver is the ‘intentional relinquishment or abandonment of a known right.’” *United States v. Olano*, 507 U.S. 725, 733 (1993) (quoting *Johnson v. Zerbst*, 304 U.S. 458, 464 (1938)). “To support a finding of implied waiver in the standard setting organization context, the accused must show by clear and convincing evidence that ‘[the patentee’s] conduct was so inconsistent with an intent to enforce its rights as to induce a reasonable belief that such right has been relinquished.’” *Hynix Semiconductor Inc. v. Rambus, Inc.*, 645 F.3d 1336, 1348 (Fed. Cir. 2011) (citing *Qualcomm Inc. v. Broadcom Corp.*, 548 F.3d 1004, 1020 (Fed. Cir. 2008)).

3. Implied License⁴⁶

An implied license may arise “where the circumstances plainly indicate that the grant of a license should be inferred.” *Bandag, Inc. v. Al Bolser’s Tire Stores, Inc.*, 750 F.2d 903, 925 (Fed. Cir. 1984) (citing *Hunt v. Armour & Co.*, 185 F.2d 722, 729 (7th Cir. 1950)). An implied license “signifies a patentee’s waiver of the statutory right to exclude others from making, using, selling, offering to sell, or importing the patented invention,” and may be established by: (1) equitable estoppel; (2) acquiescence; (3) conduct; or (4) legal estoppel. *Wang Labs., Inc. v. Mitsubishi Elecs. Am., Inc.*, 103 F.3d 1571, 1580-81 (Fed. Cir. 1997).

⁴⁵ Arista claims that the equitable defenses of implied license and waiver bar Cisco from relief with regard to the ’668 patent. (Resp. at pp.36-38, ¶¶ 16-22; *see also* RBr. at 64-65.). Arista’s defense has been rejected. (*See infra* at Section IX.B.).

⁴⁶ *See supra* note 26.

4. Laches⁴⁷

Section 337(c) provides that “[a]ll legal and equitable defenses may be presented in all cases.” 19 U.S.C. § 1337(c). Pursuant to this provision, legal and equitable defenses to infringement cognizable in federal district courts may generally be asserted before the Commission. *See Lannom Mfg. Co. v. US. Int’l Trade Comm’n*, 799 F.2d 1572, 1576-79 (Fed. Cir. 1986).

In *Aukerman v. Chaides*, the Federal Circuit held that the equitable defense of laches applied only to past damages, and can not bar prospective relief. *See Aukerman*, 960 F.2d 1020, 1041 (Fed. Cir. 1992) (en banc) (“[L]aches bars relief on patentee’s claim only with respect to damages accrued prior to suit.”). Under this authority, the Commission had previously determined that laches is not available as a defense before the Commission. *See Certain Personal Watercraft and Components Thereof*, Inv. No. 337-TA-452, Initial Determination, Order No. 54 at 2 (Sept. 19, 2001) (EDIS Doc. ID No. 61574) (unreviewed, EDIS Doc. ID No. 61619); *Certain EPROM, EEPROM, Flash Memory, and Flash Memory Microcontroller Semiconductor Devices*, Inv. 337-TA-395, Supplemental Views of Commission Bragg at n.65, 1998 WL 35428257, at *28 (Oct. 1998) (“The facts of this case suggest an attempt . . . to take what is essentially a laches defense and bootstrap it into prospective relief, which *Aukerman* holds to be impossible.”).

The Federal Circuit recently issued an en banc decision rejecting *Aukerman’s* “bright line Rule” regarding laches and prospective relief. *See SCA Hygiene Prods. Aktiebolag SCA Personal Care, Inc. v. First Quality Baby Prods., LLC*, 807 F.3d 1311 (Fed. Cir. 2015) (en banc).

⁴⁷ Arista claims that the equitable defense of laches bars Cisco from relief with regard to the ’668, ’211, ’875, ’492, ’577, and ’853 patents. (Resp. at pp.36-38, ¶¶ 16-22; *see also* RBr. at 66-69, 98, 118-19; RBr.II at 42.). Arista’s defense has been rejected. (*See infra* at Section IX.C.).

Public Version

The *SCA Hygiene* opinion explained that the court convened en banc to resolve whether, “in light of the Supreme Court’s recent decision in *Petrella v. Metro-Goldwyn-Mayer, Inc.*, 134 S. Ct. 1962 (2014), laches remains a defense to legal relief in a patent infringement suit.” *SCA Hygiene*, 807 F.3d at 1315. Although *Petrella* concerned a copyright infringement cause of action and one of the issues concerned a delay in the assertion of that cause of action, the *SCA Hygiene* court stated that “[s]till, *Petrella* clearly casts doubt on several aspects of *Aukerman*.” *Id.* at 1321. Ultimately, the *SCA Hygiene* court held that laches considerations can be applied in assessing prospective relief, including with respect to injunctions and, in “extraordinary circumstances,” to ongoing royalties. *See id.* at 1315 (“We emphasize that equitable principles apply whenever an accused infringer seeks to use laches to bar ongoing relief.”).

In order to prevail in a laches defense in the event that such a defense is appropriate under the circumstances of this investigation, Arista must prove that: (1) Cisco delayed in bringing an infringement lawsuit for an “unreasonable and inexcusable” length of time from when it knew or reasonably should have known of its infringement claim against the accused infringer; and (2) the delay caused “material prejudice” or injury (economic or evidentiary) to the defendant. *See Aukerman*, 960 F.2d at 1028. A presumption of laches may apply only where the delay in bringing suit is more than 6 years. *Id.* at 1035. This period begins with a patentee’s actual or constructive knowledge of defendant’s infringement and counts forward. *Id.* at 1035-36.

5. Unclean Hands⁴⁸

A complainant who seeks justice must come into court with clean hands or “the doors of the court will be shut.” *Aptix Corp. v. Quickturn Design Sys., Inc.*, 269 F.3d 1369, 1375 (Fed. Cir. 2001) (quoting *Keystone Driller Co. v. Gen. Excavator Co.*, 54 S.Ct. 146, 147 (1933)). To prove unclean hands, Arista must prove that Cisco “conducted [itself] as to shock the moral sensibilities of the judge.” *Gaudiosi v. Mellon*, 269 F.2d 873, 882 (3d Cir. 1959).

6. Patent Misuse⁴⁹

“Patent misuse is an equitable defense to patent infringement.” *U.S. Philips Corp. v. Int’l Trade Comm’n*, 424 F.3d 1179, 1184 (Fed. Cir. 2005). A finding of misuse renders a patent temporarily unenforceable until the misuse has been purged. *Qualcomm Inc. v. Broadcom Corp.*, 548 F.3d 1004, 1025 (Fed. Cir. 2008) (quoting *B. Braun Medical, Inc. v. Abbott Labs.*, 124 F.3d 1419, 1427 (Fed. Cir. 1997)). “The doctrine of patent misuse is [] grounded in the policy-based desire to ‘prevent a patentee from using the patent to obtain market benefit beyond that which inheres in the statutory patent right.’” *Princo Corp. v. Int’l Trade Comm’n*, 616 F.3d 1318, 1328 (Fed. Cir. 2010) (en banc) (quoting *Mallinckrodt, Inc. v. Medipart, Inc.*, 976 F.2d 700, 704 (Fed. Cir. 1992)). Thus, “the key inquiry under the patent misuse doctrine is whether, by imposing the condition in question, the patentee has impermissibly broadened the physical or temporal scope of the patent grant and has done so with anticompetitive effects.” *Id.* (citing *B. Braun Medical*, 124 F.3d at 1426); *see also Monsanto Co. v. McFarling*, 363 F.3d 1336, 1341 (Fed. Cir. 2004)

⁴⁸ Arista claims that the equitable defense of unclean hands bars Cisco from relief with regard to the ’668, ’211, ’875, ’492, ’577, and ’853 patents. (Resp. at pp.36-38, ¶¶ 16-22; *see also* RBr. at 65-66, 97-98, 118; RBr.II at 41-42.). Arista’s defense was rejected. (*See infra* at Section IX.D.).

⁴⁹ In its Response, Arista raised the equitable defense of patent misuse against the asserted claims. (Resp. at pp.36-38, ¶¶ 16-22.). In its Pre-Hearing Brief, Arista claims that patent misuse bars Cisco from relief with regard to the 668 patent. (RPBr. At 122, 126-27.). Arista’s defense was rejected. (*See infra* at Section IX.E.).

(quoting *C.R. Bard, Inc. v. M3 Sys., Inc.*, 157 F.3d 1340, 1372 (Fed. Cir. 1998)).

V. The '577 and '853 Patents

A. Level of Ordinary Skill in the Art

A person of ordinary skill in the art for the '577 and '853 patents has been defined as a person who holds at least a Bachelor of Science degree in electrical engineering, computer engineering, or computer science, or an equivalent degree, and has approximately two years of related experience in the field of network devices. (*Markman* Order at 12.). Additional formal education in a relevant field, such as work toward a master's or doctoral degree in computer science, computer engineering, electrical engineering, or an equivalent field, would have reduced the amount of industry experience one of skill would have needed in the art. (*Id.*).

B. Disputed Terms

1. '577 Patent, Claims 1-9; '853 Patent, Claim 46—“access control patterns”⁵⁰

Cisco's Proposed Construction	Arista's Proposed Construction	Staff's Proposed Construction
patterns of bits or other elements used for access control	These terms are indefinite/not amenable to construction under 35 U.S.C. § 112 ¶ 2 at least because “access control patterns” are not described in the specification.	patterns of bits or other elements used for access control and stored in an associative memory

As contained in the claims themselves, an access control pattern can include a bit pattern for matching and a mask pattern of bits not for matching. (JX-5 claim 3.). An access control

⁵⁰ See Joint Report Regarding the Parties' Efforts to Further Reduce the Number of Disputed Claim Terms at Attach. A, p. 1 (“Joint Claim Construction Report”) (Doc. ID. No. 568754 (Nov. 10, 2015)).

Public Version

pattern can also include a set of ternary elements.⁵¹ (*Id.* claim 4.). These access control patterns are matched with a packet label to generate an access result. (*Id.* claim 1; JX-3 claim 46.). Next, the specification discloses that access control memory **210** includes content-addressable memory (CAM) having a sequence of access control specifiers **211**. (JX-5 at 4:34-36.). Each access control specifier **211** includes a label match mask **212** and a label match pattern **213**. (*Id.* at 4:36-38.). Both the label match mask **212** and the label match pattern **213** are made up of bits. (*Id.* at 4:38-43.). The CAM includes an array of ternary elements for matching logical “0,” logical “1,” or any value (i.e., don’t care value). (*Id.* at 2:51-54.). The specification also discloses that the bits of the label match pattern are compared with the corresponding bits of a packet label to generate a result of a match or no match. (*Id.* at 4:38-47; *see also id.* at 5:5-7.). Therefore, it is a finding of this decision that based on the claims and the specification, a person of ordinary skill in the art would understand “access control patterns” to mean “patterns of bits or other elements used for access control. *See Phillips*, 415 F.3d at 1312-18 (discussing the importance of the claims themselves and the specification in construing claim terms).

Staff’s proposal to add “and stored in an associative memory” to the construction is unnecessary. The claims expressly require that the access control patterns be stored in memory. (JX-5 claim 1 (“maintaining a set of access control patterns in at least one associative memory”); JX-3 claim 46 (same).). It would be redundant and therefore unnecessary to incorporate this requirement into the construction of the term “access control patterns.” *See HBAC Matchmaker Media, Inc. v. Google Inc.*, 650 F. App’x 990, 993 (Fed. Cir. 2016). In *HBAC*, the district court construed the term “head end system” to require a conventional TV system. *Id.* at 992. The

⁵¹ A bit is a binary element that can be one of two values often represented by “0” and “1.” A ternary element can be one of three values, for example, “0,” “1,” or “don’t care,” which can be “0” or “1.” (*Id.* at 2:51-54.).

Public Version

Federal Court found error in the district court's construction because certain claims specifically add a TV limitation. *Id.* at 993. "The district court's construction thus introduces avoidable redundancy into the language of the claims. We have repeatedly emphasized that a "claim construction that gives meaning to all the terms of the claim is preferred over one that does not do so." *Id.* (quoting *Merck & Co. v. Teva Pharm. USA, Inc.*, 395 F.3d 1364, 1372 (Fed. Cir. 2005)). Similarly here, adding "and stored in an associative memory" to the construction of "access control patterns" would add avoidable redundancy to the language of the claims. Moreover, Dr. Almeroth, Cisco's expert, testified during the hearing that the language "and stored in an associative memory" is unnecessary in the construction because the claim language already requires it. (Tr. (Almeroth) at 215:3-8.).

Arista's expert, Dr. Olivier, testified during the hearing that the term "access control patterns" is indefinite under 35 U.S.C. § 112 ¶ 2⁵² and fails the written description requirement under 35 U.S.C. § 112 ¶ 1.⁵³ (Tr. (Olivier) at 2829:8-18.). He testified that the specification never mentions "access control patterns" but instead describes "access control specifiers." (*Id.* at 2828:1-4.). He also noted that the two terms cannot refer to the same thing, because claim 29 requires translating a sequence of access control specifiers into a sequence of access control patterns. (*Id.* at 2828:21-2829:1.).

With regard to the written description requirement, "the test for sufficiency is whether the disclosure of the application relied upon reasonably conveys to those skilled in the art that the

⁵² "The specification shall conclude with one or more claims particularly pointing out and distinctly claiming the subject matter which the applicant regards as his invention." 35 U.S.C. § 112 ¶ 2.

⁵³ "The specification shall contain a written description of the invention, and of the manner and process of making and using it, in such full, clear, concise, and exact terms as to enable any person skilled in the art to which it pertains, or with which it is most nearly connected, to make and use the same, and shall set forth the best mode contemplated by the inventor of carrying out his invention." 35 U.S.C. § 112 ¶ 1.

Public Version

inventor had possession of the claimed subject matter as of the filing date.” *Ariad Pharm., Inc. v. Eli Lilly & Co.*, 598 F.3d 1336, 1351 (Fed. Cir. 2010) (en banc). Although the specification portion of the patents does not use the term “access control patterns,” the claims themselves explain the relationship between “access control patterns” and “access control specifiers.” Claims 28-31 of the ’577 patent disclose that access control specifiers are translated into access control patterns. (JX-5 claims 28-31; *see also* JX-3 claim 60-62.). Moreover, a plurality of access control specifiers may be translated into a single access control pattern. (JX-5 claim 31; JX-3 claim 62; *see also* JX-5 at 5:33-38.). Cisco’s technical expert, Dr. Almeroth, testified during the hearing that claims 1, 3, and 4, and column 4, lines 34 through 43 of the specification provides support for the meaning of “access control patterns.” (Tr. (Almeroth) at 215:17-217:6.). Claims 1, 3, and 4 describe the access control patterns as including a pattern of bits or “don’t care” values. (JX-5 at 7:34-58.). Figure 2 of the ’577 patent depicts access control patterns **213** and column 4, lines 34-43 describe the access control patterns as including bit patterns that are matched with the packet label. (*Id.* at 4:34-43, fig. 2.). Accordingly, the weight of the evidence from the intrinsic evidence in the claim language when coupled with Dr. Almeroth’s testimony evidence that the descriptions in the patents reasonably convey to those skilled in the art that the inventors of the patents had possession of the claimed invention including the access control patterns.

“[A] patent is invalid for indefiniteness if its claims, read in light of the specification delineating the patent, and the prosecution history, fail to inform, with reasonable certainty, those skilled in the art about the scope of the invention.” *Nautilus, Inc. v. Biosig Instruments, Inc.*, 134 S. Ct. 2120, 2124 (2014). Arista’s expert, Dr. Olivier, testified during the hearing that the word “patterns” is a group of bits and is not indefinite. (Tr. (Olivier) at 2935:21-2936:2.). He also

Public Version

acknowledged that the term “access control is whether to allow or disallow how to send packets form one point to another.” (*Id.* at 2936:7-10.). Despite knowing and understanding the meanings of “access control” and “patterns” clearly, and therefore not indefinite, Dr. Olivier nonetheless maintained during the hearing that the term “access control patterns” is indefinite. (*Id.* at 2935:6-9.). Contrary to Dr. Olivier’s opinion, Dr. David Cheriton, one of the inventors, testified during his June 1, 2015 deposition that he has an understanding of the term. (JX-23C at 137:2-8 (“Q. Do you have an understanding of what access control patterns are? A. Yes, I do. Q. And what’s your understanding? A. It’s a sequence of bits that encode the access information from presumably an access control list in an associative memory or content-addressable memory.”)). Additionally, Mr. Milind Kulkarni⁵⁴ and Mr. Hua Zhong, Arista engineering managers, gave testimony during their respective July 30, 2015 and July 17, 2015 depositions that clearly indicated they understood the meaning of the term “access control patterns.” (*See* JX-0031C at 96:24-97:1 [

] Therefore, a person of ordinary skill in the art would understand, with reasonable certainty, the scope of the term “access control patterns.” (*See* JX-5 at 2:51-54, 4:34-47, 5:5-7, claims 1, 4-5; JX-3 claim 46.).

⁵⁴ At the time of his testimony, Mr. Milind Kulkarni (“Mr. Kulkarni”) was a manager in software development at Arista. (JX-0031C at 34:1-4.).

Public Version

2. '577 Patent, Claim 2—“performing at least two of said steps of receiving, matching, selecting, and making a routing decision, in parallel using a pipeline technique”⁵⁵

Cisco’s Proposed Construction	Arista’s Proposed Construction	Staff’s Proposed Construction
<p>Plain and ordinary meaning. If the claim needs to be construed:</p> <p>“performing at least two of said steps of receiving, matching, selecting, and making a routing decision in a manner where a second step begins before the first is complete”</p>	<p>These terms are indefinite/not amenable to construction under 35 U.S.C. § 112 ¶ 2 at least because claim 1 precludes performing at least some of said steps in parallel.</p>	<p>Plain and ordinary meaning. If the claim needs to be construed:</p> <p>“performing at least two of said steps of receiving, matching, selecting, and making a routing decision in a manner where a second step begins before the first is complete”</p>

As explained below, the term “performing at least two of said steps of receiving, matching, selecting, and making a routing decision, in parallel using a pipeline technique” does not require a construction beyond the plain and ordinary meaning. The parties’ dispute is focused on the meaning of “in parallel using a pipeline technique.” Cisco and Staff contend that plain and ordinary meaning is appropriate. (CBr.II at 3; SBr.II at 7-8.). Arista argued that this term is indefinite under 35 U.S.C. § 112 ¶ 2. (RBr.II at 7 (citing Tr. (Olivier) at 2829:19-2830:8).).

Independent claim 1 of the ’577 patent recites several steps, including “receiving,” “matching,” “selecting,” and “making.” Claim 2, which depends from claim 1, requires performing at least two of those steps “in parallel using a pipeline technique.” The specification discloses that step 326 (i.e., the input access control element 120 determining the input

⁵⁵ Joint Claim Construction Report at Attach. A, p. 3.

Public Version

permission for the packet **130**) is preferably performed in parallel with step **325** (i.e., the routing element **110** determining a selected output interface for the packet **130**). (JX-5 at 6:40-46.). The specification does not mention the pipeline technique.

The IEEE⁵⁶ Standard Dictionary of Electrical and Electronics Terms (6th ed. 1996) defines “pipeline” as “[a] software or hardware design technique in which the output of one process serves as input to a second, the output of the second process services as input to a third, and so on, often with simultaneity within a single cycle time.” (CX-0235 at 779.). The IEEE dictionary also defines “pipelining” as “[p]arallel processing in which instructions are executed in an assembly-line fashion: consecutive instructions are operated upon in sequence, but with several being initiated before the first is complete” and as “[a] technique for operation in which each instruction is broken into multiple steps, which are performed by different portions of the computer. A typical instruction stream allows a different instruction to be at each step in the pipeline at any point in time, allowing multiple instructions to overlap execution.” (*Id.*).

Similarly, Modern Dictionary of Electronics (6th ed. 1997) defines “pipeline” as “[a] processor design approach whereby instruction execution takes place in a series of units arranged so that several units can be simultaneously processing the appropriate parts of several instructions” and “pipelining” as “[b]eginning one instruction sequence before another has been completed.” (CX-0234 at 751-52.). The Computer Desktop Encyclopedia (2d. ed. 1999) explains “pipeline processing” as “[a] category of techniques that provide simultaneous, or parallel, processing within the computer. It refers to overlapping operations by moving data or

⁵⁶ Institute of Electrical and Electronics Engineers (IEEE) is an association of technical professionals and develops technological industry standards. (See JX-4 at 2:1-3.). Cf. *Phillips*, 415 F.3d at 1322 (“Dictionaries or comparable sources are often useful to assist in understanding the commonly understood meaning of words and have been used both by our court and the Supreme Court in claim interpretation.”).

Public Version

instructions into a conceptual pipe with all stages of the pipe processing simultaneously. For example, while one instruction is being executed, the computer is decoding the next instruction.” (CX-1385 at 702.). During the hearing, Cisco’s expert, Dr. Almeroth, testified that Figure 3 illustrates a pipelining technique and column 6, lines 40-46 describes that at least two steps in Figure 3 are performed in parallel. (Tr. (Almeroth) at 220:20-221:20.). He also testified that the word “parallel” need not be defined. (*Id.* at 467:14-21.). Therefore, the pipeline technique is well known in the art for performing steps in parallel.

Dr. Olivier, Arista’s expert, testified during the hearing that the steps of claim 1 are performed in sequence and therefore “there’s no way to do these in parallel.” (Tr. (Olivier) at 2829:19-2830:8.). Accordingly, and based on Dr. James Olivier’s testimony, Arista argued that the “parallel” requirement of dependent claim 2 is “nonsensical.” (RBr.II at 7.). However, Arista’s argument is based on a narrow interpretation of “in parallel” that is contrary to the ’577 patent and the dictionaries in evidence.

In Arista’s view, two steps performed “in parallel” must be performed simultaneously, i.e., start at the same time and end at the same time. (*See id.*). In contrast, Cisco and Staff adopt a broader interpretation that simply requires some but not necessarily an entire overlap in time, i.e., the second step starts before the first step ends. (SBr.II at 7-8; CBr.II at 48.). The dictionary definitions are consistent with Cisco and Staff’s interpretation, because the definitions make it clear that that a pipeline comprises sequential steps and that the pipelining technique can perform those steps in parallel, i.e., overlapping in time. (CX-0235 at 779 (“the output of one process serves as input to a second”) (“consecutive instructions are operated upon in sequence, but with several being initiated before the first is complete”) (“allowing multiple instructions to overlap execution”); CX-0234 at 751-52 (“instruction execution takes place in a series”) (“[b]eginning

Public Version

one instruction sequence before another has been completed”); CX-1385 at 702 (“overlapping operations”).). *See Phillips*, 415 F.3d at 1322 (“Dictionaries or comparable sources are often useful to assist in understanding the commonly understood meaning of words and have been used both by our court and the Supreme Court in claim interpretation.”). Consistent with the cited dictionary definitions, the ’577 patent disclose a sequential series of steps in Figure 3 and discloses that at least steps 325 and 326 may be performed in parallel. (JX-5 at 6:40-46, 7:49-52, fig. 3.). Accordingly, claim 2 is not “nonsensical,” and Arista has failed to meet its burden and prove by clear and convincing evidence that claim 2 is indefinite.

3. ’853 Patent, Claim 46—“means for maintaining a set of access control patterns in at least one associative memory”⁵⁷

Cisco’s Proposed Construction	Arista’s Proposed Construction	Staff’s Proposed Construction
<p><u>Function</u>: maintaining a set of access control patterns in at least one associative memory.</p> <p><u>Structure</u>: one or more content-addressable memory units and a general-purpose processor, program and data memory, and mass storage (’853 Patent, Fig. 1 “CPU”; 5:21-25), executing operating system software (’853 Patent, 5:21-25; 1:33–37) performing the steps of recording and keeping up a set of access control patterns in at least one associative memory” (’853 Patent, Abstract; Fig. 2; 4:54-63; 5:33-46; 5:55-6:20)</p>	<p><u>Function</u>: maintaining a set of access control patterns in at least one associative memory</p> <p><u>Corresponding structure</u>: None - no structure or algorithm is provided to perform the recited function, therefore this term is indefinite/not amenable to construction under 35 U.S.C. § 112, ¶ 2 at least because “access control patterns” are not described in the specification.</p>	<p><u>Function</u>: maintaining a set of access control patterns in at least one associative memory</p> <p><u>Structure</u>: one or more content-addressable memory units of the type described in col. 6:54-55</p>

⁵⁷ Joint Claim Construction Report at Attach. A, p. 3.

Public Version

A patent claim limitation may be drafted in means-plus-function format pursuant to 35 U.S.C. § 112 ¶ 6.

An element in a claim for a combination may be expressed as a means or step for performing a specified function without the recital of structure, material, or acts in support thereof, and such claim shall be construed to cover the corresponding structure, material, or acts described in the specification and equivalents thereof.

35 U.S.C. § 112 ¶ 6. According to the Federal Circuit, “[t]he first step in construing a means-plus-function limitation is to identify the function explicitly recited in the claim.” *Asyst Techs., Inc. v. Empak, Inc.*, 268 F.3d 1364, 1369-70 (Fed. Cir. 2001). The next step “is to identify the corresponding structure set forth in the written description that performs the particular function set forth in the claim.” *Id.* Corresponding structure “must not only perform the claimed function, but the specification must clearly associate the structure with performance of the function.” *Cardiac Pacemakers, Inc. v. St. Jude Med., Inc.*, 296 F.3d 1106, 1113 (Fed. Cir. 2002).

There is no dispute that the function of this means-plus-function limitation of claim 46 of the '853 patent is “maintaining a set of access control patterns in at least one associative memory.” (CBr.II at 4; RBr.II at 8; SBr.II at 9.). With regard to the corresponding structure, the specification discloses that “the access control element is configured to store the access control specifiers.” (JX-3 at 2:46-47.). “The access control element **120** includes . . . an access control memory **210**.” (*Id.* at 4:42-44.). “The access control memory **210** includes a CAM (content-addressable memory) having a sequence of access control specifiers **211**.” (*Id.* at 4:54-56; *see also id.* at fig. 2.). Therefore, the specification clearly associates “the access control memory” as the structure that performs the function of this means-plus-function limitation.

Staff and Cisco propose that the one or more the content-addressable memory units,

Public Version

which are inside the access control memory, should be the corresponding structure. (SBr.II at 8-9; CBr.II at 4.). Such an interpretation is too narrow for reasons explained below. The specification of the '853 patent discloses “a preferred embodiment” in which “[t]he access control memory 210 includes a CAM (content-addressable memory) having a sequence of access control specifiers 211.” (JX-3 at 4:54-56.). However, the inclusion of a CAM in the access control memory in merely one exemplary embodiment disclosed in the specification, and thus it would be improper to import such limitation into the claims. *See Phillip*, 415 F.3d at 1323 (“avoid importing limitations from the specification into the claims”). Additionally, comparing other independent and dependent claims in this patent is instructive. Independent claim 1 recites that access control specifiers are in an access control element, whereas dependent claim 2 specifies that “said access control element is a content addressable memory.” (JX-3 at 7:63-64, 8:6-7.). Similarly, independent claim 17 recites that an access control element stores access control specifiers, whereas dependent claim 24 recites that the access control element comprises an access control memory, dependent claim 25 recites that the access control memory is a content-addressable memory, and dependent claim 26 recites that the access control memory stores the access control specifiers. (*Id.* at 8:60-61, 9:26-33.). Unlike dependent claims 2 and 26, independent claim 46 at issue merely recites “means for maintaining a set of access control patterns in at least one associative memory” without any mention of a content-addressable memory. (*Id.* at 49-50.). Therefore, claim 46 should be interpreted so that the content-addressable memory is not necessarily present in claim 46. *See Phillips*, 415 F.3d at 1314–15 (“Differences among claims can also be a useful guide in understanding the meaning of particular claim terms. For example, the presence of a dependent claim that adds a particular limitation gives rise to a presumption that the limitation in question is not present in the

independent claim.”) (citations omitted).

Additionally, Cisco’s expert, Dr. Almeroth, testified during the hearing that the corresponding structure includes “a general-purpose processor, program and data memory, and mass storage executing operating system software performing the steps of recording and keeping up a set of access control patterns in at least one associative memory.” (Tr. (Almeroth) at 258:5-12.). However, he provided no explanation during the hearing for this opinion. (*Id.*) Cisco’s initial post-hearing brief points to dependent claim 60 of the ’853 patent and dependent claim 29 of the ’577 patent in support of Dr. Almeroth’s opinion and argued that the function of “maintaining” in independent claim 46 includes the steps of “receiving,” “translating,” and “storing” recited in dependent claim 60.⁵⁸ (CBr.II at 4.). The fact that “receiving,” “translating,” and “storing” are recited in *dependent* claim 60 and not in independent claim 46 is a basis to reject Dr. Almeroth’s opinion, for the following reason. (*See* JX-3 at 10:49-50, 12:4-11.).

Generally, an independent claim should be interpreted broadly enough to encompass the specific limitations in its dependent claims but should not be interpreted so narrowly as to require the specific limitations in the dependent claims. *See* 37 C.F.R. § 1.75(c). “Under the doctrine of claim differentiation, each claim in a patent is presumptively different in scope.” *RF Delaware, Inc. v. Pac. Keystone Techs., Inc.*, 326 F.3d 1255, 1263 (Fed. Cir. 2003) (citation and quotation marks omitted). Therefore, “where some claims are broad and others are narrow, the narrow claim limitations cannot be read into the broad.” *Winbond Elecs. Corp. v. Int’l Trade Comm’n*, 4 F. App’x 832, 838–39 (Fed. Cir. 2001) (quoting *D.M.I., Inc. v. Deere & Co.*, 755 F.2d 1570, 1574 (Fed.Cir.1985)). Accordingly, the “maintaining” function of independent claim

⁵⁸ To the extent Cisco is proposing to construe the term “maintaining” in claim 46 of the ’853 patent, the time for proposing claim constructions has passed and Cisco is now precluded from proposing new constructions. (*See* CBr.II at 4; Supplemental Joint Claim Construction Chart at 9-10.).

46 *may* include the functions of “receiving,” “translating,” and “storing,” but does not necessarily *require* these three functions of dependent claim 60. *See Phillips v. AWH Corp.*, 415 F.3d 1303, 1315 (Fed. Cir. 2005) (“[T]he presence of a dependent claim that adds a particular limitation gives rise to a presumption that the limitation in question is not present in the independent claim.”). For this reason, “a general-purpose processor, program and data memory, and mass storage executing operating system software performing the steps of recording and keeping up a set of access control patterns in at least one associative memory,” which Dr. Almeroth opined are required to perform the “receiving,” “translating,” and “storing” functions of dependent claim 60, are not necessarily required for independent claim 46.

Lastly, Dr. Almeroth testified during the hearing that this term is not indefinite. (Tr. (Almeroth) at 2996:22-24.). Arista’s expert, Dr. Olivier, did not opine during the hearing that this term is indefinite. Nevertheless, Arista’s initial post-hearing brief argued that this means-plus-function limitation is indefinite under Cisco’s construction because “recording and keeping up a set of access control patterns in at least one associative memory” is not described in the patent. (*See* RBr.II at 8.). Arista’s argument is moot because that portion of Cisco’s proposed construction was rejected in this Initial Determination.

4. '853 Patent, Claim 46—*“means for receiving a packet label responsible to a packet, said packet label being sufficient to perform access control processing for said packet”*⁵⁹

Cisco’s Proposed Construction	Arista’s Proposed Construction	Staff’s Proposed Construction
<p><u>Function</u>: receiving a packet label responsive to a packet</p> <p><u>Structure</u>: access control</p>	<p><u>Function</u>: receiving a packet label responsible to a packet, said packet label being</p>	<p><u>Function</u>: receiving a packet label responsive to a packet</p> <p><u>Structure</u>: input port to an</p>

⁵⁹ Joint Claim Construction Report at Attach. A, p. 4.

Public Version

element's input port (Fig. 2, 201)	sufficient to perform access control processing for said packet <u>Corresponding structure:</u> None – no structure or algorithm is provided to perform the recited function, therefore this term is indefinite/not amenable to construction under 35 U.S.C. § 112, ¶ 2 at least because no structure is disclosed for “receiving a packet label responsible to a packet”	access control element of the type shown in Fig. 2 (element 201)
------------------------------------	---	--

Cisco's expert, Dr. Almeroth, testified during the hearing that the function of this means-plus-function element is “receiving a packet label responsive to a packet.” (Tr. (Almeroth) at 265:12-16.). Arista's expert, Dr. Olivier, did not opine on the construction of this limitation during the hearing. Arista proposes that the function is “receiving a packet label responsible to a packet, said packet label being sufficient to perform access control processing for said packet.” (Supplemental Joint Claim Construction Chart at 10 (June 19, 2015).).

However, in its initial post-hearing brief, Arista states that the function is not disputed. (RBr.II at 8.). Staff noted the differences in the proposed functions but believes there is no material dispute among the parties. (SBr.II at 7.). However, none of the parties presented any evidence or reasoning for whether “said packet label being sufficient to perform access control processing for said packet” should be part of the function of this limitation. This question is immaterial to the decision in this Initial Determination.

With respect to the corresponding structure, the specification discloses that “the routing element **110** selects portions of the header for use as the packet label **200**” and “couples the

Public Version

packet label **200** and the input interface specifier to the input access control element **120**.” (JX-3 at 6:56-57, 63-65.). More specifically, “[t]he access control element **120** includes an input port **201** coupled to the packet label **200**.” (*Id.* at 4:43-45; *see also id.* fig. 2 (depicting arrows from packet label **200** to input port **201** of access control element **120**)). Therefore, specification clearly links the input port of the access control element as the structure that performs the function of receiving a packet label responsive to a packet. Consistent with the patent, Cisco’s expert, Dr. Almeroth, opined during the hearing that the corresponding structure is “the access control element’s input port.” (Tr. (Almeroth) at 265:12-17.).

Arista’s position with respect to this limitation is unclear. In the Supplemental Joint Claim Construction Chart filed by the parties before the hearing, Arista’s position with respect to the corresponding structure of this limitation was “no structure or algorithm is provided to perform the recited function, therefore this term is indefinite/not amenable to construction under 35 U.S.C. § 112, ¶ 2 at least because no structure is disclosed for ‘receiving a packet label responsible to a packet.’” (Doc. ID No. 559136; Supplemental Joint Claim Construction Chart at 10 (June 19, 2015)). However, during the hearing, Dr. Olivier, Arista’s invalidity expert, did not specifically opine that this means-plus-function limitation is indefinite. (Tr. (Olivier) at 2788:21-2789:11.). Arista’s initial post-hearing brief likely does not argue that this limitation is indefinite under 35 U.S.C. § 112 ¶ 2 but rather that “Cisco and the Staff’s proposed corresponding structure is *improper and inadequate* for the reasons given above for ‘access control patterns.’” (*See* RBr.II at 8 (emphasis added)). Since Arista’s brief does not provide any explanation, it is unclear how the reasons Arista provided with regard to the term “access control patterns” relate to this means-plus-function limitation, which does not include that term. Accordingly, Arista has failed to meet its burden and prove by clear and convincing evidence

that this limitation is indefinite. *See Budde v. Harley-Davidson, Inc.*, 250 F.3d 1369, 1376–77 (Fed. Cir. 2001) (clear and convincing proof required to show indefiniteness of means-plus-function limitation).

5. '853 Patent, Claim 46—“*means for matching matchable information, said matchable information being responsive to said packet label, with said set of access control patterns in parallel*”⁶⁰

Cisco’s Proposed Construction	Arista’s Proposed Construction	Staff’s Proposed Construction
<p><u>Function</u>: matching matchable information, said matchable information being responsive to said packet label, with said set of access control patterns in parallel</p> <p><u>Structure</u>: access control memory (Fig. 2, 210), including one or more content-addressable memory units of the type shown in Fig. 2 (element 210)</p>	<p><u>Function</u>: matching matchable information said matchable information being responsive to said packet label, with said set of access control patterns in parallel</p> <p><u>Corresponding structure</u>: None - no structure or algorithm is provided to perform the recited function, therefore this term is indefinite/not amenable to construction under 35 U.S.C. § 112, ¶ 2 at least because “access control patterns” are not described in the specification.</p>	<p><u>Function</u>: matching matchable information said matchable information being responsive to said packet label, with said set of access control patterns in parallel</p> <p><u>Structure</u>: one or more content-addressable memory units of the type described in col. 6:54-55</p>

There is no dispute that the function of this means-plus-function limitation is “matching matchable information, said matchable information being responsive to said packet label, with said set of access control patterns in parallel.” (CBr.II at 5; RBr.II at 8; SBr.II at 13.) With regard to the corresponding structure, the specification discloses, “The access control element is configured . . . to match one or more characteristics of a packet with the access control

⁶⁰ Joint Claim Construction Report at Attach. A, p. 4.

specifiers.” (JX-3 at 2:46-49.). “At a step **326**, . . . the input access control element **120** determines the input permission for the packet **130**.” (*Id.* at 7:1-3.). Step **326**, which is performed by the input access control element **120**, “includes matching the packet label **200** against the access control memory **210**.” (*Id.* at 7:6-8; *see also id.* at 7:27-33.). Therefore, the specification clearly links the access control element as the structure that performs the matching function.

Dr. Almeroth, Cisco’s expert, testified during the hearing that the corresponding structure is “the access control memory, including one or more content-addressable memory units of the type shown in figure 2” without any explanation of the basis for his opinion. (Tr. (Almeroth) at 277:21-24.). The ’853 does not support Dr. Almeroth’s opinion, because the specification discloses that the access control memory and the content-addressable memory *store* access control specifiers, not match them with the packet label. (*See, e.g.*, JX-3 abs. (“access control specifiers . . . are recorded in a CAM”); *id.* at 4:54-56 (“The access control memory **210** includes a CAM (content-addressable memory) having a sequence of access control specifiers **211**”); *id.* at 5:4-7 (“the single access control specifier 211 with the highest priority (in a preferred embodiment, the one with the lowest address in the access control memory **210**”); *see also id.* claim 26 (“said access control memory stores at least one of said access control specifier”).).

Dr. Olivier, Arista’s invalidity expert, did not specifically opine during the hearing that this means-plus-function limitation is indefinite. (Tr. (Olivier) at 2788:21-2789:11.). Nevertheless, Arista’s initial post-hearing brief argued that this limitation is indefinite under 35 U.S.C. § 112 ¶ 2 “for the reasons given above for ‘access control patterns.’” (RBr.II at 8.). In other words, Arista argued that this limitation is indefinite “because ‘access control patterns’ are not described in the specification.” (Supplemental Joint Claim Construction Chart at 11.).

Public Version

However, that argument was rejected in this Initial Determination, because a person of ordinary skill the art would understand with reasonable certainty the scope of the term “access control patterns.” (*See supra* Section V.B.1 (citing JX-23C at 137:2-8; JX-31C at 96:24-97:1; JX-45C at 71:15-19)). Accordingly, Arista has failed to meet its burden and prove by clear and convincing evidence that this limitation is indefinite.

6. '853 Patent, Claim 46—“*means for generating a set of matches in response thereto, each said match having priority information associated therewith*”⁶¹

Cisco’s Proposed Construction	Arista’s Proposed Construction	Staff’s Proposed Construction
<p><u>Function:</u> generating a set of matches in response thereto, each said match having priority information associated therewith</p> <p><u>Structure:</u> access control memory (Fig. 2, 210), including one or more content-addressable memory units of the type shown in Fig. 2 (element 210)</p>	<p><u>Function:</u> generating a set of matches in response thereto, each said match having priority information associated therewith</p> <p><u>Corresponding structure:</u> access control memory 210, including one or more of the content-addressable memory units as configured in Fig. 2; 4:54-6</p>	<p><u>Function:</u> generating a set of matches in response thereto, each said match having priority information associated therewith</p> <p><u>Structure:</u> one or more content-addressable memory-units of the type described in col. 4:54-56</p>

There is no dispute that the function of this means-plus-function limitation is “generating a set of matches in response thereto, each said match having priority information associated therewith.” (CBr.II at 5; RBr.II at 8; SBr.II at 14.). With regard to the corresponding structure, the specification discloses that “[t]he access control element . . . match[es] one or more characteristics of a packet with the access control specifiers,” and then “the priority encoder . . . select[s] the highest priority match from among the matches” generated by the access control

⁶¹ Joint Claim Construction Report at Attach. A, p. 5.

Public Version

element. (JX-3 at 2:46-51.). Furthermore, step **326**, which is performed by the access control element **120**, includes “determining all of the successful matches” and “coupling the successful matches to the priority encoder **220**.” (*Id.* at 7:8-10.). Therefore, the patent clearly links the access control element as the structure that performs the function of generating a set of matches.

Dr. Almeroth testified during the hearing that the corresponding structure for this limitation is access control memory including one or more content-addressable memory units of the type shown in Figure 2, but did not provide any explanation of the basis for his opinion. (Tr. (Almeroth) at 278:14-23.).

The '853 patent does not support Dr. Almeroth's opinion, because the specification discloses that the access control memory and the content-addressable memory *store* access control specifiers, not generate matches. (*See, e.g.*, JX-3 abstract (“access control specifiers . . . are recorded in a CAM”); *id.* at 4:54-56 (“The access control memory **210** includes a CAM (content-addressable memory) having a sequence of access control specifiers **211**”); *id.* at 5:4-7 (“the single access control specifier 211 with the highest priority (in a preferred embodiment, the one with the lowest address in the access control memory **210**”); *see also id.* claim 26 (“said access control memory stores at least one of said access control specifier”). *See Cardiac Pacemakers*, 296 F.3d at 1113 (“[T]he specification must clearly associate the structure with performance of the function.”).

7. **'853 Patent, Claim 46**—“*means for selecting at least one of said matches in response to said priority information, and generating an access result in response to said at least one selected match*”⁶²

Cisco's Proposed Construction	Arista's Proposed	Staff's Proposed Construction
-------------------------------	-------------------	-------------------------------

⁶² Joint Claim Construction Report at Attach. A, p. 5.

Public Version

	Construction	
<p><u>Function:</u> (1) selecting at least one of said matches in response to said priority information and (2) generating an access result in response to said at least one selected match</p> <p><u>Structure:</u> priority encoder (Fig. 2, 220)</p>	<p><u>Function:</u> selecting at least one of said matches in response to said priority information</p> <p><u>Corresponding structure:</u> priority encoder 220; 5:1-20</p>	<p><u>Function:</u> (1) selecting at least one of said matches in response to said priority information, and (2) generating an access result in response to said at least one selected match</p> <p><u>Structure:</u> priority encoder of the type set forth in Fig. 2 (element 220) and described in col. 5:1-20</p>

There is no dispute that the function of this means-plus-function limitation is “selecting at least one of said matches in response to said priority information and generating an access result in response to said at least one selected match.” (CBr.II at 6; RBr.II at 9; SBr.II at 15-16.).

Moreover, there is no dispute that the structure corresponding to the “selecting” function is the priority encoder. (CBr.II at 6; RBr.II at 8; SBr.II at 15-16.). The dispute centers on whether the specification sufficiently discloses the structure corresponding to the function of generating an access result to render the term indefinite. (RBr.II at 8.).

The specification discloses that “[t]he priority encoder **220** selects the single access control specifier **211** with the highest priority . . . and provides an indicator of that single access control specifier **211** to the output port **202**. The indicator . . . specifies whether or not the packet **130** has permission to be forwarded . . . to its specified destination device **132**.” (JX-3 at 5:1-13; *see also id.* fig. 2, item 220.). “The priority encoder is configured to select the highest priority match from among the matches.” (*Id.* at 2:50-51.). “Successful matches are input to a priority selector, which selects the match with the highest priority (that is, the match that is first in the sequence of access control specifiers). The specified result of the selected match is used to

Public Version

permit or deny access for the packet.” (*Id.* abstract.). Additionally, claim 17 recites that “said priority encoder is configured to select a highest priority match based on the priority of the types of access control specifiers.” Dr. Almeroth testified during the hearing that the corresponding structure for the selecting and generating functions is the priority encoder. (Tr. (Almeroth) at 349:14-22.). Therefore, at least according to Cisco’s expert, the patent clearly links the priority encoder as the structure that performs both the “selecting” and “generating” functions.

Dr. Olivier, Arista’s invalidity expert, testified during the hearing that this limitation is indefinite because, in his opinion, the patent does not disclose the structure that performs the generating function. (Tr. (Olivier) at 2789:16-22 (“[T]he result is not shown anywhere in the -- stored anywhere in the ’853 patent. And there is no -- all we know is that something generates the access result. We don’t know whether it’s done by the priority encoder, whether it’s done by the memory or some other elements. There’s just no teaching of how the results generated based on the result of the match.”)). Based on Dr. Olivier’s testimony, Arista argued that the patent fails to teach the structure for the generating function. (RBr.II at 9.). Arista recognizes that the patent describes the priority encoder providing an indicator of a single access control specifier but argued that an indicator is not an access result. (*Id.*). Dr. Olivier appears to draw a distinction between the “indicator” described in the specification and the claimed “access result.” (*Id.*). However, as described in the specification, the result of the matching process is an indicator of a single access control specifier that specifies whether the packet can be forwarded to the destination or dropped. (JX-5 at 2:50-51, 5:1-13.). Therefore, the indicator is a disclosed example of the claimed “access result.” Accordingly, since the specification discloses the priority encoder as the structure that provides the indicator, the specification identifies the priority encoder as the structure that performs the generating function.

Public Version

Dr. Olivier also testified during the hearing that he “could find no circuitry, no algorithm, no logic anywhere in the ’853 patent that describes how” the generating function is performed. (Tr. (Olivier) at 2789:1-5.). According to Dr. Olivier, “[t]he priority encoder is simply shown as a black box.” (*Id.* at 2791:17-18.). However, when cross-examined, Dr. Olivier admitted that a “[p]riority encoder is understood by one of ordinary skill in the art.” (*Id.* at 2943:19-20). Additionally, Dr. David Cheriton (one of the two inventors) and Dr. Hugh Holbrook⁶³ (Vice President of Software Engineering at Arista) testified during their respective June 1, 2015 and June 24, 2015 depositions that a priority encoder is standard hardware that college engineering students would understand. (JX-0023C at 126:7-10 (“[T]he priority encoder is a pretty standard hardware module, so I think if they took a first class in digital logic in college, they would be told how to do that.”); *id.* at 127:23-24 (“[T]here’s circuitry inside of the priority encoder that looks at all the inputs, and . . . the sort of first or highest priority input that’s active . . . disables the input from all of the other inputs.”); JX-0026C at 383:16-19 (“So there are particular hardware structures that one learns about in . . . engineering that’s something called a priority encoder.”)).

Accordingly, the patent need not explain the internal structure of a priority encoder. *See Nautilus*, 134 S. Ct. at 2128 (patents are addressed to those skilled in the relevant art); *Tech. Licensing Corp. v. Videotek, Inc.*, 545 F.3d 1316, 1338 (Fed. Cir. 2008) (“[T]he absence of internal circuitry in the written description does not automatically render the claim indefinite.”);

⁶³ At the time of his testimony, Dr. Hugh Holbrook (“Dr. Holbrook”) was Vice President of Software Engineering at Arista. (JX-0026C at 81:10-11.). Arista designated Mr. Holbrook as a fact witness to provide testimony regarding: (1) Arista and its history; (2) design, development, and operation of the accused products, including but not limited to features such as access control lists, control plane protection, and/or multi-chasses link aggregation; (3) any Arista interactions with Cisco; and (4) Arista’s knowledge of the asserted patents. (RPSt. at 2.).

Public Version

S3 Inc. v. NVIDIA Corp., 259 F.3d 1364, 1370 (Fed. Cir. 2001) (means for selectively receiving was not indefinite, even though the specification did not describe the electronic structure of the selector and the details of its electronic operation, where a selector is a standard electronic component whose structure is well known in this art). The evidence therefore does not clearly and convincingly support Arista’s assertion that this limitation is indefinite under 35 U.S.C. § 112 ¶ 2.

8. ’853 Patent, Claim 46—“means for making a routing decision in response to said access result”⁶⁴

Cisco’s Proposed Construction	Arista’s Proposed Construction	Staff’s Proposed Construction
<p><u>Function</u>: making a routing decision in response to said access result</p> <p><u>Structure</u>: (1) output port (Fig. 2, 202) and priority encoder (Fig. 2, 220) and/or (2) a general-purpose processor, program and data memory, and mass storage (’853 Patent, Fig. 1 “CPU”; 5:21-25), executing operating system software (’853 Patent, 5:21-25; 1:33–38) performing at least the step of comparing a packet to administrative policies or restrictions (’853 Patent, 5:25-30)</p>	<p><u>Function</u>: making a routing decision in response to said access result</p> <p><u>Corresponding structure</u>: None - no structure or algorithm is provided to perform the recited function, therefore this term is indefinite/not amenable to construction under 35 U.S.C. § 112, ¶ 2 at least because the patent fails to disclose any structure that makes a “routing decision.”</p>	<p><u>Function</u>: making a routing decision in response to said access result</p> <p><u>Structure</u>: a priority encoder of the type set forth in Fig. 2 (element 220) and described in col. 5:1-20</p>

There is no dispute that the function of this means-plus-function limitation is “making a routing decision in response to said access result.” (CBr.II at 6; RBr.II at 10; SBr.II at 19.).

⁶⁴ Joint Claim Construction Report at Attach. A, p. 5.

Public Version

In reviewing the specification for the structure that performs this function, it is important to note that the parties agreed that the term “making a routing decision in response to said access result” means “making a decision on *whether, how, and/or where* to route a packet in response to said access result.” (SBr.II at 5 (emphasis added)). The specification discloses that a routing element receives a packet and determines an output interface to which the packet should be forwarded. (JX-3 at 6:52-53 (“At a step **321**, the routing element **110** receives an input packet **130**.”); *id.* at 6:66-67 (“At a step **325**, the routing element **110** determines a selected output interface for the packet **130**.”); *id.* at 3:50-53 (“The routing element **110** processes each packet **130** to select one or more of the output interfaces **102** to which the packet **130** should be forwarded.”)). Therefore, at least the routing element makes a routing decision because it decides *where* to route a packet, consistent with the agreed-upon construction. There is no disclosure in the specification that the routing decision by the routing element is made “in response to said access result,” as the function at issue requires.

The '853 patent discloses that the routing decision made by a routing element (i.e., a router) can be overridden by a routing decision made by the access control element:

[T]he invention can be used to augment or override routing decisions otherwise made by the router, using the access control element **120**. In addition to specifying that the packet **130** is to be dropped or forwarded to the higher-level processor, the access control element **120** can alter the output interface, which was selected by the routing element **110**, to another selected output interface.

(*Id.* at 6:33-40.). That is, “[t]he access control element **120** . . . perform[s] access control after a routing decision has been made” by the routing element. (*Id.* at 3:64-4:1.). For example, the access control element can deny transmission of a packet to the destination determined by the routing element. (*Id.* at 4:2-5 (“[T]he access control element **120** is still capable of denying access to packets **130** responsive to whether they have permission to be forwarded from their

Public Version

source devices **131** at all.”); *see also id.* at 7:19-23, 27-30, 46-50.). Or the access control element may permit transmission of the packet to one of the output interfaces determined by the routing element. (*Id.* at 7:51-52.). Therefore, the access control element makes a routing decision at least because it decides *whether* to route a packet, consistent with the agreed-upon construction.

Additionally, the access control element makes a routing decision “in response to said access result,” as the claimed function requires. For example, “[t]he step **326** includes . . . matching the packet label **200** against the access control memory **210** . . . , determining all of the successful matches, . . . , determining the highest-priority match, and providing an output result from the input access control element **120**.” (*Id.* at 7:6-12.). At step **328**, the output access control element **120** may determine that the packet **130** should be dropped. (*Id.* at 7:46-50; *see also id.* abstract (“The specified result of the selected match is used to permit or deny access for the packet.”)). Therefore, the specification clearly links the access control element as the corresponding structure for this means-plus-function limitation. *See Cardiac Pacemakers*, 296 F.3d at 1113 (“[T]he specification must clearly associate the structure with performance of the function.”).

Consistent with Cisco’s and Staff’s proposed structure for this limitation, Dr. Almeroth, Cisco’s expert, testified during the hearing that the corresponding structure includes the priority encoder. (Tr. (Almeroth) at 545:19-546:1.). However, as explained above, the specification discloses that the priority encoder selects the highest priority one of multiple matching access control specifiers. (JX-3 at 2:50-51, 5:1-13.). The specification also discloses that access control element makes a routing decision in response to the selected access control specifier. (*Id.* 7:6-12, 46-50, abstract.). The specification does not disclose that the priority encoder makes a routing

decision. As Dr. Almeroth explained during the hearing that priority encoder merely outputs the access result but does not making a routing decision. (Tr. (Almeroth) at 548:15-549:2 (“[Y]ou have the result coming out of the priority encoder, and it still has to go into the routing process and so the routing process will be making its own determination.”)).

Dr. Almeroth testified during the hearing that the corresponding structure also includes general-purpose processor, program and data memory, and mass storage executing operating system software performing at least the step of comparing a packet to administrative policies or restrictions. (Tr. (Almeroth) at 545:19-546:1.). The specification discloses:

The higher-level processor includes a general-purpose processor, program and data memory, and mass storage, executing operating system and application software for software (rather than hardware) examination of the packet **130**. The packet **130** is compared, possibly to the access control specifiers **211** and possibly to other administrative policies or restrictions, by the higher-level processor.

(JX-3 at 5:21-27.). Therefore, Dr. Almeroth’s opinion is that the higher-level processor should be included in the corresponding structure.

The specification describes a scenario in which the access control element determines that a higher-level processor should process the packet to enforce administrative policies. (*Id.* at 5:10-30, 6:33-42, 7:13-23, 40-50.). However, the specification discloses this scenario involving the higher-level process as an alternative embodiment (i.e., an optional scenario). (*See id.* at 5:17 (“or”); *id.* at 7:13 (“If”); *id.* at 7:47 (“or”).). Nothing in the language of claim 46 requires processing by a higher-level processor. (*See id.* claim 46.). Indeed, the fact that dependent claims 12, 28, and 43 require a higher-level processor suggests that independent claim 46 does not. *See id.* claims 12, 28, 43; *Phillips*, 415 F.3d at 1315 (“[T]he presence of a dependent claim that adds a particular limitation gives rise to a presumption that the limitation in question is not present in the independent claim.”).

Public Version

Dr. Almeroth testified during the hearing that the corresponding structure includes the output port. (Tr. (Almeroth) at 545:19-546:1.). However, the specification discloses that the output port is used by the access control element to output the indicator and the packet. (JX-3 at 4:43-46, 5:4-13, fig. 2, item 202, claim 29.). There is no disclosure in the specification that the output port itself makes a routing decision. In support of this, Dr. Almeroth acknowledged during the hearing that the output port merely provides a transition or a connection between the priority encoder and the next processor. (Tr. (Almeroth) at 553:24-556:7.).

Dr. Olivier, Arista's invalidity expert, testified during the hearing that this term is indefinite because he "could find no function, no circuitry, no algorithm describing how this function takes place." (Tr. (Olivier) at 2789:6-11.). Specifically, he looked at Figure 2 of the '853 patent and opined, "Well, there's nothing showing making a routing decision and access result. The only box we have here is an output port, but it literally is just a black box. We don't know how it makes a routing decision. So there is nothing shown performing a routing decision after the access control element." (*Id.* at 2790:8-13.). Although Dr. Olivier argued that the output is a black box, his opinion is not relevant because the output port is not the correct corresponding structure for this limitation; the access control element is the corresponding structure as explained above. (*See* JX-3 at 3:64-4:5, 6:33-40, 7:6-12, 19-23, 27-30, 46-52.). Moreover, his opinion that Figure 2 of the '853 patent does not show what is performing a routing decision *after* the access control element is equally unavailing, because the access control element *is* the structure performing the function of making a routing decision. (*See id.*).

Arista's initial post-hearing brief points out that the Patent Trial and Appeal Board ("PTAB") found this means-plus-function limitation indefinite because it is unclear which part of the access control element is implemented in hardware versus software. (RBr.II at 10 (citing

Public Version

Arista Networks, Inc. v. Cisco Sys., Inc., IPR2015-00976, 2015 WL 7304073 (Oct. 19, 2015)).

However, neither the PTAB's decision nor Arista's brief cites any authority that requires a patent to specify which steps are executed by hardware and which steps are executed by software. (See *Arista*, 2015 WL 7304073; RBr.II at 10.). Where a claim includes means-plus-function limitations, the specification or the prosecution history must clearly link or associate the disclosed structure to the function recited in the claim. *Noah Sys., Inc. v. Intuit Inc.*, 675 F.3d 1302, 1311 (Fed. Cir. 2012). As explained above, the '853 patent clearly links the access control element as the structure corresponding to the claimed function. (See JX-3 at 3:64-4:5, 6:33-40, 7:6-12, 19-23, 27-30, 46-52.). Moreover, the internal structure of the access control element and the processes it performs are illustrated and described in detail throughout the '853 patent. (See *id. passim.*). Additionally, Arista provides no authority for the proposition that PTAB's denial of IPR institution based on the PTAB's inability to sufficiently determine the scope of the claim to find that "there is a reasonable likelihood that the petitioner would prevail" on a prior art-based invalidity challenge, 35 U.S.C. § 314(a), satisfies the clear and convincing proof required to find indefiniteness. (See RBr.II at 10-11.).

For the above reasons, Arista has not proven by clear and convincing evidence that this limitation is indefinite. See *Budde*, 250 F.3d at 1376-77 (clear and convincing proof required to show indefiniteness of means-plus-function limitation).

C. Infringement

As discussed below, the evidence establishes that Arista's products practice claims 1, 7, 9-10, and 15 of the '577 patent and that Arista indirectly infringes the patent.

1. Accused ACL Products

Cisco accuses Arista’s network switches⁶⁵ 7010, 7048, 7050, 7050X, 7150, 7250X, 7280E, 7300, 7300X, and 7500E (“Accused ACL Products”) of infringing claims 1, 2, 7, 9-10, and 15 of the ’577 patent and claims 46 and 63 of the ’853 patent. (CBr.II at 7; *id.* attaches. K-L). The Accused ACL Products include one of four circuit chips: (1) Strata; (2) Petra; and (3) Arad, all of which are manufactured by Broadcom Corp.; and (4) Alta, which is manufactured by Intel Corp., as shown in the below chart. (*Id.* at 7.).

Table of Accused Arista ACL Products with Associated Chips

Accused ACL Product	Chip Family
7280E	Broadcom’s Arad
7500E	
7010	Broadcom’s Strata
7050	
7050X	
7250X	
7300	
7300X	
7048	Broadcom’s Petra
7150	Intel’s Alta

(*Id.* at Attach. L.). Broadcom and Intel make these off-the-shelf chips that Arista buys and incorporates into its network switches. (Tr. (Cordell) at 69:5-16.).

2. Claim 1 of the ’577 Patent

The only dispute with regard to the infringement of claim 1 is whether the Accused ACL Products practice the “in parallel” limitation of claim 1. The preponderance of evidence establishes that all four types of chips, Strata, Petra, Arad, and Alta, meet this limitation.

⁶⁵ A network switch is a common gateway device through which multiple computers and other devices in a local area network talk to one another. (RPBr. at 8.).

a) **Strata**

[

]

Dr. Hugh Holbrook, VP of Software Engineering at Arista, testified in a deposition on June 24, 2015, that [

] (JX-0026C at 271:6-

9.). Mr. Andreas Bechtolsheim testified during his deposition on May 29, 2015, that [

⁶⁶ A slice (also known as a bank) is a collection of rules stored within a region inside a CAM. (CX-0117C at 60.).

]

(*Id.* at 163:2-5.). Therefore, two Arista engineers—Dr. Holbrook and Mr. Bechtolsheim—confirmed that the rules in the accused chips are matched at the same time.

Contrary to compelling evidence in Broadcom documents and Dr. Holbrook’s and Mr. Bechtolsheim’s testimony that Strata performs parallel matching, one Broadcom document indicates otherwise. [

] (CX-0115C at 20.). Therefore, this document seems to indicate that matching is performed in sequence, not in parallel. However, none of the parties offers a persuasive explanation for the apparent contradictory statements in the Broadcom documents.

The weight of evidence favors a finding of infringement. The admissions by Arista’s own engineers (*see* JX-0026C at 271:6-9; JX-0021C at 139:2-5, 163:2-5) as well as at least three (3) of [] documents (*see* CX-0117C at 60; CX-0100C at 13; CX-0491C at 689) showing that Strata performs matching in parallel are sufficient proof of infringement. [

] Therefore, the preponderance of evidence shows that Strata practices the “in parallel” claim limitation. *See Warner-Lambert Co. v. Teva Pharm. USA, Inc.*, 418 F.3d 1326, 1341 n.15 (Fed. Cir. 2005) (“A claim for patent infringement must be proven by a preponderance of the evidence, which simply requires proving that infringement was more likely than not to have occurred.”) (citation omitted).

b) Petra

[] (CX-0108C at 77.). Cisco's expert, Dr. Almeroth, testified during the hearing that [] (Tr. (Almeroth) at 288:9-19.). Therefore, the evidence shows that Petra performs parallel matching.

Arista's non-infringement expert, Dr. Olivier, testified during the hearing that [] (Tr. (Olivier) at 2785:3–2787:1.). [] (*Id.* at 2917:4–2918:3.).

Based on Dr. Olivier's testimony, Arista did not dispute that Petra matches some rules in parallel but argued that Petra does not satisfy the claim requirement that *all* access control patterns must be matched in parallel. (RRBr.II at 10.).

Arista's interpretation of the claim is unduly narrow. Claim 1 of the '577 patent is an open-ended claim, as signaled by the use of the transition word "including" in the preamble. *See Mars, Inc. v. H.J. Heinz Co., L.P.*, 377 F.3d 1369, 1375-76 (Fed. Cir. 2004). An open-ended claim is infringed so long as each of the required limitations is satisfied, even if additional unclaimed elements are present in the accused device or process. *David Netzer Consulting Eng'r LLC v. Shell Oil Co.*, 824 F.3d 989, 998 (Fed. Cir. 2016); *Free Motion Fitness, Inc. v. Cybex Int'l, Inc.*, 423 F.3d 1343, 1347 (Fed. Cir. 2005); *Free Motion*, 423 F.3d at 1350; *Crystal Semiconductor Corp. v. TriTech Microelectronics Int'l, Inc.*, 246 F.3d 1336, 1347 (Fed. Cir. 2001) (Indefinite articles "a" and "an" in an open-ended claim means "one or more" or "at least one.").

Public Version

Applying these principles, an accused process would practice the claimed step of “maintaining a set of access control patterns” so long as at least one set of access control patterns are maintained. *See Free Motion*, 423 F.3d at 1350. Similarly, the accused process would practice the claimed step of “matching . . . with said set of access control patterns in parallel” so long as at least *one* set of access control patterns are matched in parallel. *See id.* Even if the accused process maintains multiple sets of access control patterns and some of those sets are not matched in parallel, infringement would still exist if one set of access control patterns is maintained and matched in parallel. *See id.*

Here, as discussed above, the documentary (*see* CX-0108C at 77) and testimonial (*see* Tr. (Almeroth) at 288:9-19) evidence show that [

] Dr. Olivier’s testimony

(*see* Tr. (Olivier) at 2785:3–2787:1, 2917:4–2918:3) that [

] does not defeat infringement. *See Free Motion*,

423 F.3d at 1350. Accordingly, the preponderance of evidence establishes that Petra practices this claim limitation.

c) Arad

[

] (CX-0300C at 323.). [

(CX-0104C at 34.). Cisco's expert, Dr. Almeroth, testified during the hearing that [

(*Id.* at 269:17-271:24.). Additionally, Arista's manager of software development, Mr. Milind Kulkarni, testified during his deposition on July 30, 2015, [

] (JX-0031C at 106:7–107:20.). Therefore, the evidence shows that

[] performs parallel matching.

[

] Moreover, the testimonies of at least three Arista engineers (i.e., Dr. Holbrook, Mr. Bechtolsheim, and Mr. Kulkarni), one of whom is an author of the SandAcl article, supports finding infringement. (See JX-0021C at 139:2-5, 163:2-7; JX-0026C at 271:1-9; JX-0031C at 106:7-107:20.).

Arista's expert, Dr. Olivier, testified during the hearing that [

] and thus does not infringe claim 1. (Tr. (Olivier) at 2780:10-18.). [

] (*See id.* at 2785:3-2787:1.).

First, Dr. Olivier testified that this [

] (*Id.* at 2920:8-15.). Therefore, Arad infringes claim 1 at least

based on its processing of egress ACLs. Second, [

] (*Id.* at 2917:4-2918:3; CX-0104C at

34.).

For these reasons, the weight of the evidence establishes that Arad practices the "in parallel" limitation.

d) Alta

While the documents relating specifically to Alta do not clearly disclose whether matching is performed in parallel (*see, e.g.*, CX-0090C at 62; CX-0052C at ANI-ITC-944 945-0717806.), there is other evidence that does. For example, Cisco's expert, Dr. Almeroth, testified during the hearing that Alta performs matching in parallel based on his review of the documentary evidence. (Tr. (Almeroth) at 276:2-9.). Arista's expert, Dr. Olivier, testified

⁶⁷ [

]

during the hearing that Alta search multiple CAM slices in a “cascading” or “chaining” fashion, but he did not dispute Dr. Almeroth’s testimony that the rules within a single CAM slice are matched in parallel. (Tr. (Olivier) at 2767:1-19.).

However, based on Dr. Olivier’s testimony that multiple CAM slices are chained in a cascading manner such that one slice is matched after another, Arista argued that Alta cannot infringe the claim, which requires parallel matching. (RBr.II at 14 (citing Tr. at 2774:2-21); RRBr.II at 8 (citing Tr. 2776:7–2777:6).). Even if multiple CAM slices are required for access control, Arista’s interpretation of the claim is unduly narrow. Claim 1 of the ’577 patent recites “matching matchable information . . . with said set of access control patterns in parallel” and “generating a set of matches in response thereto.” (JX-5 at 7:40-43.). Arista appears to interpret the phrase “in response thereto” to mean “*only* in response thereto” but provides no justification for such a restrictive interpretation. Indeed, Arista’s own expert, Dr. Olivier admitted during the hearing that a hypothetical CAM with four slices would satisfy the claim so long as one slice is matched in parallel even if the other slices are not. (Tr. (Olivier) at 2864:7-2865:3.). Therefore, Arista’s narrow claim interpretation is unsupported. According, Cisco has proven by a preponderance of the evidence that Alta satisfies the “in parallel” requirement of the claim. *See Enercon*, 151 F.3d at 1384 (infringement must be proved by preponderance of evidence).

3. Claim 2 of the ’577 Patent

Claim 2 of the ’577 patent requires “performing at least two of said steps of receiving, matching, selecting, and making a routing decision, in parallel using a pipeline technique.” The evidence does not establish that the Accused ACL Products infringe claim 2.

Arista’s motion to strike Cisco’s expert Dr. Almeroth’s hearing testimony with regard to the alleged infringement of claim 2 was granted. Therefore, Cisco cannot rely on Dr. Almeroth’s

hearing testimony as proof of infringement. Cisco's post-hearing briefs rely on several documents in support of the alleged infringement of claim 2. (CBr.II at 24; CRBr.II at 23-24.). Since Dr. Almeroth's hearing testimony has been stricken, Cisco's citations to numerous documents without an explanation of how the documentary evidence corresponds to the specific limitations of claim 2 fail to satisfy the burden of proving infringement, especially in view of Staff's objection. (See SBr.II at 31.). See *Canton Bio Med., Inc. v. Integrated Liner Techs., Inc.*, 216 F.3d 1367, 1370 (Fed. Cir. 2000) ("each of the claimed steps of a patented process must be performed in an infringing process"). Therefore, Cisco fails to meet its burden of proving by a preponderance of the evidence that the Accused ACL Products infringe claim 2.

4. Claims 7, 9-10, and 15 of the '577 Patent

There is no dispute that weight of evidence establishes that the Accused ACL Products meet the additional limitations of dependent claims 7, 9-10, and 15 of the '577 patent. (CBr.II at 24-25; RBr.II at 20; SBr.II at 31-32.). Therefore, Cisco has proven by a preponderance of the evidence that the Accused ACL Products infringe claims 7, 9-10, and 15 of the '577 patent.

5. Claim 46 of the '853 Patent.

Independent claim 46 of the '853 patent includes means-plus-function limitations whose recited functions mirror the steps recited in claim 1 of the '577 patent. (*Compare* JX-3 at 10:38-65 *with* JX-5 at 7:35-48.). For reasons explained below, the evidence does not establish that the Accused ACL Products practice claim 46 of the '853 patent.

a) "means for maintaining a set of access control patterns in at least one associative memory"

Arista did not dispute that the Accused ACL Products meet this limitation. (RBr.II at 20-24.). Staff's argument that Cisco failed to show infringement under its own proposed

Public Version

construction (*see* SRBr.II at 21) is not relevant because Cisco's proposed construction was rejected in this Initial Determination. (*See supra* Section V.B.3.). Therefore, it is undisputed that Cisco has proven by preponderance of evidence that the Accused ACL Products meet this limitation under the proper construction determined by the ALJ.

- b) **“means for receiving a packet label responsible to a packet, said packet label being sufficient to perform access control processing for said packet”**

There is no dispute that Cisco has proven that the Accused ACL Products meet this limitation. (CBr.II at 8; RBr.II at 20-24; SBr.II at 33.).

- c) **“means for matching matchable information, said match able information being responsive to said packet label, with said set of access control patterns in parallel”**

As discussed above in Section V.B.5, Cisco's and Staff's proposed corresponding structures for this limitation were rejected, and the correct corresponding structure was found to be “the access control element.” Therefore, even if Cisco sufficiently showed that the Accused ACL Products include Cisco's and Staff's proposed structures, Cisco failed to meet its burden of showing that the Accused ACL Products include a structure that is identical or equivalent to the access control element disclosed in the specification. *See MobileMedia Ideas LLC v. Apple Inc.*, 780 F.3d 1159, 1170 (Fed. Cir.) (“Literal infringement of a § 112 ¶ 6 limitation requires that the relevant structure in the accused device perform the identical function recited in the claim and be identical or equivalent to the corresponding structure in the specification.”), *cert. denied*, 136 S. Ct. 270 (2015).

- d) **“means for generating a set of matches in response thereto, each said match having priority information associated therewith”**

As discussed above in Section V.B.6, Cisco's and Staff's proposed corresponding

Public Version

structures for this limitation have been rejected, and the correct corresponding structure was found to be “the access control element.” Therefore, even if Cisco sufficiently showed that the Accused ACL Products include Cisco’s and Staff’s proposed structures, Cisco failed to meet its burden of showing that the Accused ACL Products include a structure that is identical or equivalent to the access control element disclosed in the specification.

- e) **“means for selecting at least one of said matches in response to said priority information, and generating an access result in response to said at least one selected match”**

There is no dispute that Cisco has proven that the Accused ACL Products practice the recited function of this limitation based on the same evidence Cisco adduced for a corresponding step in claim 1 of the ’577 patent. (CBr.II at 21-23; RBr.II at 20-24; SBr.II at 33-35.).

This Initial Determination in Section V.B.7 held that the corresponding structure of this limitation is the priority encoder, consistent with the parties’ agreement. Cisco’s expert, Dr. Almeroth, testified during the hearing that the Accused ACL Products include a priority encoder that meets this limitation. (Tr. (Almeroth) at 344:25-345:4.). Specifically, Dr. Almeroth identified the specific components within the Arad, Strata, Petra, and Alta chips that perform the claimed selecting and generating functions:

[

]

(*Id.* at 346:8-348:24.).

To prove infringement of a means-plus-function limitation, the relevant structure in the accused device must be shown to be identical or equivalent to the corresponding structure in the specification. *MobileMedia*, 780 F.3d at 1170. Although Dr. Almeroth provided testimony during the hearing that [] in the Accused ACL Products perform the recited “selecting” and “generating” functions (Tr. at 344:21-350:10), as Staff’s initial post-hearing brief noted, Dr. Almeroth did not even attempt to provide an analysis that [] in the Accused ACL Products have identical or equivalent structure as the priority encoder disclosed in the specification. (*See id.* 350:8-10; SBr.II at 34.). Cisco therefore failed to meet its burden of showing by a preponderance of the evidence that the Accused ACL Products include this limitation of claim 1 of the ’577 patent.

f) “means for making a routing decision in response to said access result”

As discussed above in Section V.B.8, Cisco’s and Staff’s proposed corresponding structures for this limitation were rejected, and the correct corresponding structure was found to be “the access control element.” Therefore, even if Cisco sufficiently showed that the Accused ACL Products include Cisco’s and Staff’s proposed structures, Cisco failed to meet its burden of showing by a preponderance of the evidence that the Accused ACL Products include a structure

that is identical or equivalent to the access control element disclosed in the specification of the '577 patent.

6. Claim 63 of the '853 Patent.

Instead of providing additional analysis to support his infringement opinions with regard to claim 63 of the '853 patent, Cisco's expert, Dr. Almeroth, simply referred to the same evidence he relied upon for his infringement opinion with regard to claim 1 of the '577 patent. (Tr. (Almeroth) at 356:18-366:1.). However, as discussed above in Section I.C.2.b.ii, this decision grants Arista's motion to strike Cisco's expert Dr. Almeroth's hearing testimony that links his infringement opinion about claim 63 of the '853 patent with the evidence adduced for claim 1 of the '577 patent for the reasons specified in the referenced section. Moreover, Arista's expert, Dr. Olivier, testified during the hearing that the evidence adduced to show infringement of claim 1 of the '577 patent is not sufficient to show infringement of claim 63 of the '853 patent due to the differences in the claim language. (Tr. (Olivier) at 2797:22-2798:10.). Staff agrees with Dr. Olivier that the proof of infringement of claim 1 of the '577 patent does not prove infringement of claim 63 of the '853 patent. (SBr.II at 38-39; SRBr.II at 27-28.). Since Dr. Almeroth's testimony has been stricken, Dr. Olivier's testimony that infringement of claim 63 has not been shown stands un rebutted. Therefore, Cisco failed to prove by preponderance of evidence that the Accused ACL Product infringe claim 63.

7. Direct Infringement by Arista

Cisco's expert, Dr. Almeroth, testified during the hearing that Arista directly infringes by importing into the United States the Accused ACL Products,⁶⁸ based on Arista's interrogatory

⁶⁸ See *supra* Section V.C.1.

answers. (Tr. (Almeroth) at 373:24-374:7 (citing CX-0732C at 14; CX-0585C at 26)).

However, at the time of importation, the Accused ACL Products are not loaded with the EOS software, which includes the accused features necessary for infringement. (Tr. (Metivier) at 2068:1–2073:15.). Arista therefore contends that it does not infringe by importing the Accused ACL Products. (RBr.II at 28 (citing *Certain Elec. Devices with Image Processing Sys., Components Thereof, & Associated Software*, Inv. No. 337-TA-724, 2012 WL 3246515 (USITC Dec. 21, 2011) (Comm’n Op.)); RBr.II at 20.).

In *Electronic Devices*, complainants S3 Graphics Co. Ltd. and S3 Graphics Inc. (collectively, “S3G”) filed a complaint alleging that respondent Apple Inc. (“Apple”) violated Section 337 by importing infringing devices. 2012 WL 3246515, at *1. However, at the time of importation, Apple’s devices did not include encoded images, which are required to infringe the asserted claims. *Id.* at *8. The image data was created by Apple in a format that infringes the claims only after importation when Apple tested the devices. *Id.* at *9. The Commission turned to the statutory language which defines unlawful “[t]he importation into the United States” “of articles that . . . infringe a valid and enforceable United States patent.” *Id.* at *8 (quoting 19 U.S.C. § 1337(a)(1)(B)). The Commission interpreted the statute as requiring that the status of the articles must be infringing at the time of importation to find a Section 337 violation. *Id.* at *9. Accordingly, Apple’s devices that lack the image data when imported did not violate Section 337. *Id.* at *11.

Here, the Accused ACL Products lack the infringing EOS software at the time of importation. (Tr. (Metivier) at 2068:1–2073:15.). Instead, the EOS software is loaded onto the Accused ACL Products in the United States after importation. (*Id.*). Therefore, there cannot be

Public Version

a Section 337 violation based solely on Arista's importation of the Accused ACL Products that lack the EOS software. *See Elec. Devices*, 2012 WL 3246515, at *9.

Additionally, Mr. Hua Zhong⁶⁹ testified during his deposition on July 17, 2015, and Dr. Holbrook (Arista VP of Software Engineering) testified during the hearing that [

] (JX-0045C at 9:10-10:7, 75:12-25; Tr. (Holbrook) at 1812:23–1813:16.). Arista and Staff contend that a Section 337 violation cannot be based on Arista's use of a patented method. (RBr.II at 28 (citing *Elec. Devices*, 2012 WL 3246515); SRBr.II at 29 (citing *Elec. Devices*, 2012 WL 3246515, at *9; *Suprema, Inc. v. Int'l Trade Comm'n*, 796 F.3d 1338, 1352-53 (Fed. Cir. 2015) (en banc)).).

As discussed above, in *Electronic Devices*, even though Apple's devices were not infringing at the time of importation, Apple conducted tests in the United States after importation, and Apple's testing constituted use that infringed the asserted claims. 2012 WL 3246515, at *8-9. Nonetheless, the Commission rejected S3G's assertion that Apple direct infringement through its own testing can form the basis of a Section 337 violation. *Id.* at *12. Instead, the Commission held that proof of indirect infringement is required to find a violation of a method claim. *Id.* at *12 ("We analyze a violation of section 337(a)(1)(B)(i) based on method claim 16 under the statutory rubrics of indirect infringement."); *id.* at *13 ("[W]e determine that Apple's domestic use of imported devices to practice the method steps in claim 16 of the '146 patent will not support a determination of violation of section 337(a)(1)(B)(i) without evidence of indirect infringement.").

⁶⁹ At the time of his testimony, Mr. Hua Zhong ("Mr. Zhong") was a software manager at Arista. (JX-0045C at 9:21-22.).

Public Version

In *Suprema, Inc. v. International Trade Commission*, Cross Match Technologies, Inc. filed a complaint with the Commission, alleging infringement of patents involving fingerprint scanning technology. 796 F.3d at 1341. Respondent Suprema, Inc. (“Suprema”) is a Korean company that makes fingerprint scanning devices, and respondent Mentalix, Inc. (“Mentalix”) is an American company that makes software to operate Suprema’s scanners. *Id.* at 1341-42. Because Suprema’s scanners infringe certain method claims when used with Mentalix’s software, the Commission found that Mentalix directly infringes the claim and Suprema induces infringement by Mentalix, and issued a limited exclusion order barring the importation of Suprema’s scanners. *Id.* at 1342-44. On appeal by Suprema and Mentalix, a divided panel of the Federal Circuit concluded that the Commission lacked authority to issue an exclusion order predicated on induced infringement because such imports are not in an infringing state at the time of importation. *Id.* at 1344. However, the Federal Circuit en banc gave *Chevron* deference to the Commission’s interpretation of Section 337 and held that “the phrase ‘articles that infringe’ covers goods that were used by an importer to directly infringe post-importation as a result of the seller’s inducement.” *Id.* at 1352-53. Contrary to Cisco’s interpretation of *Suprema, Inc. v. International Trade Commission*, nothing in that opinion supports Cisco’s position that proof of direct infringement of a method claim post-importation alone is sufficient to find a Section 337 violation. (*See* CRBr.II at 25.). The Federal Circuit upheld the Commission’s exclusion order barring importation of Suprema’s scanners, because the Commission found that Suprema had induced Mentalix’s direct infringement. *Suprema*, 796 F.3d at 1342-44.

Here, even if Arista directly infringes the ’577 patent by using the Accused ACL Products through its testing of the products in the United States after importation, Arista’s direct

infringement alone without proof of indirect infringement cannot form the basis of Section 337 violation. *See Elec. Devices*, 2012 WL 3246515, at *12-13. Therefore, Arista's alleged direct infringement of the '577 patent is not relevant.

8. Indirect Infringement

As discussed below, evidence establishes that Arista indirectly infringes the '577 patent⁷⁰ both by inducing and contributing to the direct infringement by its customers.

a) Direct Infringement by Arista's Customers

Mr. Anshul Sadana,⁷¹ Arista's Vice President of Customer Engineering, testified during his deposition on May 22, 2015, that [] (JX-0037C at 126:4–127:13.).

Moreover, in arguing that Arista's switches have substantial non-infringing uses [] Arista's expert, Dr. Olivier testified during the hearing that [] (Tr. (Olivier) at 2833:11-21.). *See Lucent Techs.*, 580 F.3d at 1317 (“[A] finding of infringement can rest on as little as one instance of the claimed method being performed during the pertinent time period.”). Cisco's expert, Dr. Almeroth testified during the hearing

⁷⁰ Since the Accused ACL Products do not directly infringe the '853 patent, there cannot be indirect infringement of the '853 patent. *See In re Bill of Lading Transmission & Processing Sys. Pat. Litig.*, 681 F.3d 1323, 1333 (Fed. Cir. 2012).

⁷¹ At the time of his testimony, Mr. Anshul Sadana (“Mr. Sadana”) was Arista's Vice President of Customer Engineering. (JX-0037C at 32:11-15.). Arista designated Mr. Sadana as a fact witness to provide testimony regarding: (1) Arista and its history, success, investments, customers, and market share; (2) the market for the accused products and features; (3) the use or lack thereof of accused features by Arista's customers; (4) the lack of suitable replacements for the accused Arista products; (4) any Arista interactions with Cisco; and (5) the timing of Arista's knowledge of the asserted patents. (RPSt. at 3.).

⁷² Mr. Sadana did not specifically name the “other customers” besides []

that, based on Arista's interrogatory answers, [

] (*Id.* at 384:7-21.). Therefore, the weight of the testimonial evidence supports a legal finding that Arista's customers directly infringe the '577 patent.

b) Induced Infringement

Arista admitted in an interrogatory answer that it had requisite knowledge of the '577 patent since December 4, 2014. (CX-0727C at 48.). Moreover, Cisco's expert, Dr. Almeroth, testified during the hearing that Arista provides a 2200-page "User Manual" to its customers and that the manual contains specific instructions on how to use the Accused ACL Products in an infringing manner. (Tr. (Almeroth) at 379:2-19 (discussing CX-0221 at 838-39, 842).). The User Manual includes instructions on how to create, maintain, and modify ACLs. (*Id.*).

Additionally, Mr. Bechtolsheim, a co-inventor of the '577 patent, testified during his deposition on May 29, 2015, that [

⁷³ [

]

Public Version

] Therefore, the evidence shows that Arista had specific intent to encourage its customers to infringe the '577 patent.

Arista's initial post-hearing brief presents a legal argument that Arista's non-infringement defenses negate any requisite intent. (RBr.II at 27.). It is true that Arista's belief that it does not infringe could be evidence of lack of specific intent. *See DSU Med. Corp. v. JMS Co.*, 471 F.3d 1293, 1307 (Fed. Cir. 2006) (upholding jury's verdict of no induced infringement based on evidence that the defendant believed that its product does not infringe). However, the evidence here shows that Arista knew that its products infringed certain of Cisco's assigned patents and that it knowingly encourages and assists its customers to infringe. *See Commil*, 720 F.3d at 1367.

Specifically, Arista's only non-infringement argument is that its products do not practice the "in parallel" limitation of claim 1 of the '577 patent. (*See supra* Section V.C.). Mr. Bechtolsheim testified during his deposition on May 29, 2015, [

] supports a finding that Arista did not have and could not have a good-faith belief that it did not infringe the '577 patent.

For these reasons, Cisco has proven by a preponderance of the evidence that Arista induces infringement of the '577 patent.

c) Contributory Infringement

As noted above in Section V.C.7 with respect to direct infringement, the Accused ACL Products are not loaded with the infringing EOS software at the time of importation. (Tr.

Public Version

(Metivier) at 2068:1–2073:15.). Arista refers to its switch products without software as “Blank Switches.” (RBr.II at 28.). Arista also imports the hardware components (e.g., chassis, printed circuit boards, power supply, CPU card, and fan module) of the Accused ACL Products separately for later assembly in the United States. (Tr. at 1455:16–1458:3, 1653:15–1654:5, 1986:6–1987:4.). Arista refers to these hardware components as “Imported Components.” (RBr.II at 28.).

Cisco’s expert, Dr. Almeroth, [] (Tr. (Almeroth) at 380:4-20.). He specifically noted that the title of the ’577 patent is “access control list processing in *hardware*” and [] (*Id.* (emphasis added)). Dr. Almeroth also opined during the hearing, based on testimony of various Arista witnesses, that there is no substantial non-infringing use for the Blank Switches. (*Id.* at 380:21-381:24.). Mr. Kenneth Duda,⁷⁴ the CTO and Senior VP at Arista, testified during his deposition on May 20, 2015, that [] (JX-25C at 204:23-205:8.). Mr. Metivier, Vice President of Manufacturing and Platform Engineering at Arista, testified during his deposition on May 28, 2015, that [] (JX-0033C at 98:1-8.). Mr. Anshul Sadana, an Arista Senior VP, testified during his deposition on May 22, 2015, that []

⁷⁴ At the time of his testimony, Mr. Kenneth Duda (“Mr. Duda”) was the Chief Technology Officer and Senior Vice President of Software Engineering of Arista. (JX-0025C at 38:23-25.). Arista designated Mr. Duda as a fact witness to provide testimony regarding: (1) Arista and its history; (2) Arista’s entry into the market; (3) the design, development, and operation of the accused products, including Arista’s EOS system and its features; (4) any Arista interactions with Cisco; (5) Arista’s lack of knowledge of the asserted patents; and (5) the fact that the accused software and features are not imported into the U.S. (RPSt. at 2.).

Public Version

] (JX-0037C at 119:22–120:5).

Arista's expert, Dr. Olivier, testified during the hearing that the Blank Switches and the Imported Components [

] (Tr. (Olivier) at 2836:1-8.). He opined that [

] (*Id.* at 2836:9-14.). He also testified that the Imported Components [

] (*Id.* at 2836:18–2837:9.).

However, there is no evidence that the Blank Switches and the Imported Components [] (See Tr. (Almeroth) at 1097:22–1098:8.). Mr. Sadana testified during the hearing [

] (Tr. (Sadana) at 2133:23–2134:5.). During his hearing testimony, Mr. Metivier corroborated Mr. Sadana's testimony that [

] (Tr. (Metivier) at 2079:17–2081:4.).

Dr. Olivier presented additional arguments with respect to substantial non-infringing uses. He testified during the hearing that the [

⁷⁵ See *infra* note 97.

]

(RBr.II at 26-27.). However, as Cisco argued, and as this decision finds, Arista and Dr. Olivier improperly focused on the non-accused features of the Accused ACL Products. (CRBr.II at 27 (citing *Fujitsu Ltd. v. Netgear Inc.*, 620 F.3d 1321, 1330-31 (Fed. Cir. 2010))).

In *Fujitsu Ltd. v. Netgear Inc.*, Philips Corporation accused Netgear Inc. of infringing a patent directed to transmitting data by fragmenting messages into segments of a predetermined length. 620 F.3d at 1326. With regard to the issue of substantial non-infringing uses, Netgear argued that more than 40% of its accused products have settings that result in no fragmentation and thus represent substantial non-infringing uses. *Id.* at 1330. Philips responded by citing *i4i Ltd. v. Microsoft Corp.*, 598 F.3d 831, 849 (Fed.Cir.2010), and arguing that “in determining whether there are substantial noninfringing uses, we must only consider the ‘particular tool’ in question when that tool is ‘a separate and distinct feature’ of a larger product.” *Id.* The Federal Circuit agreed with Philips that “the component at issue here is the specific hardware and software that performs fragmentation” and the fact that “a user can turn off the infringing features” does not establish substantial non-infringing uses. *Id.* at 1330-31. The Federal Circuit noted, “it is undisputed that, when [the fragmentation feature is] activated, the product is infringing,” and therefore held that “the fragmentation software does not have substantial noninfringing uses.” *Id.* at 1330-31.

In *i4i.Ltd. v. Microsoft Corp.*, i4i Limited Partnership sued Microsoft Corporation, alleging that certain versions of Microsoft’s word-processing software, Microsoft Word,

Public Version

included an infringing custom XML editor. 598 F.3d at 839. Microsoft argued that the district court erred by instructing the jury to focus on the custom XML editor feature of Microsoft Word, rather than all of Microsoft Word, when deciding whether any non-infringing uses were substantial. *Id.* at 849. The Federal Circuit rejected Microsoft's argument because Microsoft's ability to include or exclude the custom XML editor feature from various versions of Microsoft Word showed that the custom XML editor is a "separate and distinct" feature, and therefore the jury justifiably concluded that the relevant material for the contributory infringement analysis was the custom XML editor, not all of Microsoft Word. *Id.*

[

] *See Fujitsu*, 620 F.3d at 1330; *i4i*, 598 F.3d at 849. [

] *See Fujitsu*, 620 F.3d at 1330-31; *i4i*, 598 F.3d at 849. It has been determined above in Section V.C that the Accused ACL Products, [

] infringe the '577 patent. Arista has not adduced any evidence of substantial non-infringing uses of []

Therefore, Cisco has proven by a preponderance of the evidence that Arista contributorily infringes the '577 patent.

D. Technical Prong of Domestic Industry⁷⁶

⁷⁶ Cisco asserts that it satisfies the technical prong of the domestic industry requirement based on its practice of the Asserted Patents. (Compl. at ¶¶ 31-32.).

Public Version

As discussed below, all of Cisco's asserted domestic industry (DI) products practice claims 1-2, 7, 9-10, and 15 of the '577 patent and claim 63 of the '853 patent.

1. Legal Framework of the Technical Prong

A complainant in a patent-based Section 337 investigation must demonstrate that it is practicing or exploiting the patents at issue. *See* 19 U.S.C. § 1337(a)(2) and (3); *Certain Microsphere Adhesives, Process for Making Same, and Prods. Containing Same, Including Self-Stick Repositionable Notes*, Inv. No. 337-TA-366, Comm'n Op. at 8, Pub. No. 2949 (U.S.I.T.C., Jan. 16, 1996) ("*Microsphere Adhesives*"). The technical prong of the domestic industry requirement is satisfied when the complainant establishes that it is practicing or exploiting the patents at issue. *See id.*

The test for claim coverage for the purposes of the technical prong of the domestic industry requirement is the same as that for infringement. *Certain Doxorubicin and Preparations Containing Same*, Inv. No. 337-TA-300, Initial Determination at 109, 1990 WL 710463 (U.S.I.T.C., May 21, 1990), *aff'd*, Views of the Commission at 22 (October 31, 1990). "First, the claims of the patent are construed. Second, the complainant's article or process is examined to determine whether it falls within the scope of the claims." *Id.* The technical prong of the domestic industry can be satisfied either literally or under the doctrine of equivalents. *Certain Dynamic Sequential Gradient Devices and Component Parts Thereof*, Inv. No. 337-TA-335, Initial Determination at 44, Pub. No. 2575 (U.S.I.T.C., Nov. 1992).

"In order to satisfy the technical prong of the domestic industry requirement, it is sufficient to show that the domestic industry practices any claim of that patent, not necessarily an asserted claim of that patent." *Certain Ammonium Octamolybdate Isomers*, Inv. No. 337-TA-477, Comm'n Op. at 55 (U.S.I.T.C., Jan. 5, 2004) ("*Certain Isomers*"). Fulfillment of the

Public Version

“technical prong” of the domestic industry requirement is not determined by a rigid formula but rather by the articles of commerce and the realities of the marketplace. Certain Diltiazem Hydrochloride and Diltiazem Preparations, Inv. No. 337-TA-349, Initial Determination at 139, USITC Pub. No. 2902 (June 1995) (unreviewed in relevant part); Certain Double-Sided Floppy Disk Drives and Components Thereof, Inv. No. 337-TA-215, Views of the Comm’n, Additional Views of Chairwoman Stern on Domestic Industry and Injury at 22, 25, USITC Pub. No. 1860 (May 1986).

2. Cisco’s DI Products

Cisco’s expert, Dr. Almeroth testified during the hearing that Cisco’s Catalyst 6500 and Nexus 3000, 5000, 6000, 7000, and 9000 products (“ACL DI Products”) practice claims 1, 2, 7, 9-10, and 15 of the ’577 patent and claims 46 and 63 of the ’853 patent based on his review of “mountains of documents” and “source code.” (Tr. (Almeroth) at 222:8–223:21, 395:8-23). Arista did not dispute that Cisco’s Catalyst 6500 and Nexus 3000, 5000, 6000, and 7000 products practice the referenced claims. Arista’s expert, Dr. Olivier, did not testify during the hearing about these products. (RBr.II at 30; Tr. (Olivier) at 2802:20–2803:4.).

With regard to Nexus 9000, Dr. Olivier testified that it uses the Strata chip and therefore does not practice the “in parallel” requirement of the claims for the same reasons he provided with respect to his non-infringement opinions of Strata-based Arista switches. (Tr. (Olivier) at 2803:1-4.). For reasons explained below, Nexus 9000 practices the referenced claims.

3. Claim 1 of the ’577 Patent

The only ACL DI Product with a Strata chip is Nexus 9000. (See Tr. (Olivier) at 2803:1-4; CBr.II at 37; SBr.II at 42.). Dr. Olivier provide in this opinion that the Nexus 9000 does not practice the “in parallel” limitation of the claim for the same reasons he disputed the

infringement of Arista's products that include a Strat chip. (Tr. (Olivier) at 2803:1-4.). As determined above with respect to the infringement analysis, the Strata chip practices the "in parallel" limitation of claim 1. (*See supra* Section V.C.2.a.). Therefore, Cisco has proven by a preponderance of the evidence that all of the ACL DI Products, including Nexus 9000, practice claim 1 of the '577 patent.

4. Claims 2, 7, 9-10, and 15 of the '577 Patent

There is no dispute among the parties that Cisco's ACL DI Products practice the additional limitations of dependent claims 2, 7, 9-10, and 15 of the '577 patent. (*See* RBr.II at 20, 30.). Therefore, Cisco has proven by a preponderance of un rebutted evidence that the ACL DI Products practice claims 2, 7, 9-10, and 15 of the '577 patent. Cisco has not met its burden of proof.

5. Claim 46 of the '853 Patent.

As explained below, the preponderance of the evidence does not establish that Cisco's ACL DI Products practice claim 46 of the '853 patent.

a) "means for maintaining a set of access control patterns in at least one associative memory"

There is no dispute that Cisco has proven that the ACL DI Products meet this limitation. (*See id.* at 21, 23, 30.).

b) "means for receiving a packet label responsive to a packet, said packet label being sufficient to perform access control processing for said packet"

There is no dispute that Cisco has proven that the ACL DI Products meet this limitation. (*See id.*).

c) "means for matching matchable information, said match able information being responsive to said packet label, with said set of access control patterns in parallel"

Public Version

Consistent with Cisco's and Staff's proposals to construe the corresponding structure of this limitation as the access control memory and the content-address memory units, respectively, Cisco's expert, Dr. Almeroth, testified during the hearing that each of the ACL DI Products includes TCAMs. (Tr. (Almeroth) at 403:7–406:12.). However, both Cisco's and Staff's proposals have been rejected above in Section V.B.5. The correct corresponding structure for this limitation has been determined to be the access control element. (Section V.B.5.). Therefore, even if the evidence sufficiently shows that the ACL DI Products include TCAMs, consistent with Cisco's and Staff's proposed constructions, Cisco failed to meet its burden of showing by a preponderance that the ACL DI Products include a structure that is identical or equivalent to the access control element disclosed in the specification. *See MobileMedia*, 780 F.3d at 1170 (“Literal infringement of a § 112 ¶ 6 limitation requires that the relevant structure in the accused device perform the identical function recited in the claim and be identical or equivalent to the corresponding structure in the specification.”).

d) “means for generating a set of matches in response thereto, each said match having priority information associated therewith”

Consistent with Cisco's and Staff's proposals to construe the corresponding structure of this limitation as the access control memory and the content-address memory units, respectively, Cisco's expert, Dr. Almeroth, testified during the hearing that each of the ACL DI Products includes TCAMs. (Tr. (Almeroth) at 406:17–407:8.). However, both Cisco's and Staff's proposals have been rejected above in Section V.B.6. The correct corresponding structure for this limitation has been determined to be the access control element. (Section V.B.6.). Therefore, even if the evidence sufficiently shows that the ACL DI Products include TCAMs, consistent with Cisco's and Staff's proposed constructions, Cisco failed to meet its burden of

showing that the ACL DI Products include a structure that is identical or equivalent to the access control element disclosed in the specification. *See MobileMedia*, 780 F.3d at 1170 (“Literal infringement of a § 112 ¶ 6 limitation requires that the relevant structure in the accused device perform the identical function recited in the claim and be identical or equivalent to the corresponding structure in the specification.”).

- e) **“means for selecting at least one of said matches in response to said priority information, and generating an access result in response to said at least one selected match”**

There is no dispute among the parties that Cisco has proven by a preponderance of evidence that non-Strata-based ACL DI Products, i.e., Catalyst 6500 and Nexus 3000, 5000, 6000, and 7000, meet this limitation. (*See* RBr.II at 30.).

With respect to Nexus 9000, which contains the Strata chip, Cisco’s expert, Dr. Almeroth, testified during the hearing that the priority resolution logic in the Strata chip of Nexus 9000 performs the “selecting” and “generating” functions of this limitation. (Tr. (Almeroth) at 409:20-24.). However, he provided no opinion that the priority resolution logic in Nexus 9000 is the same or equivalent to the priority encoder of the ’853 patent, which is the corresponding structure of this limitation. (*See id.*; *see also supra* Section V.B.7.). Because Cisco has not proven by a preponderance of the evidence that the priority resolution logic in the Strata chip is the same or equivalent to the priority engine of the patent, Cisco has failed to meet its burden of showing by a preponderance of the evidence that Nexus 9000, which include a Strat chip, satisfies this limitation. *See MobileMedia*, 780 F.3d at 1170 (“Literal infringement of a § 112 ¶ 6 limitation requires that the relevant structure in the accused device perform the identical function recited in the claim and be identical or equivalent to the corresponding structure in the specification.”).

f) “means for making a routing decision in response to said access result”

As discussed above in the claim construction section, Cisco proposed that the corresponding structure for this limitation is “(1) output port (Fig. 2, 202) and priority encoder (Fig. 2, 220) and/or (2) a general-purpose processor, program and data memory, and mass storage (JX-0003 at Fig. 1 (‘CPU’), 5:21-25), executing operating system software (*id.* at 5:21-25; 1:33-38) performing at least the step of comparing a packet to administrative policies or restrictions (*id.* at 5:25-30).” Staff proposed that the corresponding structure is “a priority encoder of the type set forth in Fig. 2 (element 220) and described in col. 5:1-20.” (*See supra* Section V.B.8.). However, for reasons explained above in Section V.B.8, both Cisco’s and Staff’s proposals have been rejected, and it has been determined that the correct corresponding structure is the access control element. (*Id.*).

Cisco’s expert, Dr. Almeroth, testified during the hearing that each of the ACL DI Products includes certain structures consistent with Cisco’s and Staff’s proposals that have been rejected as reliable claim constructions. (Tr. (Almeroth) at 411:14-413:8; *see supra* Section V.B.8.). Therefore, even if the evidence sufficiently proves that the ACL DI Products include structures consistent with Cisco’s and Staff’s constructions that were rejected in the *Markman* Order, Cisco did not offer independent evidence. Cisco, therefore, failed to meet its burden to prove by a preponderance of the evidence that the ACL DI Products include a structure that is identical or equivalent to the access control element disclosed in the specification. *See MobileMedia*, 780 F.3d at 1170 (“Literal infringement of a § 112 ¶ 6 limitation requires that the relevant structure in the accused device perform the identical function recited in the claim and be identical or equivalent to the corresponding structure in the specification.”).

6. Claim 63 of the '853 Patent.

Arista did not dispute that Cisco has proven by a preponderance of the evidence that non-Strata-based ACL DI Products, i.e., Catalyst 6500 and Nexus 3000, 5000, 6000, and 7000, meet this limitation. (*See* RBr.II at 30.).

With regard to Nexus 9000, the only dispute center on Dr. Olivier's opinion that the Strata chip does not practice the "in parallel" requirement for the same reasons it presented with respect to its non-infringement arguments. (*See* Tr. (Olivier) at 2803:1-4.). Dr. Olivier's opinion has been rejected because the Strata chip meets the "in parallel" limitation. (*See supra* Section V.C.2.a.). Therefore, Cisco has proven by a preponderance of the evidence that the ACL DI Products, including Nexus 9000, practice this claim.

E. Validity

As discussed below, claims 1, 7, 9-10, and 15 of the '577 patent and claim 46 of the '853 patent are invalid but Arista is estopped from asserting invalidity defenses.

1. Assignor Estoppel

Assignor estoppel "is an equitable remedy that prohibits an assignor of a patent, or one in privity with an assignor, from attacking the validity of that patent when he is sued for infringement by the assignee." *MAG Aerospace Indus., Inc. v. B/E Aerospace, Inc.*, 816 F.3d 1374, 1379-80 (Fed. Cir. 2016) (citing *Diamond Sci. Co. v. Ambico, Inc.*, 848 F.2d 1220, 1224 (Fed. Cir. 1988)). (*See* Section IV.D.). The evidence demonstrates that: (1) Mr. Bechtolshiem and Dr. Cheriton, the named inventors of the '577 and '853 patents, validly assigned their rights in these patents to Cisco; and (2) Mr. Bechtolshiem and Dr. Cheriton are both in privity with Arista. Accordingly, assignor estoppel applies to the '577 and '853 patents. Moreover, Arista's arguments against the application of assignor estoppel fail for the reasons discussed below.

a) Assignment of the '577 and '853 Patents to Cisco

The evidence adduced in this Investigation established that Mr. Bechtolshiem and Dr. Cheriton validly assigned the '577 and '853 patents to Cisco. (CX-0788 at CSI-ANI-00106666.000045.). Both Mr. Bechtolshiem and Dr. Cheriton joined Cisco in September 1996 after selling Granite Systems, a company they co-founded in 1995, to Cisco for approximately \$220 million. (JX-0021C at 13:7-18, 17:1-2, 18:5-7, 20:23-25, 22:12-14; JX-0023C at 13:12-14, 13:20-22, 15:18-22; CX-0780C; CX-0784C.). Mr. Bechtolshiem and Dr. Cheriton were employed by Cisco until December 2003. (JX-0021 at 23:19-20; JX-0023C at 21:5-10; CX-0783C.).

When Mr. Bechtolshiem joined Cisco in 1996, he was initially the Vice President (“VP”) of Engineering for the Gigabit Switching Business Unit (“GSBU”); he was later promoted to General Manager (“GM”) of the GSBU. (JX-0021C at 22:25–23:5.). As VP of Engineering and GM for the GSBU from 1996 to 2003, Mr. Bechtolshiem worked on the Cisco Catalyst 4000 and 4500⁷⁷ products. (*Id.* at 23:10-16, 23:24–24:3.). While Dr. Cheriton was at Cisco, he served as Technical Advisor and acting Chief ASIC Architect for the Cisco Catalyst 4X00 line. (JX-0023C at 34:18–35:2.). For their work, Mr. Bechtolshiem and Dr. Cheriton received salaries as well as additional income in the form of stock options and bonuses for certain issued patents. (*See, e.g.,* JX-0021C at 156:20–157:2, 156:7-13, 154:7-11; JX-0023C at 21:11-13, 22:25–24:3, 31:10-15; CX-0785C; CX-0786C.).

The evidence reflects that Mr. Bechtolshiem and Dr. Cheriton validly assigned the '577 and '853 patents for consideration while they were employed at Cisco. (CX-0788 at CSI-ANI-

⁷⁷ Cisco relies, *inter alia*, on the 4500 series of Cisco Catalyst switches for purposes of establishing the technical prong of the DI requirement for the '875 and '492 patents. (CBr. at 7.).

Public Version

00106666.000045.). The assignment for U.S. Application Serial No. 09/108,071 (“’071 application”), from which the ’577 patent issued and of which the ’853 is a continuation application, expressly states that “for valuable consideration, the receipt of which is hereby acknowledged,” Mr. Bechtolshiem and Dr. Cheriton “sell, assign, transfer and set over” to Cisco Technology, Inc. “the full and exclusive right, title and interest in” the ’071 application, and “in and to any and all letters patent to be granted and issued therefor.” (*Id.*; JX-0015 at 3.). The assignment of the ’577 and ’853 patents was recorded with the PTO. (JX-0017 at 3; JX-0015 at 2.). In addition, Mr. Bechtolshiem and Dr. Cheriton signed inventor’s declarations in connection with the patent applications that eventually issued as the ’577 and ’853 patents. Their declarations stated their belief that, *inter alia*, they were the first, joint inventors, the claimed subject matter was novel, and the specification of each application adequately describes how to make and use the claimed invention. (JX-0009 at 59-60; JX-0011 at 43-46.).

In 2014, Cisco Technology, Inc. transferred title of the ’577 and ’853 patents to Cisco Systems, Inc., the complainant in this Investigation. (JX-0015 at 7-29; JX-0017 at 6-28.). In December 2003, Mr. Bechtolshiem and Dr. Cheriton left Cisco, and in October 2004, formed Arista Network, Inc., the respondent in this Investigation. (*See, e.g.*, JX-0021C at 36:1-4, 23:19-23; JX-20:4-15, 21:5-10, 38:25–39:4.).

b) Privity Between Mr. Bechtolshiem and Dr. Cheriton, and Arista

The evidence adduced in this Investigation establishes that Mr. Bechtolshiem and Dr. Cheriton are in privity with Arista. To begin with, Mr. Bechtolshiem and Dr. Cheriton co-founded Arista. (*See, e.g.*, JX-0021C at 35:10–36:13, 36:25–37:2, 37:6-8; JX-0023C at 37:7-9.). In defining parties in privity, the Federal Circuit has identified corporations founded by an

Public Version

assignor as one such example. *Diamond Sci. Co. v. Ambico, Inc.*, 848 F.2d 1220, 1224 (Fed. Cir. 1988); *see also Juniper Networks, Inc. v. Palo Alto Networks, Inc.*, 15 F. Supp. 3d 499, 508 (D. Del. 2014) (finding founder status as “dispositive” of privity).

In addition to being co-founders of Arista, Mr. Bechtolshiem and Dr. Cheriton are substantial holders of Arista stock and, thus, have considerable control over Arista’s operations. (See, e.g., JX-0021C at 80:18-25 [

] *See, e.g., Mentor Graphics Corp. v. Quickturn Design Sys., Inc.*, 150 F.3d 1374, 1379 (Fed. Cir. 1998) (in affirming the lower court’s ruling that privity existed between Mentor and Meta, the Federal Circuit noted that “[o]wnership of Meta stock, in and of itself, gives Mentor considerable control over that Meta’s operations” and that “[e]ven a party that owns less than a majority of a company’s stock can still exercise effective control over the company’s operations”).

Additionally, Mr. Bechtolshiem and Dr. Cheriton have held, and Mr. Bechtolshiem continues to hold, high-ranking positions at Arista that entail significant decision-making responsibilities and control over Arista’s product development, such as recruiting high-level engineers including Mr. Holbrook and Mr. Duda. (See, e.g., JX-0026C at 84:14-19; JX-0021C at 50:3-8, 60:14-19, 252:21-23; JX-0023 at 101:14-16.). Since Arista was formed in October 2004, Mr. Bechtolshiem has been a director of Arista. (JX-0021C at 36:5-7, 45:11–46:25.). In 2008, he became the Chairman of the Board and Arista’s Chief Development Officer. (*Id.*). See, e.g., *Shamrock Technologies*, 903 F.2d at 794 (privity found between a company and assignor who

Public Version

was both one of its corporate vice presidents and a shareholder). As Chief Development Officer, Mr. Bechtolshiem is responsible for the overall product development and technical direction of Arista's hardware. (JX-0021C at 47:4-7.). Dr. Cheriton was a member of the Board of Directors and served as Arista's Chief Scientist from October 2004 to March 1, 2014. (JX-0023C at 46:3-8, 73:14-17.).

Arista contends that it is not in privity with Mr. Bechtolshiem and Dr. Cheriton because Mr. Bechtolshiem and Dr. Cheriton did not design the accused chips or the accused Arista software. (RBr.II at 38.). However, Arista failed to cite to case law that supports its contention. Courts have found privity where the assignor did not assist at all in developing the accused product. *Mentor Graphics*, 150 F.3d at 1379; *see also Synopsys, Inc. v. Magma Design Automation, Inc.*, 2005 WL 1562779, at *6 (N.D. Cal. July 1, 2005) (noting that the Federal Circuit "has not required that the assignor be personally involved in designing the allegedly infringing aspects of a product before finding the doctrine of assignor estoppel applicable"); *CA, Inc. v. New Relic, Inc.*, 2015 WL 1611993, at *9 (E.D.N.Y. Apr. 8, 2015) ("Privity does not require that the assignor directly design the infringing features of the accused product.").

The weight of the evidence establishes that as Chief Development Officer and Chief Scientist, Mr. Bechtolshiem and Dr. Cheriton, respectively, significantly guided the development of Arista's infringing products. For example, within a year of founding Arista, [] (JX-0021C at 56:1-12, 57:24-58:7, 61:12-17; JX-0023C at 157:14-158:7.). Since 2006, Mr. Bechtolshiem has held weekly meetings with senior design teams to discuss design goals and architecture of Arista's products. (JX-0021C at 53:15-54:18, 56:13-15.). Dr. Cheriton also attended weekly meetings with senior engineers, such as Mr. Duda and Mr. Holbrook, to discuss software

Public Version

architecture issues, which often included discussion of Arista's EOS software. (JX-0023C at 76:16–77:17; 78:25–80:13.).

Additionally, Mr. Bechtolshiem and Dr. Cheriton have had significant involvement with the development of the accused products. Both Mr. Bechtolsheim and Dr. Cheriton were

[] (JX-0021C at 63:4-14; 67:3–71: 8, 77:5-12; 131:10–135:5, 247:22–248:2, 248:5-8, 248:20-21, 248:24-25, 249:2-4; JX-0023C at 94:24–95:16, 96:17–98:20; 99:16–100:2; JX-0025C at 64:6–65:10; CX-0818C at 336-38; CX-0934C; CX-0819C at 846-51; CX-0277C; CX-0933C at 441-43.). [

] (JX-0025C at 147:10–148:2; CX-0069C at 973-74; CX-0791 at 732.). In addition, Dr. Cheriton provided technical input to the engineers [] (JX-0023C at 82:6-9.).

Based on the preponderance of the evidence, Mr. Bechtolshiem and Dr. Cheriton are far more than just “mere employee[s]” of Arista. *Shamrock Techs.*, 903 F.2d at 794. Arista clearly availed itself of Mr. Bechtolshiem's and Dr. Cheriton's “knowledge and assistance” to conduct engineering research, and develop products that directly infringe Cisco's asserted patents. *Id.* (citing *Mellor v. Carroll*, 141 F. 992, 993-94 (C.C.D. Mass. 1905)). Accordingly, Arista is in privity with Mr. Bechtolshiem and Dr. Cheriton for purposes of the assignor estoppel analysis and the finding of this Initial Determination.

2. Assignor Estoppel Applies to Arista's Defenses Based on 35 U.S.C. § 112 ¶ 2

Arista contends that assignor estoppel does not apply to a defense of indefiniteness. (RBr.II at 39.). Without any legal support, Arista stated in its initial Post-Hearing Brief that it “is

Public Version

unaware of any reported case in which assignor estoppel barred a definiteness challenge.” (*Id.*).

Assignor estoppel is an equitable doctrine that prevents an assignee from later challenging the validity of the assigned patent or patent application. *See, e.g., Diamond Scientific*, 848 F.2d at 1224; *see also Westinghouse Elec. & Mfg. Co. v. Formica Insulation Co.*, 266 U.S. 342, 349 (1924) (stating that “an assignor of a patent right is estopped to attack the utility, novelty or **validity** of a patented invention which he has assigned or granted as against any one claiming the right under his assignment or grant”) (emphasis added). Asserting that certain claims are invalid as indefinite is an attack of the validity of those claims. *See, e.g., Biosig Instruments, Inc. v. Nautilus, Inc.*, 783 F.3d 1374, 1377 (Fed. Cir. 2015) (“A claim is invalid for indefiniteness if its language, when read in light of the specification and the prosecution history, fails to inform, with reasonable certainty, those skilled in the art about the scope of the invention.”) (internal citation omitted). Thus, the doctrine of assignor estoppel applies to claims of indefiniteness, and applies here.

Citing to *Westinghouse Electric & Manufacturing Co. v. Formica Insulation Co.* and *Diamond Scientific*, Arista argued that because assignor estoppel does not bar claim interpretation, it should not bar indefiniteness for the same reasons. *Westinghouse Elec. & Mfg. Co. v. Formica Insulation Co.*, 266 U.S. 342, 351 (1924); *Diamond Sci.*, 848 F.2d at 1226. The Supreme Court in *Westinghouse* deviated from earlier Federal Circuit Court cases that excluded any consideration of evidence where the assignor tried to narrow or qualify the construction of the asserted claims in light of the prior art. *Westinghouse*, 266 U.S. at 350. In *Westinghouse*, the Court held that the “better rule” was to allow such consideration. *Id.* “Otherwise[,] the most satisfactory means of measuring the extent of the grant the government intended and which the

Public Version

assignor assigned would be denied to the court in reaching a just conclusion. *Id.* at 350-51. The Court specifically distinguished such instances from claims of validity. *Id.* at 351.

Of course, the state of the art cannot be used to destroy the patent and defeat the grant, because the assignor is estopped to do this. But the state of the art may be used to construe and narrow the claims of the patent, conceding their validity. The distinction may be a nice one but seems to be workable.

Id.

Diamond Scientific does not support Arista's argument either. In that case, the Federal Circuit recognized that *Westinghouse* allows for an accommodation when the rights of patent are assigned before the patent is granted. *Diamond Sci.*, 848 F.2d at 1266. The Federal Circuit opined that:

To the extent that *Diamond* may have broadened the claims in the patent applications (after the assignments) beyond what could be validly claimed in light of the prior art, *Westinghouse* may allow appellants to introduce evidence of prior art to narrow the scope of the claims of the patents, which may bring their accused devices outside the scope of the claims of the patents in suit. This *exception* to assignor estoppel also shows that estopping appellants from raising invalidity defenses does not necessarily prevent them from successfully defending against *Diamond's* infringement claims.

Id. (emphasis added).

Neither case supports Arista's contention that the exception to the assignor estoppel doctrine for claim construction issues should include challenges to the definiteness of an asserted claim. Moreover, validity issues including indefiniteness and ambiguity are resolved independent of claim construction. *Liebel-Flarsheim Co. v. Medrad, Inc.*, 358 F.3d 898, 903 (Fed. Cir. 2004).

For these reasons, the application of assignor estoppel in this Investigation applies to Arista's indefiniteness defense. *See Intel*, 946 F.2d at 837 (the Federal Circuit has held that "both statutory and case law required that assignor estoppel be considered and applied in section

337 cases,” and instructed that “the Commission’s public interest responsibilities do not give it an independent duty to determine the validity of a patent where no party made such a challenge”) (citing *Lannon Mfg. Co. v. Int’l Trade Comm’n*, 799 F.2d 1572, 1579 (Fed. Cir. 1986)).

Although the doctrine of assignor estoppel bars Arista’s invalidity defenses against the ’577 and ’853 patents, Arista’s remaining invalidity arguments with regard to anticipation and obviousness will be addressed in the sections below.

3. Anticipation

a) Anticipation by Feldmeier

U.S. Patent No. 5,920,886 (“Feldmeier”) is titled “Accelerated Hierarchical Address Filtering and Translation Using Binary and Ternary CAMs.” (RX-0743 at [54]). Feldmeier discloses improved uses of binary or ternary content-addressable memories (CAMs) for performing hierarchical address translation that requires a lower number of searches of the CAMs compared to prior techniques. (*Id.* at 5:32-35.). Feldmeier was filed on March 14, 1997, and issued on July 6, 1999. (*Id.* at [22], [45]). Since Feldmeier predates Cisco’s alleged invention date of September 1997 for the ’577 and ’853 patents, Feldmeier is prior art under 35 U.S.C. § 102(e). (Tr. (Olivier) at 2806:23–2807:2; RBr.II at 30.). As explained below, Feldmeier anticipates claims 1, 7, 9-10, and 15 of the ’577 patent and claim 46 of the ’853 patent.

i. Claim 1 of the ’577 patent

Arista’s expert, Dr. Olivier, testified during the hearing that Feldmeier teaches every limitation of claim 1 of the ’577 patent. (Tr. (Olivier) at 2806:19-2814:24.). The only dispute raised by Cisco’s expert, Dr. Almeroth, relates to whether Feldmeier teaches the claimed “access control.” (Tr. (Almeroth) at 2968:11-2974:15.). To resolve this dispute, it is important to note

Public Version

that the parties agreed that the term “access control” has a plain and ordinary meaning and that the term “access control patterns” has been construed to mean “patterns of bits or other elements used for access control.” (*Markman* Order at 12; *see supra* Section V.B.1.).

Dr. Olivier offered his opinion that Feldmeier’s disclosure of a firewall in connection with Figure 14 teaches the claimed “access control.” (Tr. (Olivier) at 2808:13-18.). Feldmeier discloses:

FIG. 14 illustrates a network firewall device according to one embodiment of the invention. Network firewalls are circuits used to allow data packets to be transmitted only to certain destination and *to discard packets* being transmitted to other destinations.

(RX-743 at 13:7-11 (emphasis added).).

In reference to Figure 14, Feldmeier discloses that a packet is received and routed to a demultiplexer **1430**, an address is extracted from the packet and matched with contents of a network address lookup **1440**, and depending on a signal output from the network address lookup **1440**, the demultiplexer **1430** routes the packet either to an output packet queue **1450**, which leads to a network **1470**, or to a discard line **1460**. (*Id.* at 13:12-30.). These disclosures of permitting or denying transmission of packets satisfy the “access control” element of claim 1. (Tr. (Olivier) at 2808:13-18.).

Moreover, Dr. Olivier relied upon the disclosures of access control in “Fast Routing Table Lookup Using CAMs” by Anthony J. McAuley and Paul Francis (INFOCOM Proceedings 1993) (“McAuley”), which is incorporated by reference in Feldmeier. (*Id.* at 2808:20-21, 2811:19–2812:5.).

Whether material is incorporated by reference into a host document is a question of law. A patent claim is invalid due to anticipation if, within the four corners of a single, prior art document . . . every element of the claimed invention [is described] However, [m]aterial not explicitly contained in the single, prior

Public Version

art document may still be considered for purposes of anticipation if that material is incorporated by reference into the document.

To incorporate matter by reference, a host document must contain language clearly identifying the subject matter which is incorporated and where it is to be found; a mere reference to another application, or patent, or publication is not an incorporation of anything therein. Put differently, the host document must identify with detailed particularity what specific material it incorporates and clearly indicate where that material is found in the various documents.

Callaway Golf Co. v. Acushnet Co., 576 F.3d 1331, 1346 (Fed. Cir. 2009) (citations and quotation marks omitted) (alterations in original). Feldmeier uses the following language to incorporate by reference to McAuley: “Several techniques that utilize content addressable memories (CAMs) for searching a routing table are discussed in ‘Fast Routing Table Lookup Using CAMs’ by Anthony J. McAuley and Paul Francis (1993 INFOCOM Proceedings) [hereinafter ‘the McAuley article’], which is herein incorporated by reference in its entirety.” (RX-743 at 2:64-3:2 (brackets in original)). Therefore, Feldmeier identifies the subject matter being incorporated and the specific article in which the subject matter is found. (*See id.*). Accordingly, Feldmeier properly incorporates by reference McAuley. *See Callaway*, 576 F.3d at 1346.

Cisco argued that Feldmeier did not properly incorporate by reference McAuley because: (1) “Feldmeier does not identify with detailed particularity how and where McAuley discloses packet filtering,” and (2) the purpose of incorporating McAuley in Feldmeier does not match the purpose of using McAuley’s disclosure to show anticipation. (CBr.II at 43.). Additionally, Cisco’s expert, Dr. Olivier, testified during the hearing that McAuley is incorporated into the background sections of Feldmeier rather than the sections discussing Feldmeier’s invention. (Tr. (Olivier) at 2970:20-23.). Cisco presents this fact as a third basis for arguing that Feldmeier’s incorporation of McAuley is legally flawed. However, none of Cisco’s three bases is required by

Public Version

law (*see Callaway*, 576 F.3d at 1346), and Cisco provide no authority for such requirements (*see* CBr.II at 43).

McAuley discloses “filtering,” i.e., a “network address screening function,” in which “a CAM can be loaded with a list of valid/invalid network addresses” such that packets are processed according to the results. (RX-0753 at 1385.). McAuley thus discloses “access control.” (*See* Tr. (Olivier) at 2812:1-5.). Therefore, Feldmeier includes additional disclosures of access control through its incorporation by reference of McAuley.

Cisco’s expert, Dr. Almeroth, testified during the hearing Feldmeier discloses mere packet forwarding, which is “very different” from the claimed access control. (Tr. (Almeroth) at 2969:5-9.). Staff similarly argued that the CAM entries in Feldmeier do not constitute the claimed “access control patterns.” (SBr.II at 48-49.). Staff recognizes that Feldmeier discloses a network firewall that uses patterns to either allow packets to be transmitted to certain destinations or discard packets being transmitted to other destinations, but argued that such patterns are not the claimed “access control pattern,” which are used for “access control” as construed. (*Id.* at 49.). Despite the parties’ agreement that the term “access control” has a plain and ordinary meaning, Dr. Almeroth and Staff did not explain the specific meaning they ascribe to the term “access control” such that Feldmeier’s disclosure of filtering and discarding packets is not a form of “access control.” (*See Markman* Order at 12; Tr. (Almeroth) at 2969:5-9; SBr.II at 48-49.).

Comparing independent claim 1 and dependent claim 15 reveals that “access control” in claim 1 certainly includes and may be even broader than filtering packets such that some are permitted and some are discarded. (*Compare* JX-0005 claim 1 (“making a routing decision in response to said access result”) *with id.* claim 15 (“said routing decision includes permitting or

Public Version

denying access”).).

Additionally, Dr. Almeroth and Staff did not identify anything more that Arista’s Accused ACL Products and Cisco’s ACL DI Products perform to satisfy the “access control” limitation beyond permitting and denying packets. (*See supra* Section V.C, V.D.). Staff also noted that the Patent Trial and Appeal Board (PTAB) declined to institute an *inter partes* review (“IPR”) of the ’577 patent based on Feldmeier. (SRBr.II at 35 (citing *Arista Networks, Inc. v. Cisco Sys., Inc.*, IPR2015-01049, 2015 WL 7303838 (P.T.A.B. Oct. 22, 2015)).). However, the PTAB did not construe “access control.” Like Dr. Almeroth and Staff, the PTAB did not explain why Feldmeier’s disclosure does not satisfy the “access control” limitation. *See Arista*, 2015 WL 7303838.

Dr. Almeroth also testified during the hearing that the firewall embodiment of Feldmeier describes performing only “forwarding.” (Tr. (Almeroth) at 2970:5-15.). Cisco argued that there is no disclosure in Feldmeier of *how* the firewall embodiment is used to perform access control. (CBr.II at 42.). However, as shown above, Feldmeier’s firewall embodiment, at least in column 13 and in reference to Figure 14, discloses a firewall device that permits routing of packets or denies routing by discarding packets in response to matching address extracted from the packet with the contents of the network address lookup. (RX-743 at 13:7-30; Tr. (Olivier) at 2808:13-18.). In fact, Feldmeier’s disclosure is more specific than claim 1. Claim 1 generally requires “access control.” (JX-0005 claim 1.). Claim 1 does not explicitly require any step of permitting or denying access. (*Cf.* JX-0005 claim 15.). Feldmeier specifically discloses steps of permitting packets and denying packets. (RX-743 at 13:7-30.).

Additionally, Dr. Almeroth argued during the hearing that the firewall embodiment of Feldmeier is not performed “in the CAM.” (Tr. (Almeroth) at 2987:21–2988:14.). It is unclear

why Dr. Almeroth believes the firewall embodiment must be performed “in” a CAM to anticipate claim 1. (*See id.* at 2972:4-7 (“[Y]ou still have box 1440 that’s doing the IP address lookup. To the extent there’s a network firewall at all, it would have to be somewhere else.”)). Dr. Almeroth does not identify any claim language that supports such a requirement. (*See id.* at 2987:21–2988:14.). By its language, claim 1 of the ’577 patent does not necessarily require the steps of “generating an access result” and “making a routing decision” to be performed inside a CAM. (*See* JX-0005 claim 1.).

Lastly, Dr. Almeroth’s argument during the hearing that a CAM embodiment disclosed in Feldmeier is incompatible with the firewall embodiment of Feldmeier. (Tr. (Almeroth) at 2971:21-2972:16.). Although Dr. Olivier did not address this issue, Dr. Almeroth’s final argument to avoid invalidation of Cisco’s patent is unavailing.

The specification of Feldmeier is clearly organized into three parts. Feldmeier first describes several prior art implementations of CAM and their shortcomings. (RX-0743 at 1:13–5:27.). Feldmeier then describes several embodiments of improved CAMs in accordance with its inventions. (*Id.* at 7:27–12:44.). Finally, Feldmeier discloses that the improved CAMs can be used in a router, a firewall, or a switch. (*Id.* at 12:49-13:6 (router), 13:7-30 (firewall), 13:31–14:12 (switch).). Dr. Almeroth even admitted that Feldmeier discloses using its inventive CAM in a firewall. (Tr. (Almeroth) at 2985:16-18 (“The fact that you could put the circuitry into a firewall is something that’s basically contemplated in one paragraph in Feldmeier.”)). Dr. Almeroth’s argument that Feldmeier’s CAMs would be incompatible to use in a firewall, which is directly contrary to Feldmeier’s disclosure, is not persuasive. Indeed, Dr. Almeroth and Cisco do not assert that Feldmeier fails to satisfy the enablement requirement under 35 U.S.C. § 112 ¶ 1. *See Impax Labs., Inc. v. Aventis Pharm., Inc.*, 545 F.3d 1312, 1314 (Fed. Cir. 2008) (requiring

an anticipating prior art reference to be enabling).

For these reasons, Arista has proven by clear and convincing evidence, largely because of errors in Cisco's testimony and argument, that Feldmeier anticipates claim 1 of the '577 patent.

ii. Claims 7, 9-10, and 15 of the '577 patent

There is no dispute that Feldmeier teaches the additional limitations of dependent claims 7, 9-10, and 15 of the '577 patent. (CBr.II at 46; SBr.II at 48-49.). Therefore, Feldmeier anticipates claims 7, 9-10, and 15 of the '577 patent.

iii. Claim 46 of the '853 patent

Arista's expert, Dr. Olivier, provided no analysis with respect to claim 46 of the '853 patent but instead opined during the hearing that Feldmeier anticipates this claim based on the analysis he provided with respect to claim 1 of the '577 patent. (Tr. (Olivier) at 2826:25–2827:6.). Arista tried to justify Dr. Olivier's approach by noting that Cisco relied on the same evidence to show infringement of claim 1 of the '577 patent and claim 46 of the '853 patent. (RBr.II at 32-33.). This approach was found to be insufficient by the ALJ above, especially given that claim 46 includes means-plus-function elements. (*See supra* Section V.C.5.). Therefore, Arista failed to meet its burden and provide clear and convincing proof required to show anticipation of claim 46.

b) Anticipation by Hendel

U.S. Patent No. 6,081,522 ("Hendel") is titled "System and Method for a Multi-Layer Network Element." (RX-0745 at [54].). Hendel discloses a multi-layer network element that receives a packet from an input port, examines the packet for multiple types of forwarding information, searches an associative memory for each type of information, and combines the multiple search results to make a decision to forward the packet to one or more output ports. (*Id.*

at abstract, 5:1-37.). Hendel was filed on June 30, 1997, and issued on June 20, 2000. (*Id.* at [22], [45].). Since Hendel predates Cisco's alleged invention date of September 1997 for the '577 and '853 patents, Hendel is prior art under 35 U.S.C. § 102(e). (Tr. (Olivier) at 2816:7-11; RBr.II at 33.). For reasons explained below, Hendel does not anticipate claims 1, 2, 7, 9-10, and 15 of the '577 patent and claims 46 and 63 of the '853 patent.

i. Claims 1, 2, 7, 9-10, and 15 of the '577 patent

Arista's expert, Dr. Olivier, testified during the hearing that Hendel teaches every limitation of claim 1 of the '577 patent. (Tr. (Olivier) at 2816:12–2822:15.). With respect to claim 1, Cisco's expert, Dr. Almeroth, and Staff identify only one claim element that is allegedly missing from Hendel. (Tr. (Almeroth) at 2954:25–2963:10; SBr.II at 47-48.). Dr. Almeroth testified that Hendel's disclosure of discarding packets is different from the claimed "access control," because Hendel does not discard packets in response to an affirmative match as the claims require. (Tr. (Almeroth) at 2956:6-2957:20.). In particular, he argued that Hendel discloses discarding packets due to lack of a match or due to unsupported headers. (*Id.* at 2962:2-6.). Staff agreed with Dr. Almeroth that Hendel's disclosure of the forwarding memory does not teach a decision not to forward a packet as part of access control. (SRBr.II at 34-35.).

Hendel discloses that a forwarding logic **52** determines what to do with the packet, and the forwarding logic **52** passes its determination to the input port **50i**. (RX-745 at 9:22-24.). The forwarding logic would determine either to forward the packet to "one or more output ports" or to "no output ports." (*Id.* at 9:43-44.). In the former scenario, where "the input port **50i** does not filter the packet," the input port **50i** tells the appropriate output ports **56** where the packet is stored. (*Id.* at 9:24, 34-42.). In the latter scenario, where "there is no appropriate destination," i.e., the input port does filter the packet, "the packet is discarded." (*Id.* at 10:51-52.). Therefore,

Hendel discloses filtering and discarding packets.

The question is whether Hendel discloses discarding packets in response to affirmative match. Arista's expert, Dr. Olivier, testified during the hearing that claim 1 of Hendel discloses choosing not to output a packet based on an affirmative match. (Tr. (Olivier) at 2821:17–2822:15.). He offered his opinion that Hendel's process of selecting an output port based on a match could select "no port." (*Id.* at 2821:20-25.). However, his opinion is not supported by any disclosure in Hendel.

Hendel discloses that "[i]f no match is found, then the forwarding logic 52 instructs the input port 50i to flood the packet to all of the active output ports 56." (*Id.* at 11:10-12.). Hendel also discloses that "[t]he output of the class logic 60 identifies . . . what the merge logic should do if there is no match in the forwarding memory 40 for a packet." (*Id.* at 11:61-65.). One of the "four possible outcomes when no match occurs" is to "discard the packet." (*Id.* at 12:1-10.). The merge logic 66 can direct the input port 50i to "filter the packet." (*Id.* at 13:4-6.). "Packets that the merge logic instructs the input port 50i to filter are those that include certain header information determined to be unsupported." (*Id.* at 13:9-11.). If the packet is "ill formed," it is discarded. (*Id.* at 8:39-40.). Accordingly, Hendel discloses that packets may be discarded if there is no match in memory or if it includes unsupported headers. As Dr. Almeroth and Staff contend, Hendel does not disclose determining not to forward a packet in response a match.

Accordingly, Arista has not proven by clear and convincing evidence that Hendel anticipates claim 1 of the '577 patent. Moreover, Hendel does not anticipate claims 2, 7, 9-10, and 15, which depend from claim 1. *See Certain Static Random Access Memories and Prods. Containing Same*, Inv. No. 337-TA-792, 2013 WL 1154018, at *10 (U.S.I.T.C. Feb. 25, 2013) (holding that because the independent claim was not anticipated, claims depending from the

Public Version

independent claim were also not anticipated) (citing *Hartness Int'l, Inc. v. Simplimatic Eng'g Co.*, 819 F.2d 1100, 1108 (Fed. Cir. 1987)).

ii. Claims 46 and 63 of the '853 patent

Arista's expert, Dr. Olivier, provided no analysis with respect to claim 46 of the '853 patent but instead offered his opinion during the hearing that Hendel anticipates this claim based on the analysis he provided with respect to claim 1 of the '577 patent. (Tr. (Olivier) at 2826:25–2827:6.). Arista attempted to justify Dr. Olivier's approach by noting that Cisco relied on the same evidence to show infringement of claim 1 of the '577 patent and claim 46 of the '853 patent. (RBr.II at 35.). This approach has been found to be insufficient in Section V.C.5, especially given that claim 46 includes means-plus-function elements. (*See supra* Section V.C.5.). Arista therefore has failed to meet its burden to provide clear and convincing proof to prove that Hendel anticipates claim 46.

Arista's expert, Dr. Olivier, testified during the hearing that Hendel anticipates claim 63 of the '853 patent. (Tr. (Olivier) at 2824:20–2826:3.). Cisco's expert, Dr. Almeroth, testified for a second time that Hendel does not teach “access control,” as required by claim 63. (Tr. (Almeroth) at 2965:22–2968:10.). Staff agreed with Dr. Almeroth. (SBr.II at 48.). This issue is the same as that the parties disputed with respect to claim 1 of the '577 patent. For the reasons discussed above in Section V.E.3.a.i with respect to claim 1 of the '577 patent, it is the finding of this Initial Determination that Hendel does not anticipate claim 63 of the '853 patent.

4. Obviousness

U.S. Patent No. 5,938,736 (“Muller”) is titled “Search Engine Architecture for a High Performance Multi-layer Switch Element.” (RX-0749 at [54].). Muller was filed on June 30, 1997, and issued on August 17, 1999. (*Id.* at [22], [45].). Therefore, Muller is prior art to the

'577 patent. (RBr.II at 36.). With regard to dependent claim 7 of the '577 patent, Arista's expert, Dr. Olivier, testified during the hearing that the combination of Hendel and Muller renders obvious claim 7 of the '577 patent because Muller discloses a ternary CAM that is missing in Hendel, and it would have been obvious to combine Muller with Hendel. (Tr. (Olivier) at 2822:16–2823:24.). Even if Dr. Olivier's opinions about Muller are correct, i.e., Muller discloses a ternary CAM required by dependent claim 7, Dr. Oliver failed to prove by clear and convincing evidence that Hendel teaches each limitation of independent claim 1, as discussed above in Section V.E.3.b.i. Therefore, Arista has failed to meet its burden and show by clear and convincing evidence that claim 7 is obvious.

VI. The '875 and '492 Patents

A. A Person of Ordinary Skill in the Art

A person of ordinary skill in the art for the '875 and '492 patents has been defined as someone who holds at least a Bachelor of Science degree in electrical engineering, computer engineering, or computer science, or an equivalent degree, and approximately two years of related experience in the field of network devices. (*Markman* Order at 36.). Additional formal education in a relevant field, such as work toward a master's degree, would have reduced the amount of industry experience one of skill would have needed in the art. (*Id.*).

B. Disputed Terms

1. '492 Patent, Claims 3-4; '875 Patent, Claims 2-4—“*loop inconsistent port state*”/“*loop inconsistent spanning tree port state*”⁷⁸

Cisco's Proposed Construction	Arista's Proposed Construction	Staff's Proposed Construction
-------------------------------	--------------------------------	-------------------------------

⁷⁸ Joint Claim Construction Report at Attach. A, p. 8.

Public Version

a [port] state in a spanning tree protocol or algorithm in which the port is precluded from forwarding or receiving network messages, such as data packets or frames, and which is entered into in response to the receipt of BPDU messages being stopped	a port state in a spanning tree algorithm, different from the port states defined in the IEEE 802.1D-1998 ⁷⁹ and/or IEEE 802.1w-2001 ⁸⁰ standards, in which the port is precluded from forwarding or receiving network messages (excluding BPDU messages) and which is entered into in response to the receipt of BPDU messages being stopped	a port state in a spanning tree algorithm, different from the port states defined in the IEEE 802.1D-1998 and/or IEEE 802.1w-2001 standards, in which the port is precluded from forwarding or receiving network messages and which is entered into in response to the receipt of BPDU messages being stopped
---	---	---

The claim term “loop inconsistent spanning tree port state” is recited in claims 2-4 of the ’875 patent. (JX-0004 at 13:27-42.). The claim term “loop inconsistent port state” is recited in claims 3 and 4 of the ’492 patent. (JX-0006 at 13:31-39.). The parties agree that a “loop inconsistent port state” is a port state in which “the port is precluded from forwarding or receiving network messages” in response to the receipt of BPDU messages being stopped, as

⁷⁹ “The Institute of Electrical and Electronics Engineers (IEEE) has promulgated a standard (the 802.1D standard) that defines a spanning tree protocol to be executed by 802.1D compatible devices. In general, by executing the 802.1D spanning tree protocol, bridges elect a single bridge within the bridged network to be the ‘root’ bridge.” (JX-0004 at 2:1-7.). “To obtain the information necessary to run the spanning tree protocol, bridges exchange special messages called configuration bridge protocol data unit (BPDU) messages.” (*Id.* at 2:25-27.). “In order to adapt the active topology to changes and failures, the root periodically (e.g., every hello time) transmits BPDU messages. The default hello time is two seconds. In response to receiving BPDUs on their root ports, bridges transmit their own BPDUs from their designated ports, if any. Thus, every two seconds BPDUs are propagated throughout the bridged network, confirming the active topology. If a bridge stops receiving BPDU messages on a given port (indicating a possible link or device failure), it will continue to increment a respective message age value until it reaches a maximum age (max age) threshold. The bridge will then age out, i.e., discard, the stored BPDU information and proceed to re-calculate the root, root path cost and root port by transmitting BPDU messages utilizing the next best information it has.” (*Id.* at 2:43-62.).

⁸⁰ “Recently, the IEEE promulgated a new standard (the 802.1w standard) that defines a rapid spanning tree protocol (RSTP) to be executed by otherwise 802.1D compatible devices. The RSTP similarly selects one bridge of a bridged network to be the root bridge and defines an active topology that provides complete connectivity among the LANs while severing any loops. Each individual port of each bridge is assigned a port role according to whether the port is to be part of the active topology. The port roles defined by the 802.1w standard include Root, Designated, Alternate and Backup.” (JX-0004 at 3:28-38.). “Like the STP described in the 802.1D specification standard, bridges running the RSTP also exchange BPDU messages in order to determine which roles to assign to the bridge’s ports. The BPDU messages are also utilized in the handshake employed to rapidly transition designated ports to the forwarding state.” (*Id.* at 3:66-4:4.).

Public Version

provided in the specification of the '875 and '492 patents. (JX-0004 at 5:31-33; JX-0006 at 35-36.). The parties disagree, however, as to whether the “loop inconsistent port state” should be “different from the port states” defined in the IEEE 802.1D-1998 and/or IEEE 802.1w-2001 standards. (CBr. at 89; RBr. at 99-100; SBr. at 62.).

Arista and Staff propose that the terms be construed to mean “a port state” that is “different from the port states defined in the IEEE 802.1D-1998 and/or IEEE 802.1w-2001 standards” because the specification of the '875 and '492 patents describe the claimed “port state” as a “new state.” (RBr. at 99-100; SBr. at 62; JX-0004 at 5:25-31; JX-0006 at 5:29-35.). This is consistent with other statements in the specification of the '875 and '492 patents distinguishing the “loop inconsistent port state” from the port states defined in the IEEE 802.1D-1998 and/or IEEE 802.1w-2001 standard protocols. For example, the '875 and '492 patent specifications disclose that “[o]nce released from the loop inconsistent state, the port transition state machine 214 preferably transitions port P0 to one of the *conventional* spanning tree port states, e.g., discarding, listening, learning, forwarding, etc. as indicated at block 320.” (JX-0004 at 8:64–9:1 (emphasis added); JX-0006 at 8:61-65 (emphasis added)). That the “loop inconsistent port state” is different from the “conventional” port states defined in the IEEE 802.1D-1998 and/or IEEE 802.1w-2001 standard protocols supports Arista’s and Staff’s proposed construction.

Arista’s and Staff’s proposed construction is supported by testimony from Cisco’s expert, Dr. Stephen Wicker,⁸¹ and Arista’s expert, Dr. Mir. For instance, Dr. Wicker testified to the following:

⁸¹ At the time of his testimony, Dr. Stephen Wicker (“Dr. Wicker”) was a Professor at Cornell University, School of Engineering. (CPSt. at Ex. A.). Cisco retained Dr. Wicker as an expert to provide testimony regarding claim construction, technical background, infringement, and validity of the '492 and '875 patents. (*Id.* at 1.).

Public Version

Q: . . . Are you saying that there's nothing called the loop-inconsistent state in any of the existing spanning tree standards?

A: That's correct. This is -- this is the novel element of the patents in suit, and you won't find them in the actual standards.

(Tr. (Wicker) at 798:19–799:4; *see also* Tr. (Mir) at 1981:17–1982:2 (stating that based, *inter alia*, on the disclosure in the '492 patent (5:33-36, 8:35-65), the “loop inconsistent state” is defined as a “new state”).).

Cisco's proposed construction fails to account for this explicit distinction. Cisco contends that including this additional limitation is contrary to the statements in the '875 and '492 patent specifications that the claimed invention “may be used with *any* spanning tree protocol or algorithm.” (CBr. at 89 (emphasis in original) (citing JX-0006 at 10:15-50)). Cisco is mistaken.

The intrinsic record is clear, and thus it is unnecessary to resort to extrinsic evidence. *Phillips*, 415 F.3d at 1324. Based on the intrinsic evidence, the terms “loop inconsistent port state”/“loop inconsistent spanning tree port state,” as used in the '875 and '492 patents, mean “a port state in a spanning tree algorithm, different from the port states defined in the IEEE 802.1D-1998 and/or IEEE 802.1w-2001 standards, in which the port is precluded from forwarding or receiving network messages and which is entered into in response to the receipt of BPDU messages being stopped.” A general statement that the claimed invention could be used in conjunction with other protocols like those defined in the IEEE 802.1D-1998 and/or IEEE 802.1w-2001 standards has no bearing on the meaning of this particular port state.

C. Accused Loop Guard Products

Cisco has accused Arista's networking switches 7010, 7048, 7050, 7050X, 7150, 7250X, 7280E, 7300, 7300X, and 7500E (“Accused Loop Guard Products”) of directly and indirectly

infringing claims 1-4 and 10 of the '875 patent and claims 1, 3, and 4 of the '492 patent. (*See* CBr. at Attach. D.). Dr. Holbrook, one of Arista's engineers, testified that there are four separate hardware architectures that comprise Arista's networking switches: Strata, Arad, Petra, and Alta. (Tr. (Holbrook) at 1799:6–1800:7.). According to Arista, each switch series uses the "Extensible Operating System" ("EOS"). (Tr. (Metivier) at 2048:9-12.). The EOS software runs several types of spanning tree protocols, including Rapid Spanning Tree Protocol ("RSTP"), Multiple Spanning Tree Protocol ("MSTP"), and Rapid Per-VLAN Spanning Tree ("Rapid PVST"), all of which rely on, and are compliant with, the IEEE 802.1w Rapid Spanning Tree Protocol standard. (Tr. (Wicker) at 777:21–778:16, 788:21–789:4, 801:1-6, 801:19-22, 874:10-12; CX-0602C at 54, 953; JX-0047C at 71:24–72:5; CX-0015 at 7; CX-0017 at 6; Tr. (Mir) at 2006:6-24.).

D. Infringement

1. Direct Infringement of the '875 Patent

Cisco has accused the Accused Loop Guard Products of directly infringing claims 1-4 and 10 of the '875 patent. (*See* CBr. at Attach. D.). As discussed in more detail below, on a claim-by-claim basis, the record evidence fails to show by a preponderance of the evidence that the Accused Loop Guard Products directly infringe the asserted claims of the '875 patent.

None of the Accused Loop Guard Products infringe independent claims 1 and 10 because they do not satisfy the "transition at least one of the device's ports among a plurality of spanning tree port states, including a discarding state, a listening state and a forwarding state" limitation. (JX-0004 at 13:12-14, 14:8-11.). Therefore, none of the Accused Loop Guard Products infringes dependent claims 2, 3, and 4, all of which ultimately depend from claim 1, for the same reason. *See, e.g., Muniauction*, 532 F.3d at 1328-29 n.5 ("A conclusion of noninfringement as to the independent claims requires a conclusion of noninfringement as to the dependent claims.").

a) **Claim 1.**

- i. ***“In an intermediate network device having a plurality of ports for forwarding network messages within a bridged network, a method for preventing the formation of loops within the bridged network, the method comprising the steps of”***

With regard to the preamble above, Cisco claimed, and Arista did not dispute, that the Accused Loop Guard Products meet the preamble of claim 1 of the '875 patent. (CBr. at 91; RBr. at 100-05.). Cisco's expert, Dr. Wicker, testified that each Accused Loop Guard Product is an intermediate network device configured to receive and forward network messages. (See RX-0360C at ¶ 185; Tr. (Wicker) at 806:20–807:7.). He also testified that based, *inter alia*, on Arista's technical documents discussing the Accused Loop Guard Products (*see, e.g.*, CX-0006; CX-0007), the intermediate network device in each of the Accused Loop Guard Products has a plurality of ports to connect the intermediate network device to one or more other devices. (See RX-0360C at ¶ 185; Tr. (Wicker) 806:20–809:16, 811:8-21; *see also, e.g.*, CX-0006 (Arista 7010 has 48 ports); CX-0007 (Arista 7048 has 48 ports); CX-0008 (Arista 7050 and 7050X can have 52 or 64 ports); CX-0010 (Arista 7048); CX-0013 (Arista 7250X has 64 ports); CX-0014 (Arista 7280E has 48 ports); CX-0017 (Arista 7500E can have 288 or 1,152 ports).). Accordingly, because there is no dispute, Cisco has met its burden of proof and demonstrated by a preponderance of the evidence that the preamble of claim of the '875 patent is met by the Accused Loop Guard Products.

- ii. ***“executing a spanning tree protocol (STP) at the intermediate network device so as to elect a root of the bridged network and to transition at least one of the device's ports among a plurality of spanning tree port states, including a discarding state, a listening state and a forwarding state”***

Cisco has failed to meet its burden and prove by a preponderance of the evidence that the

Public Version

Accused Loop Guard Products meet this limitation. This limitation requires a spanning tree protocol that “transition[s] at least one of the device’s ports among a plurality of spanning tree port states, including a discarding state, a listening state and a forwarding state.” (JX-0004 at 13:10-15.). As shown in Section II.B of Appendix A below, “discarding state” has been construed to mean “a port state in a spanning tree protocol or algorithm in which data frames are neither forwarded to nor received from the port.” (*Markman* Order at 42.). The term “listening state” has been construed to mean “a port state in a spanning tree protocol or algorithm in which a port waits for information to determine whether to return to the blocking state or to transition to a state in which location information corresponding to received frames is stored.” (*Id.* at 46.). As discussed below, the evidence shows that the Accused Loop Guard Products do not include a “discarding state” and “listening state” under the adopted constructions of these terms, and that the Accused Loop Guard Products do not “transition” from or to the claimed ports.

With regard to the “discarding state” recited in this limitation, Arista’s expert presented evidence that [] (Tr. (Mir) at 1979:4–1980:15; RDX-4024.). Dr. Mir, [

] (Tr. (Mir) at 1980:10-13.). [

]

Public Version

(RDX-4024.). The same interpretation as Dr. Mir provided is supported by the testimony of Cisco's expert, Dr. Wicker:

[

]

(Tr. (Wicker) at 853:10-14, 855:4-6.). [

] which is incompatible with the Court's construction of "discarding state," the Accused Loop Guard Products do not include the claimed "discarding state."

With regard to the "listening state" recited in this limitation, the weight of the evidence demonstrates that the Accused Loop Guard Products have the same three port states set forth in the 802.1w standard, that is, port states that are discarding, learning and forwarding. Mr. Adam Sweeney,⁸² Arista's VP of software engineering, and Arista's expert, Dr. Mir, both testified that the Accused Loop Guard Products do not include a "listening" port state. (Tr. (Sweeney) at 2325:15-18; Tr. (Wicker) at 851:4-852:1, 867:15-869:10; RX-0879 at 30; Tr. (Mir) at 1970:21-1971:10; RDX-4008.).

Dr. Wicker testified at his deposition that in the Accused Loop Guard Products, the

⁸² At the time of his testimony, Mr. Adam Sweeney ("Mr. Sweeney") was Vice President of Software Engineering at Arista. (JX-0039C at 13:8-10.). Arista designated Mr. Sweeney as a fact witness to provide testimony regarding the design, development, and operation of the accused products, including but not limited to features such as access control lists, loop guard, and/or multi-chassis link aggregation. (RPSt. at 3.).

Public Version

listening port state is not a separate port state, but rather, a functionality present within the discarding port state. (Tr. (Wicker) at 851:20-24 [

] Mr. Sweeney, the Arista employee who wrote the code for Arista’s spanning tree protocols, also testified that [] (Tr. (Sweeney) at 2324:5-12, 2324:25–2325:6.). Therefore, he, too, corroborated Dr. Wicker’s testimony and Arista’s position that there is no “listening” port state in Arista’s Accused Loop Guard Products.

In addition, evidence does not support Cisco’s contention that the “discarding state” of the 802.1w standard, when in the designated or root port roles, corresponds to the “listening state.” (RX-0360C at ¶¶ 38-49, 104; Tr. (Wicker) at 785:14–786:13.). At the hearing, Dr. Wicker relied on Figure 17-17 below, which is taken from a technical document discussing the IEEE 802.1w-2001 standard, in support of his testimony that the port role in the standard corresponds to the claimed “listening” state.

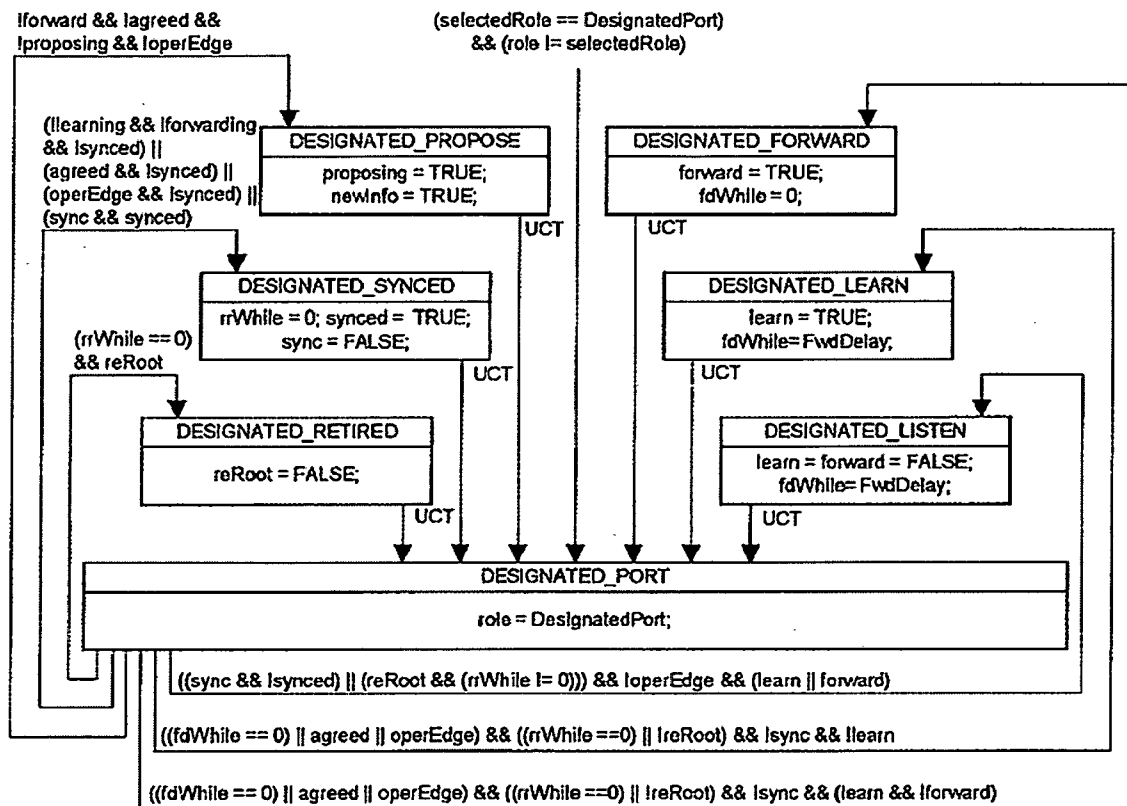

All transitions, except UCT, are qualified by "&& selected && lupdInfo".

Figure 17-17—Port role transitions state machine—Part 3: Designated port role

(CX-0635 at 63, Figure 17-17; *see also* Tr. (Wicker) at 897:1–898:13.). However, as the title of Figure 17-17 indicates, the information contained in Figure 17-17 relate to transitions among “port roles”⁸³ and not “port states.” (*Id.*). The ’875 and ’492 patents, as well as the 802.1w standard, make a clear distinction between these concepts.

⁸³ The ’875 discloses that “[t]he RSTP . . . selects one bridge of a bridged network to be the root bridge and defines an active topology that provides complete connectivity among the LANs while severing any loops. Each individual port of each bridge is assigned a port role according to whether the port is to be part of the active topology. The port roles defined by the 802.1w standard include Root, Designated, Alternate and Backup. The bridge port offering the best, e.g., lowest cost, path to the root is assigned the Root Port Role. Each bridge port offering an alternative, e.g., higher cost, path to the root is assigned the Alternate Port Role. Each bridge port providing the lowest cost path from a given LAN is assigned the Designated Port Role, while all other ports coupled to the given LAN in loop-back fashion are assigned the Backup Port Role.” (JX-0004 at 3:31-45.).

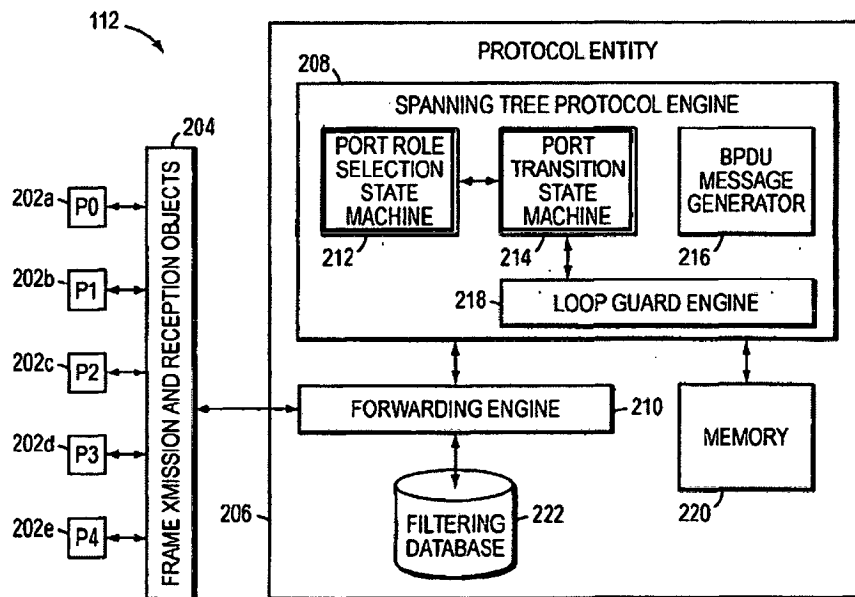

FIG. 2

(JX-0004 at Fig. 2 (showing Port Transition State Machine 214 and Port Role Selection State machine 212); JX-0006 at Fig. 2.). The specifications of the '875 and '492 patents also describe “port states” and “port roles” as separate concepts.

An intermediate network device operating in accordance with the present invention preferably includes a plurality of ports for receiving and forwarding network messages and a spanning tree protocol (STP) engine in communicating relationship with the ports. The STP engine includes a *port transition state machine* for transitioning the ports among a plurality of STP states, such as a *discarding or blocking state*, a learning state and a forwarding state. The STP engine may also include a *port role selection state machine* for assigning STP roles to the ports or for recognizing the association of roles to the ports, including a *Root Port Role*, an *Alternate Port Role*, a *Designated Port Role* and a *Backup Port Role*.

(JX-0004 at 5:17 (emphases added); JX-0006 at 5:8-20 (emphases added); *see also id.* at 9:8-12 (explaining that the spanning tree port states are used by the spanning tree port state transition machine 214), 3:44-45 (noting that the port roles defined by the 802.1w standard are “Root, Designated, Alternate and Backup”).). Additionally, Dr. Wicker testified that a “port role” is

Public Version

different from a “port state,” with which Dr. Mir, Arista’s expert, agreed. (Tr. (Wicker) at 840:16-22, 871:1-3; Tr. (Mir) at 1971:18–1972:11.). Dr. Wicker also acknowledged that the [] (CBr. at 95-96 (citing CPX-0004C), [] (Tr. (Wicker) at 789:5-16.). Thus, this cannot be the claimed “listening” state.

Equally important, based upon Dr. Wicker’s testimony, the Accused Loop Guard Products do not “transition” to a “discarding” port state or “listening” port state, under the Court’s constructions of those terms. As Dr. Wicker testified, the “listening” port of the patent corresponds to the “discarding” state in the Accused Loop Guard Products. (Tr. (Wicker) at 785:14–786:13.). If this is indeed the case, that is, the listening state is present within the “discarding” state in the Accused Loop Guard Products, then as Dr. Mir, Arista’s expert, has testified, there is no “transition” from one port state to another because it is already in the discarding state. (Tr. (Mir) at 1977:20–1979:1; RDX-4019–4021.).

Accordingly, the Accused Loop Guard Products do not meet limitation ii of claim 1 of the ’875 patent.

iii. “periodically receiving configuration bridge protocol data unit (BPDU) messages at one or more of the device’s ports”

Cisco claimed, and Arista did not dispute, that the Accused Loop Guard Products meet this limitation. Cisco’s expert, Dr. Wicker, testified that BPDU messages are received periodically from neighboring switches as part of the operation of RSTP, MST, or Rapid PVST on the Accused Loop Guard Products. (See Tr. (Wicker) at 746:16–747:1, 810:23–811:4; CX-0635; CPX-0004C; JX-0047C at 52:25–53:10, 53:12-15.). Because there is no dispute, Cisco has met its burden and demonstrated by a preponderance of the evidence that the Accused Loop

Guard Products meet limitation iii of claim 1 of the '875 patent.

- iv. ***“in response to the periodic receipt of BPDUs messages being stopped on a given port, (1) preventing the given port from transitioning to the forwarding spanning tree port state, if the given port is in a spanning tree port state other than the forwarding spanning tree port state, or (2) precluding the given port from forwarding or receiving network messages, if the given port is in the forwarding spanning tree port state”***

Cisco claimed, and Arista did not dispute, that the Accused Loop Guard Products meet this limitation. (CBr. at 100-01; RBr. at 100-05.). Dr. Wicker testified that the loop guard in the Accused Loop Guard Products prevents loop formation by [

] (Tr. (Wicker) at 766:16–767:7, 763:22–764:2, 801:23–804:14, 875:21–878:4.).

Arista’s technical documents confirm Dr. Wicker’s testimony. (CX-0602C at 55, 968 [

];

CX-0646C at 517-20); *see also* Arista’s engineers, Mr. Kyle Anderson⁸⁴ and Mr. Sweeney (JX-0047C 66:18-21, 70:9–71:6, 75:12-19; Tr. (Sweeney) 2327:9–2328:15; JX-0039C 213:10–17, 216:4–21.). Accordingly, because there is no dispute, Cisco has met its burden and proven by a preponderance of the evidence that that the Accused Loop Guard Products meet limitation iv of claim 1 of the '875 patent.

⁸⁴ From around June 2010 to early fall of 2011, Mr. Kyle Anderson (“Mr. Anderson”) interned as a software engineer at Arista. (JX-0047C at 12:14-25, 13:1-14.).

v. Conclusion

Because the Accused Loop Guard Products do not include a “discarding state” and “listening state,” and do not “transition” to a “discarding state” or a “listening state,” under the adopted claim constructions, the Accused Loop Guard Products do not infringe claim 1 of the ’875 patent. As Cisco’s own expert, Dr. Wicker, acknowledged in his testimony: (1) [] (Tr. (Wicker) 853:10-14, 855:4-6); (2) [] (Tr. (Wicker) at 851:20-24); and (3) [] (Tr. (Wicker) at 840:16-22, 871:1-3).

b) Claims 2, 3, and 4.

Since claim 1 of the ’875 patent is not infringed because the Accused Loop Guard Products do not include a “discarding state” and “listening state,” and do not transition” to a “discarding state” or a “listening state,” under the adopted constructions, and Cisco’s and Arista’s expert testimonies, and since dependent claims 2, 3, and 4 of the ’875 patent ultimately depend from claim 1, dependent claims 2, 3, and 4 are not infringed. *See Muniauction*, 532 F.3d at 1328-29 n.5 (“A conclusion of noninfringement as to the independent claims requires a conclusion of noninfringement as to the dependent claims.”); *Monsanto*, 503 F.3d at 1359 (“One who does not infringe an independent claim cannot infringe a claim dependent on (and thus containing all the limitations of) that claim.”); *Wahpeton Canvas*, 870 F.2d at 1553 (“It is axiomatic that dependent claims cannot be found infringed unless the claims from which they depend have been found to have been infringed.”).

c) Claim 10.

i. “An intermediate network device configured to receive and

Public Version

forward network messages within a bridged network, the device having a plurality of ports for connecting the device to one or more network entities or other devices, the intermediate network device comprising”

With regard to the preamble of claim 10 above, Cisco claimed, and Arista did not dispute, that the Accused Loop Guard Products meet the preamble. The language of the preamble of claim 10 of the '875 patent is almost identical to the claim language contained in the preamble of claim 1 of the '875 patent. (JX-0004 at 13:5-9, 14:1-5.). Therefore, the interpretation of this language for claim 1 as described in Section VI.D.1.a.i, is the same here. Because there is no dispute, Cisco has met its burden of proof and proven by a preponderance of the evidence that the preamble of claim 10 of the '875 patent is met by the Accused Loop Guard Products.

ii. “a spanning tree protocol (STP) engine configured and arranged to elect a root of the bridged network and to transition at least some of the device’s ports among a plurality of spanning tree port states, including a discarding or blocking state, a listening state and a forwarding state”

The claim language recited in the limitation above is also contained in claim 1 of the '875 patent. (JX-0004 at 13:10-15.). The testimony for the claim language above is exactly the same as is cited in Section VI.D.1.a.ii for claim 1 of the '875 patent. The end result is the same as well.

In summary, Dr. Wicker, Cisco’s expert, agreed with Arista’s expert, Dr. Mir, that the ports in the Accused Loop Guard Products [

] Dr. Wicker acknowledged that a “port role” is different from a “port state,” with which Dr. Mir, Arista’s expert, agreed. (Tr. (Wicker) at 840:16-22, 871:1-3; Tr. (Mir) at 1971:18–1972:11.).

Therefore, just as Cisco failed to meet its burden of proof that the Accused Loop Guard Products meet the almost identical language in claim 1 of the ’875 patent, so too must Cisco fail here. Accordingly, the Accused Loop Guard Products do not meet limitation ii of claim 10 of the ’875 patent.

iii. “a loop guard engine cooperating with the STP engine, wherein configuration bridge protocol data unit (BPDU) messages are periodically received at one or more of the device’s ports”

Cisco has proven by a preponderance of the evidence that the Accused Loop Guard Products meet this limitation. (CBr. at 101-02.). Dr. Wicker testified that [

] (Tr.

(Wicker) at 804:14–805:4; 806:6-19, 789:5-20, 795:7–796:4, 902:2-20; CPX-0004.). Dr. Wicker

also testified that [

] (Tr.

(Wicker) at 806:6-16, 766:16–767:7, 763:22–764:2, 801:23–804:14; CX-0602C at 968.).

Arista maintains that the only evidence of the claimed “loop guard engine” in the Accused Loop Guard Products is one sentence of conclusory testimony by Dr. Wicker that

⁸⁵ “STP” is an acronym for “spanning tree protocol.” (See, e.g., CX-0221 at CSI-ANI-00128383.000045.). Network devices frequently “include redundant communication paths [between network devices] so that a failure of any given link or device does not isolate any portion of the network.” (JX-0004 at 1:10-13, 1:51-53.). However, the redundant paths between network entities can form “highly undesirable” loops along which data may loop indefinitely, thereby preventing data frames from reaching their intended destinations, and may also cause network failures. (*Id.* at 1:50-62.). One approach to reduce the formation of loops was to use spanning tree protocols. (*Id.* at 1:64–2:1.). STPs are link layer network protocols that ensure a loop-free topology for bridged LANs. (See, e.g., CX-0221 at CSI-ANI-00128383.000045.).

Public Version

Arista's loop guard feature is a software module. (RBr. at 105 (citing Tr. (Wicker) at 806:14-16).). However, Dr. Wicker's earlier testimony about the loop guard feature in the Accused Loop Guard Products was based on an Arista user manual (CX-0602C at 968) that supports his testimony. (*See, e.g.*, Tr. (Wicker) at 766:16–767:7.). Arista's argument that Dr. Wicker failed to "opine regarding whether that module functions as required by the claims" is also not supported by the evidence.

During his testimony, Dr. Wicker read verbatim from [

] (Tr. (Wicker) at 766:24–767:4; CX-0602C at 968.).

[

] (*Id.* at 767:5-7.).

Accordingly, the Accused Loop Guard Products meet limitation iii of claim 10 of the '875 patent.

- iv. "in response to the periodic receipt of BPDUs being stopped on a given port, the loop guard engine (1) prevents the given port from transitioning to the forwarding spanning tree port state, if the given port is in a spanning tree port state other than the forwarding spanning tree port state, or (2) precludes the given port from forwarding or receiving network messages"*

Cisco claimed, and Arista did not dispute, that the Accused Loop Guard Products meet this limitation. (CBr. at 100-01; RBr. at 100-05.). This limitation is almost identical to the corresponding limitation in claim 1. (JX-0004 at 13:19-26.). For the reasons discussed in Section VI.D.1.a.iv above with regard to the corresponding limitation in claim 1, the Accused Loop Guard Products meet this limitation. Because there is no dispute, Cisco has met its burden

Public Version

of proof and demonstrated by a preponderance of the evidence that the Accused Loop Guard Products meet limitation iv of claim 1 of the '875 patent.

v. Conclusion

The Accused Loop Guard Products do not infringe claim 10 of the '875 patent because the Accused Loop Guard Products do not include a “discarding state” and “listening state,” and do not “transition” to a “discarding state” or a “listening state,” under the adopted constructions set forth in Section II.B of Appendix A. As Cisco’s own expert, Dr. Wicker, acknowledged in his testimony: (1) [

] (Tr. (Wicker) at 853:10-14, 855:4-6); (2) [

] (Tr. (Wicker) at 851:20-24); and (3) [

] (Tr. (Wicker) at 840:16-22, 871:1-3).

2. Direct Infringement of the '492 Patent

Cisco has accused the Accused Loop Guard Products of directly infringing claims 1, 3, and 4 of the '492 patent. (*See* CBr., Attach. D.). As discussed in more detail below, on a claim-by-claim basis, Cisco has failed to meet its burden and prove by a preponderance of the evidence that the Accused Loop Guard Products directly infringe the asserted claims of the '492 patent.

None of the Accused Loop Guard Products infringes independent claim 1, as both Dr. Mir and Dr. Wicker agreed, because they do not satisfy the “transition at least some of the intermediate network device’s ports among a plurality of port states, including a discarding port state, a listening port state and a forwarding port state” limitation. (JX-0006 at 13:13-16.).

Therefore, none of the Accused Loop Guard Products infringes dependent claims 3, and 4, all of which ultimately depend from claim 1, for the same reason. *See, e.g., Muniauction*, 532 F.3d at

Public Version

1328-29 n.5 (“A conclusion of noninfringement as to the independent claims requires a conclusion of noninfringement as to the dependent claims.”)

a) **Claim 1.**

- i. ***“An intermediate network device configured to receive and forward network messages, the intermediate network device having a plurality of ports to connect the intermediate network device to one or more other devices, the intermediate network device comprising”***

Cisco claimed, and Arista did not dispute, that the Accused Loop Guard Products meet the preamble of the claim 1 of the '492 patent. (CBr. at 102; RBr. at 100-105.). The language of the preamble of claim 1 of the '492 patent is almost identical to the claim language contained in claim 1 of the '875 patent. (JX-0006 at 13:5-9; JX-0004 at 13:5-9.). Therefore, the interpretation of this language for the '492 patent as described in Section VI.D.1.a.i, is the same here. Because there is no dispute, Cisco has met its burden of proof and demonstrated by a preponderance of the evidence that the preamble of claim 1 of the '492 patent is met by the Accused Loop Guard Products.

- ii. ***“one or more processing elements configured to execute a spanning tree protocol engine, the spanning tree protocol engine to implement a Rapid Spanning Tree Protocol (RSTP) to transition at least some of the intermediate network device’s ports among a plurality of port states, including a discarding port state, a listening port state, and a forwarding port state”***

The claim language recited in the limitation above is also contained in claim 1 of the '875 patent. (JX-0004 at 13:10-15.). The testimony for the '492 patent with regard to the claim language above is exactly the same as is cited in Section VI.D.1.a.ii for the '875 patent. The end result is the same as well.

To summarize, Dr. Wicker, Cisco’s expert, agreed with Arista’s expert, Dr. Mir, that the

ports in the Accused Loop Guard Products []

(Tr. (Wicker) at 853:10-14, 855:4-6; Tr. (Mir) at 1980:10-13.). Dr. Wicker also testified that

[

] Dr. Wicker acknowledged

that a “port role” is different from a “port state,” with which Dr. Mir, Arista’s expert, agreed.

(Tr. (Wicker) at 840:16-22, 871:1-3; Tr. (Mir) at 1971:18–1972:11.).

Therefore, just as Cisco has failed to meet its burden of proof that the Accused Loop Guard Products meet the almost identical claim language in claim 1 of the ’875 patent, so too must Cisco fail here. Accordingly, the Accused Loop Guard Products do not meet limitation ii of claim 1 of the ’492 patent.

- iii. ***“the one or more processing elements further configured to execute a loop guard engine, the loop guard engine to cooperate with the spanning tree protocol engine, the loop guard engine configured to, in response to a stoppage of a periodic receipt of bridge protocol data units (BPDUs) on a given port, prevent the given port from transitioning to the forwarding port state, if the given port is in a port state other than the forwarding port state”***

Cisco claimed, and Arista did not dispute, that the Accused Loop Guard Products meet this limitation. (CBr. at 102; RBr. at 100-105.). The claim language recited in the limitation above is also contained in claim 1 of the ’875 patent. (JX-0004 at 13:19-26.). The testimony for the ’492 patent with regard to the claim language above is exactly the same as is cited in Section VI.D.1.a.iv for the ’875 patent. The end result is the same as well.

To summarize, Dr. Wicker testified that the loop guard in the Accused Loop Guard

Products prevents loop formation by []
(Tr. (Wicker) at 766:16–767:7, 763:22–764:2, 801:23–804:14, 875:21–878:4.). This is confirmed by Arista’s technical documents (CX-0602C at 55, 968; CX-0646C at 517-20), and Arista’s engineers, Mr. Anderson and Mr. Sweeney (JX-0047C 66:18-21, 70:9–71:6, 75:12-19; Tr. (Sweeney) 2327:9–2328:15; JX-0039C 213:10–17, 216:4–21.). Because there is no dispute, Cisco has met its burden and demonstrated by a preponderance of the evidence that the Accused Loop Guard Products meet limitation iii of claim 1 of the ’492 patent.

iv. Conclusion

The Accused Loop Guard Products do not infringe claim 1 of the ’492 patent because the Accused Loop Guard Products do not include a “discarding state” and “listening state,” and do not “transition” to a “discarding state” or a “listening state,” under the adopted constructions set forth in Section II.B of Appendix A. Both Cisco’s and Arista’s experts agreed that [

] (Tr. (Wicker) at 851:20-24.). The experts also agree a “port role” is different from a “port state.” (Tr. (Wicker) at 840:16-22, 871:1-3; Tr. (Mir) at 1971:18–1972:11). Therefore, the Accused Loop Guard Products do not infringe claim 1 of the ’492 patent.

b) Claims 3 and 4.

Since claim 1 of the ’492 patent is not infringed because the Accused Loop Guard Products do not include a “discarding state” and “listening state,” and do not transition” to a “discarding state” or a “listening state,” under the adopted constructions, and Cisco’s and Arista’s expert testimonies, and since dependent claims 3 and 4 of the ’492 patent ultimately

Public Version

depend from claim 1, dependent claims 3 and 4 are not infringed. *See Muniauction*, 532 F.3d at 1328-29 n.5 (“A conclusion of noninfringement as to the independent claims requires a conclusion of noninfringement as to the dependent claims.”); *Monsanto*, 503 F.3d at 1359 (“One who does not infringe an independent claim cannot infringe a claim dependent on (and thus containing all the limitations of) that claim.”); *Wahpeton Canvas*, 870 F.2d at 1553 (“It is axiomatic that dependent claims cannot be found infringed unless the claims from which they depend have been found to have been infringed.”).

3. No Direct Infringement of the '875 and '492 Patents in the United States

As noted above in Sections VI.D.1 and VI.D.2, the Accused Loop Guard Products do not directly infringe claims 1-4 and 10 of the '875 patent and claims 1, 3, and 4 of the '492 patent. Independent claims 1 and 10 of the '875 patent and independent claim 1 of the '492 patent contain much of the same claim language. (JX-0004 at 13:10-15, 14:6-11; JX-0006 at 13:10-15.). Because the Accused Loop Guard Products do not include a “discarding state” and “listening state,” and do not transition” to a “discarding state” or a “listening state,” under the adopted constructions, Arista’s customers do not directly infringe the asserted claims of the '875 and '492 patents. (*See, e.g.*, Tr. (Wicker) at 853:10-14, 855:4-6, 851:20-24, 840:16-22, 871:1-3; Tr. (Mir) at 1980:10-13, 1971:18–1972:11.).

4. No Indirect Infringement

Cisco claimed that the Accused Loop Guard Products indirectly infringe claims 1-4 and 10 of the '875 patent and claims 1, 3, and 4 of the '492 patent. (*See* CBr. at Attach. D.). Cisco claimed that Arista both induced its customers to infringe and contributed to the infringement of these asserted claims. (*See* CBr. at 104-05; *see also id.* at Attach. D.).

Public Version

Based, *inter alia*, on Arista's user manuals, internal emails, and testimony from Arista's engineers, as well as Cisco's expert, Dr. Wicker, Cisco contended that Arista knowingly encouraged, instructed, enabled, and thereby induced third parties to infringe the asserted claims of the '875 and '492 patents. (CBr. at 104; Tr. (Wicker) 766:7–767:7; JX-0037C at 146:15–147:8; JX-0032C at 257:9–258:4; JX-0039C at 181:25–182:24, 184:15–23, 185:4–12, 193:5–9; CX-0135C; CX-0157C; CX-0269; CX-0270; CX-0271; CX-0602C; CX-0903; CX-0999.).

Based, *inter alia*, on Arista's user manuals, internal emails, and testimony from Arista's engineers, Cisco also argued that Arista contributorily infringes the asserted claims of the '875 and '492 patents because the switch hardware and components are material parts of the invention with no substantial non-infringing uses that are designed for, and used exclusively with, EOS containing Loop Guard. (CBr. at 105; JX-0037C at 157:7–15, 165:23–166:2; JX-0039C at 197:12–198:3; JX-0047C at 49:8–12, 67:4–8; CX-0157C; CX-0135C; CX-0269; CX-0999; CX-0270; CX-0271.).

Since claims 1–4 and 10 of the '875 patent and claims 1, 3, and 4 of the '492 patent, the Accused Loop Guard Products do not directly infringe any of the asserted claims of these patents because the Accused Loop Guard Products do not include a “discarding state” and “listening state,” and do not transition” to a “discarding state” or a “listening state,” under the adopted constructions, then it follows axiomatically that the Accused Loop Guard Products do not and cannot indirectly infringe after importation either by way of contribution or inducement. *See Limelight Networks, Inc. v. Akamai Techs., Inc.*, 134 S.Ct. 2111, 2117 (2014) (quoting *Afro Mfg. Co. v. Convertible Top Replacement Co.*, 365 U.S. 336, 341 (1961)) (“[L]iability for inducement must be predicated on direct infringement. This is for good reason, as our case law leaves no doubt that inducement liability may arise ‘if, but only if, [there is] . . . direct infringement.’”)

(alteration in original); *Dynacore Holdings Corp. v. U.S. Philips Corp.*, 363 F.3d 1263, 1274 (Fed. Cir. 2004) (noting that in order to prevail under a theory of indirect infringement, plaintiffs must first prove that the defendants' actions led to direct infringement of the asserted patent); *Aro Mfg. Co. v. Convertible Top Replacement Co.*, 365 U.S. 336, 341-42 (1961) (“It is plain that [§] 271(c) . . . made no change in the fundamental precept that there can be no contributory infringement in the absence of a direct infringement.”).

E. Technical Prong⁸⁶

1. Cisco’s DI Products

Cisco identified two series of products as practicing claims 1-4 and 10 of the '875 patent and claims 1, 3, and 4 of the '492 patent. (CBr. at 105.). The Cisco products are: (1) Catalyst 4500 and 6500 Series of products; and (2) Nexus 3000, 4000, 5000, 6000, and 7000 Series of products (collectively, “DI Loop Guard Products”). (*Id.*; Tr. (Wicker) at 817:24–818:3; *see also* Appendix C.). As discussed in more detail below, on a claim-by-claim basis, the preponderance of the evidence does not establish that the DI Loop Guard Products practice the asserted claims of the '875 and '492 patents.

2. '875 Patent

a) Claim 1.

- i. “In an intermediate network device having a plurality of ports for forwarding network messages within a bridged network, a method for preventing the formation of loops within the bridged network, the method comprising the steps of”*

Cisco claimed, and Arista did not dispute, that the DI Loop Guard Products meet the preamble above. (CBr. at 105; RBr. at 110-11.). Dr. Wicker testified that the DI Loop Guard

⁸⁶ For a discussion of the legal framework of the DI technical prong, *see supra* Section V.D.1.

Public Version

Products are intermediate network devices that include a plurality of ports for forwarding network messages within a bridged network. (See, e.g., Tr. (Wicker) at 817:24–820:16; CX-0057C at 1-2 (Cisco Nexus 3064 has 52 ports); CX-0606 at 4 (Cisco Catalyst 4500E has 12 and 48 ports).) The DI Loop Guard Products also perform steps for preventing the formation of loops within the bridged network. (Tr. (Wicker) at 820:17–821:6.). Because there is no dispute, Cisco has met its burden of proof and proven by a preponderance of the evidence that the DI Loop Guard Products meet the preamble of claim 1 of the '875 patent.

- ii. ***“executing a spanning tree protocol (STP) at the intermediate network device so as to elect a root of the bridged network and to transition at least one of the device’s ports among a plurality of spanning tree port states, including a discarding state, a listening state and a forwarding state”***

Cisco has failed to meet its burden to prove by a preponderance of the evidence that the DI Loop Guard Products practice this limitation. The DI Loop Guard Products implement IEEE 802.1w, like the Accused Loop Guard Products. (RX-0360C at ¶ 323.). As discussed in Section VI.D with regard to non-infringement of the Accused Loop Guard Products, the DI Loop Guard Products: (1) do not include a “discarding state” and “listening state,” under the adopted constructions; and (2) do not “transition” to those states.

During the evidentiary hearing, Dr. Wicker acknowledged that in the DI Loop Guard Products, frames are forwarded to ports in the “discarding” port state. (Tr. (Wicker) at 861:24–862:5.). This is inconsistent with the adopted construction of “discarding” port state, which has been construed to mean “a port state in a spanning tree protocol or algorithm in which data frames are neither forwarded to nor received from the port.” (*Markman* Order at 42; see also *infra* App. A Section II.B.).

Public Version

Additionally, Mr. Kaluve, a corporate designee on behalf of Cisco, testified during his deposition on July 28, 2015, that the DI products do not run “legacy” 802.1D STP, the standard that preceded 802.1w and included a separate “listening” port state. (JX-0050C at 123:18-23.). Mr. Kaluve also stated that in the DI Loop Guard Products, the listening state is the same as the blocking state, and that these products do not include a separate listening state. (JX-0050C at 135:9-12, 134:23-25.)

According to Cisco, since the listening state is the same as the blocking state, the DI Loop Guard Products also do not “transition” to a listening port state that can “return” to the blocking state. Accordingly, the DI Loop Guard Products do not practice limitation ii of claim 1 of the ’875 patent.

iii. “periodically receiving configuration bridge protocol data unit (BPDU) messages at one or more of the device’s ports”

Cisco claimed, and Arista did not dispute, that the DI Loop Guard Products meet this limitation. (CBr. at 107-08; RBr. at 110-11.). As Dr. Wicker testified, the DI Loop Guard Products periodically receive BPDUs as part of the normal function of the spanning tree. (*Id.* at 108 (citing Tr. (Wicker) at 746:16–747:1, 823:10-14; CX-0647 at 2; CX-0608 at 98-99; CX-0641 at 25-3).). Because there is no dispute, Cisco has met its burden of proof and proven by a preponderance of the evidence that the DI Loop Guard Products meet limitation iii of claim 1 of the ’875 patent.

iv. “in response to the periodic receipt of BPDU messages being stopped on a given port, (1) preventing the given port from transitioning to the forwarding spanning tree port state, if the given port is in a spanning tree port state other than the forwarding spanning tree port state, or (2) precluding the given port from forwarding or receiving network messages, if the given port is in the forwarding spanning tree port state”

Public Version

Cisco claimed, and Arista did not dispute, that the DI Loop Guard Products meet this limitation. (CBr. at 108; RBr. at 110-11.). Based on Dr. Wicker's testimony and Cisco's technical documents, the Loop Guard feature in the DI products prevents loop formation as a result of unilateral link failures by responding to the periodic receipt of BPDUs stopping, and either: (1) prevents, in that instance, the given port from transitioning to the forwarding spanning tree port state if the port is in a port state other than forwarding; or (2) precludes the given port from forwarding or receiving messages if the given port is in the forwarding spanning tree port state. (Tr. (Wicker) at 820:17–822:14; CX-0340 at 179; CX-0418 at 32-17; CX-0608 at 4, 99; CX-0614 at 10-4; CX-0616 at 106; CX-0620 at 116; CX-0641 at 25-3; CX-0647 at 2.). Because there is no dispute, Cisco has met its burden of proof and demonstrated by a preponderance of the evidence that the DI Loop Guard Products meet limitation iv of claim 1 of the '875 patent.

v. Conclusion

It is a finding of this Initial Determination that the DI Loop Guard Products do not practice claim 1 of the '875 patent because the DI Loop Guard Products do not include a “discarding state” and “listening state,” and do not “transition” to a “discarding state” or a “listening state,” under the adopted constructions. (Tr. (Wicker) at 861:24–862:5; JX-0050C at 123:18-23; CX-0635C at 30; JX-0050C at 135:9-12, 134:23-25.).

b) Claims 2, 3, and 4.

The DI Loop Guard Products do not practice claim 1 of the '875 patent because the DI Loop Guard Products do not include a “listening state,” and do not “transition” to a “discarding state” or a “listening state,” under the adopted constructions. (*See infra* App. A Section II.B.). Since dependent claims 2, 3, and 4 of the '875 patent ultimately depend from claim 1, the DI

Loop Guard Products do not practice dependent claims 2, 3, and 4. *See Alloc*, 342 F.3d at 1375 (“The test for satisfying the ‘technical prong’ of the domestic industry requirement is essentially [the] same as that for infringement, i.e., a comparison of domestic products to the asserted claims.”); *Muniauction*, 532 F.3d at 1328-29 n.5 (“A conclusion of noninfringement as to the independent claims requires a conclusion of noninfringement as to the dependent claims.”); *Monsanto*, 503 F.3d at 1359 (“One who does not infringe an independent claim cannot infringe a claim dependent on (and thus containing all the limitations of) that claim.”); *Wahpeton Canvas*, 870 F.2d at 1553 (“It is axiomatic that dependent claims cannot be found infringed unless the claims from which they depend have been found to have been infringed.”).

c) Claim 10.

- i. “An intermediate network device configured to receive and forward network messages within a bridged network, the device having a plurality of ports for connecting the device to one or more network entities or other devices, the intermediate network device comprising”*

Cisco claimed, and Arista did not dispute, that the DI Loop Guard Products meet the preamble above. (CBr. at 108-09; RBr. at 110-11.). The language of this preamble is almost identical to the language contained in the preamble of claim 1 of the ’875 patent. (JX-0004 at 13:5-9, 14:1-5.). Therefore, the interpretation of this language for claim 10 of the ’875 patent as described in Section VI.E.1.a.i, is the same here. Because there is no dispute, Cisco has met its burden and demonstrated by a preponderance of the evidence that the DI Loop Guard Products meet the preamble of claim 10 of the ’875 patent.

- ii. “a spanning tree protocol (STP) engine configured and arranged to elect a root of the bridged network and to transition at least some of the device’s ports among a plurality of spanning tree port states, including a discarding or blocking state, a listening state and a forwarding state”*

Public Version

Here, Cisco has failed to meet its burden to demonstrate by a preponderance of the evidence that the DI Loop Guard Products practice this limitation of claim 10 of the '492 patent. The claim language recited in the limitation above is also contained in claim 1 of the '875 patent. (JX-0006 at 13:10-16; JX-0004 at 13:10-15.). The testimony for the '492 patent with regard to the claim language above is exactly the same as is cited in Section VI.E.1.a.ii for the '875 patent. The end result is the same as well.

To summarize, Dr. Wicker testified that the DI Loop Guard Products implement IEEE 802.1w, like the Accused Loop Guard Products. (RX-0360C at ¶ 323; *see also* JX-0050C at 123:18-23.). As such, the DI Loop Guard Products do not include a “discarding state” because ports still receive data frames in the “discarding state,” which is inconsistent with the adopted construction that a “discarding state” is a state “in which data frames are neither forwarded to nor received from the port.” (*Markman* Order at 42; *see also infra* App. A Section II.B.). The DI Loop Guard Products also do not include a separate “listening port.” (JX-0050C at 135:9-12, 134:23-25.). Since the listening state is the same as the blocking state, DI Loop Guard Products also do not “transition” to a listening port state that can “return” to the blocking state. Accordingly, the DI Loop Guard Products do not practice limitation ii of claim 10 of the '875 patent.

iii. “a loop guard engine cooperating with the STP engine, wherein configuration bridge protocol data unit (BPDU) messages are periodically received at one or more of the device’s ports”

Dr. Wicker testified that the DI Loop Guard Products include a loop guard engine that cooperates with the STP engine, and in that configuration BPDU messages are periodically received at one or more of the device’s ports as part of the normal function of the spanning tree.

Public Version

(Tr. (Wicker) at 746:16–747:1, 823:10-14, 804:15-22, 817:24–820:16; CX-0647 at 2; CX-0608 at 98-99; CX-0641 at 25-3; CX-0340 at 6.).

Cisco claimed, and Arista did not dispute, that the DI Loop Guard Products meet this limitation. (CBr. at 108-09; RBr. at 110-11.). Because there is no dispute between Cisco and Arista, Cisco has met its burden of proof and proven by a preponderance of the evidence that the DI Loop Guard Products meet limitation iii of claim 10 of the '875 patent.

- iv. “in response to the periodic receipt of BPDUs being stopped on a given port, the loop guard engine (1) prevents the given port from transitioning to the forwarding spanning tree port state, if the given port is in a spanning tree port state other than the forwarding spanning tree port state, or (2) precludes the given port from forwarding or receiving network messages”*

Based on Dr. Wicker's testimony and Cisco's technical documents, the Loop Guard feature in the DI products prevents loop formation as a result of unilateral link failures by responding to the periodic receipt of BPDUs stopping, and either: (1) prevent the given port from transitioning to the forwarding spanning tree port state, if the given port is in a spanning tree port state other than the forwarding spanning tree port state; or (2) preclude the given port from forwarding or receiving network messages, if the given port is in the forwarding spanning tree port state. (Tr. (Wicker) at 820:17–822:14; CX-0340 at 179; CX-0418 at 32-17; CX-0608 at 4, 99; CX-0614 at 10-4; CX-0616 at 106; CX-0620 at 116; CX-0641 at 25-3; CX-0647 at 2).).

Cisco claimed, and Arista did not dispute, that the DI Loop Guard Products meet this limitation. (CBr. at 108-09; RBr. at 110-11.). Because there is no dispute, Cisco has met its burden of proof by a preponderance of the evidence that the DI Loop Guard Products meet limitation iv of claim 10 of the '875 patent.

- v. Conclusion*

Public Version

For the reasons set forth above in Section VI.E.1.c.ii, the DI Loop Guard Products do not practice claim 10 of the '875 patent. The DI Loop Guard Products do not practice claim 1 of the '875 patent because the DI Loop Guard Products do not include a “discarding state” and “listening state,” and do not “transition” to a “discarding state” or a “listening state,” under the adopted constructions set forth in Section II.B of Appendix A. (Tr. (Wicker) at 861:24–862:5; JX-0050C at 123:18-23; CX-0635C at 30; JX-0050C at 135:9-12, 134:23-25.).

d) Conclusion

To summarize, the DI Loop Guard Products do not practice any of the asserted claims of the '875 patent because the DI Loop Guard Products do not include a “discarding state” and a “listening state,” and do not “transition” to a “discarding state” or a “listening state.” (Tr. (Wicker) 861:24–862:5; JX-0050C at 123:18-23; CX-0635C at 30; JX-0050C at 135:9-12; 134:23-25.).

3. '492 Patent

a) Claim 1.

- i. “An intermediate network device configured to receive and forward network messages, the intermediate network device having a plurality of ports to connect the intermediate network device to one or more other devices, the intermediate network device comprising”*

Cisco claimed, and Arista did not dispute, that the DI Loop Guard Products meet the preamble above. (CBr. at 109; RBr. at 110-11.). The claim language recited in the preamble above is almost identical to the claim language contained in the preamble of claim 1 of the '875 patent. (JX-0006 at 13:5-9; JX-0004 at 13:10-15.). Therefore, the interpretation of this language for the '492 patent as described in Section VI.D.1.a.i, is the same here. The testimony for the '492 patent with regard to the preamble above is exactly the same as is cited in Section

Public Version

VI.D.1.a.i for the '875 patent. The end result is the same as well. Because there is no dispute, Cisco has met its burden of proof by a preponderance of the evidence that the DI Loop Guard Products meet the preamble of claim 1 of the '492 patent.

- ii. ***“one or more processing elements configured to execute a spanning tree protocol engine, the spanning tree protocol engine to implement a Rapid Spanning Tree Protocol (RSTP) to transition at least some of the intermediate network device’s ports among a plurality of port states, including a discarding port state, a listening port state, and a forwarding port state”***

Cisco has failed to meet its burden of proof to demonstrate by a preponderance of the evidence that the DI Loop Guard Products practice this limitation of claim 1 of the '492 patent. The claim language recited in the limitation above is also contained in claim 1 of the '875 patent. (JX-0006 at 13:10-16; JX-0004 at 13:10-15.). The testimony for this limitation of claim 1 of the '492 patent is exactly the same as is cited in Section VI.D.1.a.ii for the '875 patent. The end result is the same as well.

In summary, Dr. Wicker testified that the DI Loop Guard Products implement IEEE 802.1w, like the Accused Loop Guard Products. (RX-0360C at ¶ 323; *see also* JX-0050C at 123:18-23.). As such, the DI Loop Guard Products do not include a “discarding state” because ports still receive data frames in the “discarding state,” which is inconsistent with the adopted construction that a “discarding state” is a state “in which data frames are neither forwarded to nor received from the port.” (*Markman* Order at 42; *see also infra* App. A Section II.B.). The DI Loop Guard Products also do not include a separate “listening port.” (JX-0050C at 135:9-12, 134:23-25.). Since the listening state is the same as the blocking state, DI Loop Guard Products also do not “transition” to a listening port state that can “return” to the blocking state.

Public Version

Accordingly, the DI Loop Guard Products do not practice limitation ii of claim 10 of the '875 patent.

iii. “the one or more processing elements further configured to execute a loop guard engine, the loop guard engine to cooperate with the spanning tree protocol engine, the loop guard engine configured to, in response to a stoppage of a periodic receipt of bridge protocol data units (BPDUs) on a given port, prevent the given port from transitioning to the forwarding port state, if the given port is in a port state other than the forwarding port state”

Cisco claimed, and Arista did not dispute, that the DI Loop Guard Products meet this limitation. The claim language recited in the limitation above is almost identical to the claim language contained in claim 1 of the '875 patent. (JX-0006 at 13:17-24; JX-0004 at 13:19-26.). Therefore, the interpretation of this language for the '492 patent as described in Section VI.D.1.a.iv, is the same here. The testimony for the '492 patent with regard to the limitation above is exactly the same as is cited in Section VI.D.1.a.iv for the '875 patent. The end result is the same as well. Because there is no dispute, Cisco has met its burden and demonstrated by a preponderance of the evidence that the DI Loop Guard Products meet limitation iii of claim 1 of the '492 patent.

iv. Conclusion

It is a finding of this Initial Determination that the DI Loop Guard Products do not infringe claim 1 of the '492 patent because the DI Loop Guard Products do not include a “discarding state” and a “listening state,” and do not “transition” to a “discarding state” or a “listening state,” under the adopted constructions. (Tr. (Wicker) at 861:24–862:5; JX-0050C at 123:18-23; CX-0635C at 30; JX-0050C at 135:9-12, 134:23-25.).

b) Claims 3 and 4.

The DI Loop Guard Products do not practice claim 1 of the '492 patent because these products do not include a “discarding state” and a “listening state,” and do not “transition” to a “discarding state” or a “listening state,” under the adopted constructions set forth in Section II.B of Appendix A. Since dependent claims 3 and 4 of the '492 patent ultimately depend from claim 1, the DI Loop Guard Products do not practice claims 3 and 4. *See Alloc*, 342 F.3d at 1375 (“The test for satisfying the ‘technical prong’ of the domestic industry requirement is essentially [the] same as that for infringement, i.e., a comparison of domestic products to the asserted claims.”); *Muniauction*, 532 F.3d at 1328-29 n.5 (“A conclusion of noninfringement as to the independent claims requires a conclusion of noninfringement as to the dependent claims.”); *Monsanto*, 503 F.3d at 1359 (“One who does not infringe an independent claim cannot infringe a claim dependent on (and thus containing all the limitations of) that claim.”); *Wahpeton Canvas*, 870 F.2d at 1553 (“It is axiomatic that dependent claims cannot be found infringed unless the claims from which they depend have been found to have been infringed.”).

F. Validity

1. Anticipation by Di Benedetto

Arista alleged that U.S. Patent No. 7,076,594 to Di Benedetto *et al.* (“Di Benedetto”) anticipates claims 1-4 and 10 of the '875 patent and claims 1, 3, and 4 of the '492 patent. (RBr. at 111; RX-0234.). Di Benedetto issued on July 11, 2006, from U.S. Patent Application No. 09/747,676, filed on December 22, 2000. (RX-0234.). Arista asserted that Di Benedetto is prior art to the '875 and '492 at least under 35 U.S.C. § 102(e), (f), and (g)(2).⁸⁷ (RPBr. at 143; RBr.

⁸⁷ Prior to the America Invents Act (“AIA”), 35 U.S.C. § 102(e), (f), (g)(1) and (g)(2) read, in relevant part: “A person shall be entitled to a patent unless—

Public Version

at 111.). The technology disclosed in the Di Benedetto reference is directed to an “uplinkguard” feature that, when enabled on a port, prevents the port from transitioning to the designated role. (RX-0234 at Abstract, 2:49-51, 3:2-3.). “When the port attempts to transition into designated role, Uplinkguard forces the port to transition into blocked role.” (*Id.* at Abstract, 3:4-5.).

(e) the invention was described in (1) an application for patent, published under section 122(b), by another filed in the United States before the invention by the applicant for patent or (2) a patent granted on an application for patent by another filed in the United States before the invention by the applicant for patent, except that an international application filed under the treaty defined in section 351(a) shall have the effects for the purposes of this subsection of an application filed in the United States only if the international application designated the United States and was published under Article 21(2) of such treaty in the English language; or
(f) he did not himself invent the subject matter sought to be patented, or
(g)(1) during the course of the an interference conducted under section 135 or section 291, another inventor involved therein establishes, to the extent permitted in section 104, that before such person’s invention thereof the invention was made by such other inventor and not abandoned, suppressed, or concealed, or
(g)(2) before such person’s invention thereof, the invention was made in this country by another inventor who had not abandoned, suppressed, or concealed it. In determining priority of invention under this subsection, there shall be considered not only the respective dates of conception and reduction to practice of the invention, but also the reasonable diligence of one who was first to conceive and last to reduce to practice, from a time prior to conception by the other.”

Post-AIA, 102(e) is now in 102(a)(2); 102(f) and (g) are included in 102(a)(1). 35 U.S.C. § 102(a)(1) and (2) read as follows: “(a) A person shall be entitled to a patent unless—

- (1) the claimed invention was patented, described in a printed publication, or in public use, on sale, or otherwise available to the public before the effective filing date of the claimed invention; or
- (2) the claimed invention was described in a patent issued under section 151, or in an application for patent published or deemed published under section 122(b), in which the patent or application, as the case may be, names another inventor and was effectively filed before the effective filing date of the claimed invention.”

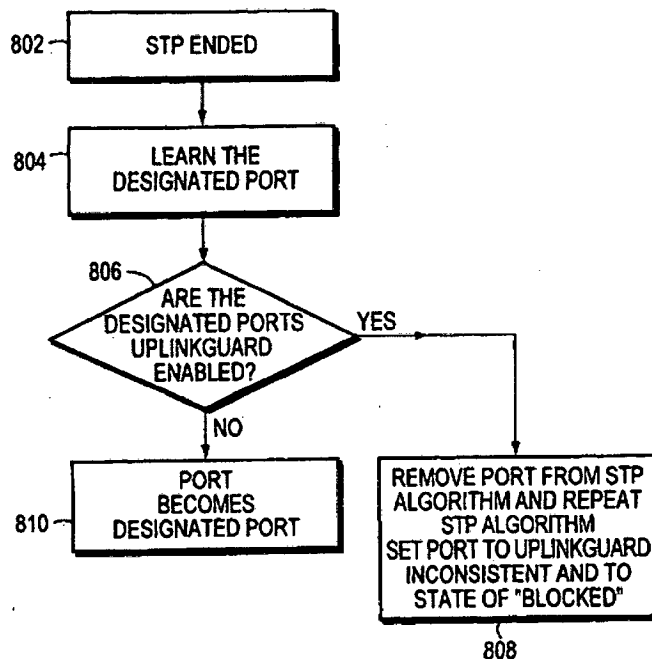

FIG. 8

(Id. at Fig. 8.).

i. Claims 1 and 10 of '875 Patent; Claim 1 of '492 Patent

In this case, Arista has not proven by clear and convincing evidence that the Di Benedetto reference discloses each and every limitation of independent claims 1 and 10 of the '875 patent and independent claim 1 of the '492 patent. As an initial matter, Arista is persuasive that Dr. Wicker's testimony is inconsistent with regard to the Di Benedetto reference. Specifically, Dr. Wicker's challenged that this reference discloses a device that *"in response to a stoppage of a periodic receipt of bridge protocol units (BPDUs) on a given port, prevent[s] the given port from transitioning to the forwarding state, if the given port is in a port state other than the forwarding port state,"* has been, at times, contradictory. For example, in his expert report, Dr. Wicker stated that "Benedetto resolves the one-way connectivity problem in an entirely different way using completely different technology that prevents *a port that stops receiving BPDUs*

Public Version

messages from *transitioning to the designated role*, rather than preventing the given port from transitioning to the forwarding spanning tree port state, as required in claim 1.” (RX-0361C at ¶ 190 (emphases in original)). In addition, at the hearing, he testified to the following:

Q: So when you read this, every time the system encounters a failure of the BPDU messages, that port is now X'd out of the system forever?

A: Exactly.

(Tr. (Wicker) at 2390:13-16.).

Somewhat contradictorily, Dr. Wicker also testified that “it is not correct that Di Benedetto in any way responds to a cessation of BPDUs.” (*Id.* (Wicker) at 2376:15-16.). Cisco relied on this latter testimony and additional testimony by Dr. Wicker to support its contention that Di Benedetto does not disclose a “loop guard engine” configured to prevent a given port from transitioning “*in response to*” to periodic receipt of BPDU messages being stopped on a given port. (*Id.* (Wicker) at 2376:9–2377:3 (emphasis added)). Dr. Wicker testified that the device described in Di Benedetto “simply prevents a transition regardless of its cause.” (*Id.* (Wicker) at 2376:14-15.).

Even if Dr. Wicker’s testimony seems confusing, nonetheless, Di Benedetto does not anticipate the asserted claims of the ’875 and ’492 patent because Arista has not clearly and convincingly established that Di Benedetto anticipates the asserted claims.

Arista has not shown that in response to not receiving BPDUs, Uplinkguard “prevent[s] the given port from transitioning to the forwarding state, if the given port is in a port state other than the forwarding port state,” as required in independent claims 1 and 10 of the ’875 patent and independent claim 1 of the ’492 patent. Dr. Wicker stated in his expert report that:

Dr. Mir’s analysis ignores other ways a port may transition to a forwarding port state, such as through the root port role designation. Benedetto makes clear that

Public Version

the Uplinkguard technology has no effect on the ports transitioning to ‘root port’ role and subsequently to the forwarding port state.

(RX-0361C at ¶ 192 (citing RX-0234 at 10:17-22, 4:36-45, 11:31-36); *see also* Tr. (Wicker) at 2401:15–2402:14.). Di Benedetto discloses the following:

When the STP algorithm executes, the Uplinkguard enabled ports 106A, 106B, 108A, 108B, 110A, and 110B are prevented by Uplinkguard from transitioning into the designated role. However, in the event that the STP algorithm chooses one of these ports, 106A, 106B, 108A, 108B, 110A, 110B, etc., as the switch “root port,” then *the port transitions to the root port role*. In transitioning to the root port role, the port communicates up the logical tree of the spanning tree, toward the root switch.

(RX-0234 at 4:36-45 (emphasis added); *see also id.* at 10:17-22.).

Moreover, Di Benedetto does not disclose a loop guard engine that would “preclud[e] the given port from forwarding or receiving network messages, if the given port is in the forwarding spanning tree port state,” as recited in claims 1 and 10 of the ‘875 patent. For example, Dr. Wicker testified that based on the disclosure in the Di Benedetto reference, “the Uplinkguard technology has no effect on the ports transitioning to root port role and subsequently to the forwarding port state.” (Tr. (Wicker) at 2401:9-12; *see also* RX-0234 at 11:31-35 (“Entry 914 at column 913 shows that the result of Uplinkguard being enabled is ‘Don’t Care,’ meaning that *a root port in the forwarding state is unaffected by Uplinkguard being enabled.*”) (emphasis added).).

For these reasons, claims 1 and 10 of the ‘875 patent and claim 1 of the ‘492 patent are not anticipated by Di Benedetto and, therefore, not invalid.

ii. Claims 2-4 of ‘875 Patent; Claims 3 and 4 of ‘492 Patent

Arista has not met its burden of proof to prove by clear and convincing evidence that the Di Benedetto reference discloses each and every limitation of claims 2-4 of the ‘875 patent and

Public Version

claims 3 and 4 of the '492 patent. In particular, Arista failed to clearly and convincingly prove that Di Benedetto teaches a "loop inconsistent [port] state," as required in all of these dependent claims, and that a given port can be "releas[ed]" from the loop inconsistent port state, as required by claim 4 in each patent.

Dr. Mir relied on the following disclosures in Di Benedetto in support of his testimony that the reference teaches the claimed "loop inconsistent [port] state":

Entry 022 at column 913 of "Yes" indicates that a port having Uplinkguard enabled which has the role of "designated" is set to the *state of "blocked" because it is inconsistent with Uplinkguard being enabled*. A port represented by entry 922 has been set to Uplinkguard inconsistent at block 808 of FIG. 8.

* * *

The one way connectivity fault problem is solved by the present invention, as can be understood by reference to the flow diagram of FIG. 8, along with the Port State Table of FIG. 9. In the event that a port is in Blocked status, and the port fails to receive BPDUs, then the port attempts to transition to Forwarding status and begin [sic] transmitting BPDUs in order to initiate execution of the STP algorithm. In the event that the port has Uplinkguard enabled, and the port attempts to transition to designated role, *the port will be prevented from making this transition by Uplinkguard and will be placed permanently in Blocked status*. The port is thereby prevented from forming a loop in the network, and the one way connectivity problem is solved.

(Tr. (Mir) at 1999:20–2000:20; RX-0234 at 12:1-6, 12:15-29 (emphases added)). However, it is not clear from the identified disclosures whether a port state of "Uplinkguard inconsistent" is a distinct port, as required by the claims, or whether it is the same as a "blocked" port state. In fact, the emphasized text in the passage above seems to suggest the latter. Dr. Mir's conclusory testimony on which Arista relied also does not make this clear. (Tr. (Mir) at 1999:20–2000:20).

Additionally, Arista pointed to Dr. Wicker's testimony, referenced below, in support of its contention that "'Uplinkguard Inconsistent' port state disclosed by Di Benedetto is quite literally just the claimed 'Loop Inconsistent' port state of the '875 and '492 patents by another

name.” (RBr. at 114; RRB. at 79.).

Q: And they thought maybe that Uplinkguard wasn’t the best name and so we needed to come up with a new name for this particular feature; correct?

A: Well, I guess if we assume that the feature we’re referring to is what was eventually called uplink—excuse me, loop guard, so yes, that would follow.

(Tr. (Wicker) at 2394:20-25.). Dr. Wicker simply confirmed that the name of the feature was changed from “Uplinkguard” to “loop guard.” (*Id.*).

Arista also relied on testimony from Mr. Kaluve, one of the named inventors of the ’875 and ’492 patents and a former Cisco engineer who worked on Uplinkguard at Cisco, that he consulted with Mr. Di Benedetto, at some point, while developing this feature. (JX-0050C at 31:13–32:19, 96:19-23.). Additionally, Arista relied on a Cisco technical document discussing “LoopGuard” and specifically, the name change from “Uplinkguard” to “LoopGuard.” (RX-0233C at 9.). However, none of this evidence clearly and convincingly demonstrates that “Uplinkguard Inconsistent” as disclosed in Di Benedetto functions in the same way as the claimed “loop guard inconsistent.” Thus, the evidence adduced by Arista does not clearly and convincingly prove that “Uplinkguard Inconsistent” identified by Arista is a distinct port state that is “precluded from forwarding or receiving network messages and which is entered into in response to the receipt of BPDU messages being stopped,” as the term “loop inconsistent [port] state” has been construed. (*See supra* Section VI.B.1.).

For these reasons, claims 2-4 of the ’875 patent and claims 3 and 4 of the ’492 patent are not invalid as anticipated by Di Benedetto.

2. Patent Eligibility

Arista argued that the asserted claims of the ’875 and ’492 patents cover patent-ineligible

Public Version

subject matter under 35 U.S.C. § 101⁸⁸ because they claim the abstract idea of preventing ports that stop receiving configuration messages from forwarding data in a spanning tree algorithm. (RBr. at 115.). Arista's arguments, however, are flawed. The '875 and '492 patents are not directed to an abstract idea, but rather to a specific device, namely an intermediate network device or switch that includes an STP engine, a loop guard engine, and a plurality of ports for receiving and forwarding network messages. (JX-0004 at Abstract, 5:8-39; JX-0006 at Abstract, 5:12-29.). Dr. Wicker's testimony was far more explanatory and convincing.

Q: Okay. Now, Dr. Mir claimed that the asserted claims of the '875 and 492 patents are directed at an abstract idea. Do you agree with that?

A: No, no. In fact, if you look at the claims, they quite specifically say that we're dealing with an intermediate networking device and looking at a *specific technological advance within that intermediate networking device*.

Q: And Dr. Mir also testified that spanning tree is just an algorithm and thus these claims must be invalid. Do you agree with that?

A: No, no. These claims implement a spanning tree protocol in an *actual physical device*, and then make *specific modifications to that physical device*. Namely, adding this loop guard functionality to various ports within the switch. I don't agree. I don't agree at all.

(Tr. (Wicker) at 2380:14–2381:5 (emphases added).).

As Dr. Wicker testified, in the passage above, the intermediate network devices and structures contained therein involve physical systems that are designed to execute specific steps. For example, the claim elements reciting the Loop Guard technology involve physical changes to ports in a computer network in response to not receiving BPDUs messages. (Tr. (Wicker) at 2381:6-24, 2395:19-20.). Accordingly, the '875 and '492 patents do not simply recite a

⁸⁸ 35 U.S.C. § 101 reads as follows: "Whoever invents or discovers any new and useful process, machine, manufacture, or composition of matter, or any new and useful improvement thereof, may obtain a patent therefor, subject to the conditions and requirements of this title."

Public Version

“combination of steps . . . having no particular concrete or tangible form.” *Ultramercial, Inc. v. Hulu, LLC*, 772 F.3d 709, 715 (Fed. Cir. 2014).

It is also clear that claims 1-4 and 10 of the '875 patent and claims 1, 3 and 4 of the '492 patent are not directed to just an algorithm or mathematical concept, as Arista's expert, Dr. Mir, opined (Tr. (Mir) at 2001:11-15). *Cf. Diehr*, 450 U.S. at 187 (“a process is not unpatentable simply because it contains a law of nature or a mathematical algorithm”). The claims provide concrete networking technology for accomplishing a specific improvement to the intermediate network device in order to overcome shortcomings in “conventional industry practice.” *Alice*, 134 S. Ct. at 2358 (“[The Supreme Court] held that a computer-implemented process for curing rubber was patent eligible, but not because it involved a computer. The claim employed a ‘well-known’ mathematical equation, but it used that equation in a process designed to solve a technological problem in ‘conventional industry practice.’”) (quoting *Diehr*, 450 U.S. at 177-78). In particular, the Loop Guard functionality responds to the specific problem of unilateral link failure in the context of intermediate network devices operating an STP. *See, e.g., DDR Holdings, LLC v. Hotels.com, L.P.*, 773 F.3d 1245, 1257 (Fed. Cir. 2014) (finding that the claims at issue were patent-eligible because they were “rooted in computer technology in order to overcome a problem specifically arising in the realm of computer networks”).

Even if the asserted claims of the '875 and '492 patents are directed to an algorithm or a mathematical concept, the claims at issue do not merely add generic computer components, as was the case in *Alice*. *Alice*, 134 S. Ct. at 2358 (noting that “the mere recitation of a generic computer cannot transform a patent-ineligible abstract idea into a patent-eligible invention”). The claim elements at issue in *Alice* involved the use of a computer to create and maintain “shadow” accounts, i.e., “electronic recordkeeping,” which the Court concluded was “a generic

Public Version

computer function[].” *Id.* at 2359. The ’875 and ’492 patents involve an inventive step that addresses the problem of loop formations not detected by STPs or protocol, that is, a networking switch functionality that responds to a port’s failure to receive periodic BPDUs messages (*see, e.g., JX-0004 at 5:6-8; JX-0006 at 5:10-12; Tr. (Wicker) at 2381:14-24*). *See, e.g., Alice*, 134 S. Ct. 2357-58 (the elements of a claim must be examined “to determine whether it contains an ‘inventive concept’ sufficient to ‘transform’ the claimed abstract idea into a patent-eligible application”) (citing *Mayo Collaborative Servs. v. Prometheus Labs., Inc.*, 132 S. Ct. 1289, 1294, 1298 (2012)).

For these reasons, claims 1-4 and 10 of the ’875 patent and claims 1, 3, and 4 of the ’492 patent are not invalid as patent ineligible under 35 U.S.C. § 101.

VII. The ’668 Patent

A. Person of Ordinary Skill in the Art

A person of ordinary skill in the art for the ’668 Patent has been defined as someone who holds at least a Bachelor of Science degree in electrical engineering, computer engineering, or computer science, or an equivalent degree, and has approximately two years of related experience in the field of network devices. (*Markman Order at 52.*). Additional formal education in a relevant field, such as work toward a master’s degree, would have reduced the amount of industry experience one of skill would have needed in the art. (*Id.*).

B. Disputed Terms

1. Claims 1, 55—“port services”⁸⁹

Cisco’s Proposed Construction	Arista’s Proposed Construction	Staff’s Proposed Construction
-------------------------------	--------------------------------	-------------------------------

⁸⁹ Joint Claim Construction Report at Attach. A, p. 10.

Public Version

input and/or output services applied to packets entering into or exiting from a port	policies or rules applied to packets	input and/or output services applied to packets entering into or exiting from a port
--	--------------------------------------	--

According to claim 1 of the '668 patent, port services “operat[e] on packets entering and exiting the physical network interface ports” and “provid[e] an ability to control and monitor packet flows.” (JX-2 ('668 patent) at 9:23-25.). The specification explains that port services are “applied to operate on packets entering into or exiting from each individual physical port.” (*Id.* at 3:40-41.). Therefore, a person of ordinary skill in the art would understand “port services” to mean “input and/or output services applied to packets entering into or exiting from a port.”

Arista proposes that this term means “policies or rules applied to packets” based on claim 17. (RBr. at 19 (citing JX-2 at 4:35-38, fig. 5).). Dependent claim 17 recites “wherein the services applied to the control plane port are selected from the group consisting of Quality of Service (QoS) functions, packet classification, packet marking, packet queuing, packet rate-limiting flow, control, or other access policies for packets destined to the control plane port.” (JX-2 at 10:24-29.).

First, dependent claim 17 defines the control plane port services, not the port services. Second, even if dependent claim 17 limits the port services to certain exemplary policies, the port services in independent claim 1 is not so limited. *See Phillips*, 415 F.3d at 1315 (“[T]he presence of a dependent claim that adds a particular limitation gives rise to a presumption that the limitation in question is not present in the independent claim.”). Indeed, Cisco’s expert, Dr. Almeroth, testified during the hearing that policies or rules are “examples” of port services. (Tr. (Almeroth) at 1048:3-5.). Therefore, although port services may include policies or rules, port services are not limited to only policies or rules, as Arista argued.

Public Version

2. Claims 1-2, 5, 13, 56—“control plane port entity”/“control plane port”⁹⁰

Cisco’s Proposed Construction	Arista’s Proposed Construction	Staff’s Proposed Construction
an access path for packets to access control plane processes	one or more physical ports or a virtual location with a unique address to which packets bound for the control plane are forwarded	single access path required for packets to access control plane processes

According to claim 1, a control plane port entity “provides access to the collection of control plane processes, so that a set of control plane port services can be applied thereto.” (JX-2 at 9:33-35.). Similarly, claim 2 states that “the control plane processes are accessible through a control plane port.” (*Id.* at 9:42-43.). Dependent claims 5 and 6 recite that “control packets are identified and forwarded to the control plane port.” (*Id.* at 9:56-59.). Claim 13 recites that “one or more distributed switch engines deliver packets to the control plane port.” (*Id.* at 10:13-14.). Claim 56 requires “passing packets through the control plane port, rather than directly from the physical ports to individual control plane processes.” (*Id.* at 13:38-40.). Therefore, the language of claim 1, as well as the further limitations of the dependent claims, supports construing the terms “control plane port entity” and “control plane port” to mean “a single access path required for packets to access control plane processes.”

The specification also supports this construction. The ’668 patent defines a control plane port **140** as “a single access path between the switch engine **130** and the control plane **150**.” (*Id.* at 4:66-67.). “Packets, which are destined to specific control plane processes, are now destined through that specific control plane port, such that such packets intended for the control plane

⁹⁰ Joint Claim Construction Report at Attach. A, p. 10.

Public Version

always pass through this designated port.” (*Id.* at 3:51-54.). The control plane port **140** may be a single physical port or it may be a virtual address through which packets travel or are routed from the data plane **135** to the control plane **150**. (*Id.* at 5:1-4.). Figures 1 and 2 of the ’668 patent illustrate a control plane port **140** as a single arrow between the control plane **150** and the data plane **135**. (*Id.* figs. 1-2.). “Central switch engine **130** executes the input port services for the control plane port **140** making routing decisions for packets designated for the control plane **150**.” (*Id.* at 6:61-64.). Therefore, according to the specification, packets access the control plane through the control plane port.

Arista proposed that the terms mean “one or more physical ports or a virtual location with a unique address to which packets bound for the control plane are forwarded.” (RBr. at 20 (citing JX-2 at 3:48-50, 5:1-4, 8:51-54).). However, that the packets are forwarded to the control plan port is a requirement of dependent claims 5 and 6. (JX-2 at 9:56-59.). Additionally, the uniqueness of the control plane port and the associated control plane port services is recited in dependent claim 18. (*Id.* at 10:30-32.). The other claims, specifically claims 1-2, 13, and 56, in which the terms appear do not necessarily include the forwarding and uniqueness requirements. (*Id.* at 9:17-47, 10:14-15, 13:11-40.). Therefore, it would be improper to construe these terms that are present in other claims so narrowly. *See Phillips*, 415 F.3d at 1315 (“[T]he presence of a dependent claim that adds a particular limitation gives rise to a presumption that the limitation in question is not present in the independent claim.”). Furthermore, the specification discloses embodiments that include an exemplary control plane port **140** as a physical port or a uniquely addressable virtual port. (JX-2 at abstract, 3:48-50, 5:1-4, 8:52-54.). The limitations of exemplary embodiments in the specification should not be read into the claims. *See Phillips*, 415 F.3d at 1323 (warning against reading limitations from the specification into the claims).

3. Claim 7—“multiple processors”⁹¹

Cisco’s Proposed Construction	Arista’s Proposed Construction	Staff’s Proposed Construction
Plain and ordinary meaning. If the term needs to be construed, “multiple functional entities that may run processes.”	processors contained on more than one physical integrated circuit chip	Plain and ordinary meaning.

Dependent claim 7 recites that “the control plane processes are distributed across multiple processors.” (JX-2 at 9:60-61.). The ’668 patent uses the reference number “155” to designate the control plane processes in the specification but uses the same reference number 155 to

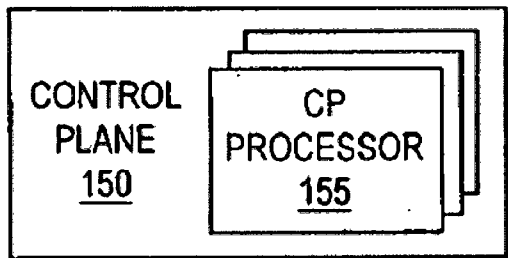

designate the control plane processor in Figure 1. (*Id.* at 5:64-65, fig. 1.). Moreover, Figure 1 of the ’668 patent depicts three boxes to show multiple control plane processors 155. (*Id.* fig. 1.). The patent further

discloses, “The control plane 150 is typically not a single process or processor but rather a collection of processes.” (*Id.* at 5:21-23.). “These control plane 150 processes could be implemented as software at any level of a system, or as hardware.” (*Id.* at 4:62-64.).

“[T]he words of a claim ‘are generally given their ordinary and customary meaning.’” *Phillips*, 415 F.3d at 1312 (quoting *Vitronics Corp. v. Conceptor, Inc.*, 90 F.3d 1576, 1582 (Fed. Cir. 1996)). None of the parties provides persuasive reasons for deviating from the plain and ordinary meaning of “multiple processors.” In support of its proposed construction, Arista’s initial post-hearing brief points to the “multiple distinct and separate components called ‘CP

⁹¹ Joint Claim Construction Report at Attach. A, p. 10.

Public Version

Processor” in Figure 1 of the '668 patent. (RBr. at 20 (citing JX-2 fig. 1).). However, there is no intrinsic or extrinsic evidence (e.g., a description in the specification or expert testimony) that the three boxes labeled “CP Processor 155” in Figure 1 of the patent represent multiple physical integrated circuit chips. Since the specification discloses that the control plane processes could be implemented in software or hardware, those three boxes in Figure 1 could represent three software modules or three processors within a single chip. (*See* JX-2 at 4:62-64.). Therefore, Arista’s proposal to define “multiple processors” such that they must be contained on more than one physical integrated circuit chip is unduly limiting.

Arista’s initial Post-Hearing Brief cites to Barron’s Dictionary of Computer and Internet Terms (8th edition 2003) for its definition of “processor.” (RBr. at 20 (citing RX-0456 at 118, 393, 316).). For the definition of “processor,” the dictionary refers the reader to “*see* MICROPROCESSOR; COPROCESSOR; CPU.” (RX-456 at 393.). The dictionary defines the term “microprocessor” as “an integrated circuit containing the entire CPU of a computer, all on one silicon chip,” the term “coprocessor” as “a separate circuit inside computer that adds additional functions to the CPU central processing unit,” and the term “CPU” as “the part of computer where arithmetic and logical operations are performed and instructions are decoded and executed.” (*Id.* at 115, 118, 316.).

However, even if microprocessors and coprocessors are each on separate silicon chips, the '668 patent does not use the terms “microprocessor” or “coprocessor.” Moreover, the '668 patent discloses that the control plane processes may be implemented as software “at any level” or as hardware. (JX-2 at 4:62-64.). The patent is completely silent about whether the control plane processes must be on a single or multiple chips. The patent’s broad descriptions of how the control plan processes can be implemented should not be overridden by specific dictionary

Public Version

definitions of terms are that not even used in the patent. *See Phillips*, 415 F.3d at 1321

(“[H]eavy reliance on the dictionary divorced from the intrinsic evidence risks transforming the meaning of the claim term to the artisan into the meaning of the term in the abstract, out of its particular context, which is the specification.”).

4. Claim 8—“*aggregate control plane function*”⁹²

Cisco’s Proposed Construction	Arista’s Proposed Construction	Staff’s Proposed Construction
centralized control plane port function applied to all control plane packets from any port on the device	control plane port function collectively applied at a central level	centralized control plane port function applied to all control plane packets from any port on the device

Dependent claim 8 recites that “the control plane port services are implemented as an aggregate control plane function applied to packets received from multiple physical ports on the internetworking device.” (JX-2 at 9:62-65.). Dependent claim 9 recites that “a central switch engine performs the aggregate control plane port services.” (*Id.* at 9:66-67.). The specification discloses:

If . . . the packet is destined for a known control plane **150** address, . . . the packet is tagged being destined to as [sic] a control plane port. The packet is then routed through the aggregate control plane port **140**. In state **405** the control plane port **140** then performs the aggregate control plane port services on the packet. In a state **410**, based on the results of the aggregate control plane services function **145**, the control plane port function will either drop the packet, or mark the packet and potentially deliver it to the control plane **150** for processing.

(*Id.* at 7:8-18.). Similarly, the specification discloses that “a route processor . . . identif[ies] candidate packets destined to the control plane port enabling those packets to be processed by the aggregate control plane port services.” (*Id.* at 3:64-67.). “The central, aggregate control plane

⁹² Joint Claim Construction Report at Attach. A, p. 10.

services **145** provide a level of service (or control) for all packets received from any port on the device **100**.” (*Id.* at 6:48-50.). “[T]he central switch engine **130** can provide an aggregate level of control plane service **145**, which is applied to all control plane packets received from all interfaces.” (*Id.* at 6:58-61.). In summary, the central switch engine applies the aggregate control plane function to all packets that are destined for the control plane from any port. Therefore, one of ordinary skill in the art would understand the term “aggregate control plane function” to mean “centralized control plane port function applied to all control plane packets from any port on the device.”

With respect to Arista’s proposed construction, the specification discloses that “the control plane [sic] processes are collectively arranged as a single addressable entity” and “[t]hese control plane **150** processes collectively provide high level control for most router/ switch Input/Output Services (IOS) functions.” (*Id.* at 3:44-46, 4:60-62.). However, Arista provided no support for its proposal that the aggregate control plane function be “collectively applied.”

Arista also argued that Cisco and Staff’s proposed construction is incorrect, because the aggregate control plane function is not applied to “all control plane packets” if a distributed control plane service decides to drop a packet. (RBr. at 21 (citing JX-2 at 8:16-19).). In reference to Figure 6, the specification discloses the following sequence of steps: a packet is received from a port on the device; the distributed switch engine determines whether the packet is destined to the control plane; if so, the distributed switch engine performs the distributed control plane services on the packet and either drops the packet or delivers the packet to the central switch engine; and if the packet is not dropped, the central switch engine applies the aggregate control plane function on the packet and either drops the packet or delivers the packet to the control plane. (JX-2 at 8:3-24, fig. 6; *see also id.* at 7:15-18.).

Public Version

It appears that the aggregate control plane function can be applied only to packets that are received by a port on the device and have been passed to the control plane engine by the distributed switch engine. That some packet never reach the control plane does not render the language “*all* control plane packets” incorrect. The word “all” modifies “control plane packets” and Arista has misread Cisco’s and Staff’s proposal as encompassing packets that are not received by the central switch engine and to which it would be impossible to apply the aggregate control plane function. (CBr. at 7.).

5. Claims 10, 64—“distributed control plane port services”⁹³

Cisco’s Proposed Construction	Arista’s Proposed Construction	Staff’s Proposed Construction
non-centralized control plane port services applied only to control plane packets from the ports with which they are associated	control plane port services provided at the line card level	non-centralized control plane port services applied only to control plane packets from the ports with which they are associated

Dependent claim 10 requires that: (1) “the control plane port services are implemented as distributed control plane port services”; and (2) “the distributed control plane port services are applied only to the packets received from the specific, pre-determined physical ports.” (*Id.* at 10:1-5.). Dependent claim 64 recites the second requirement of claim 10. (*Id.* at 14:15-17.). Figure 3 of the ’668 patent, reproduced below, illustrates the difference between aggregate and distributed control plane services.

⁹³ Joint Claim Construction Report at Attach. A, p. 10.

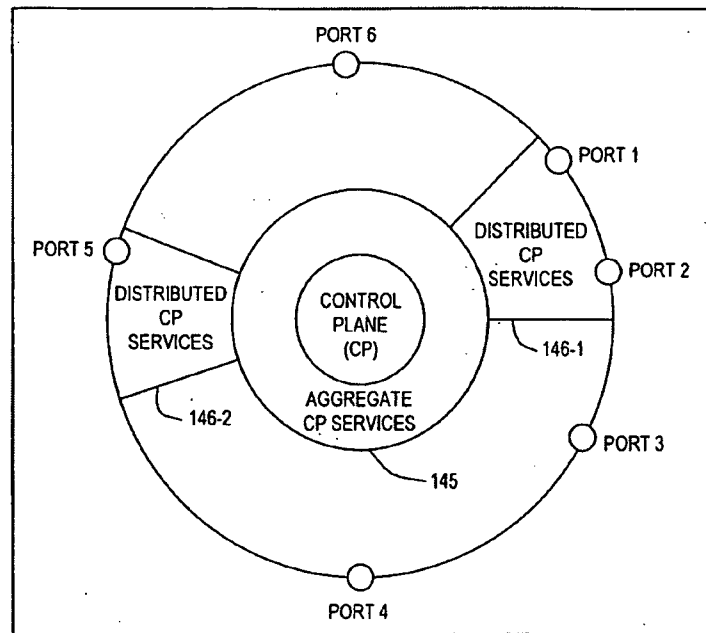

(*Id.* fig. 3.). The specification discloses, “The central, aggregate control plane services 145 provide a level of service (or control) for all packets received from any port on the device 100. The distributed control plane services 146 provide a level of service (or control) only for those parts with which they are associated, which may be a single port 120 or multiple ports 120.” (*Id.* at 6:48-54.).

Therefore, the '668 patent describes the aggregate control plane services as being “central,” whereas the distributed control plane services are non-centralized. (*Id.* at 6:48.). Furthermore, the claims require and the specification describes that the distributed control plane services are applied to only the packets from specific ports associated with the distributed control plane services. (*Id.* at 6:50-7:3, 10:1-5, 14:15-17.). For example, as illustrated in Figure 3, “ports 1 and 2 [are] serviced by distributed services module 146-1,” whereas “port 5 . . . is serviced by a different distributed services module 146-2.” (*Id.* at 6:54-57.). Therefore, one of ordinary skill in the art would understand the term “distributed control plane port services” to

mean “non-centralized control plane port services applied only to control plane packets from the ports with which they are associated.”

Arista’s proposal that the term means “control plane port services provided at the line card level”⁹⁴ is too limiting. Neither claim 10 nor 64 requires that the distributed control plane services be provided at the line card level. (*Id.* at 10:1-5, 14:15-17.). Furthermore, the specification discloses that it is optional to have the distributed switch engine executed at the line card level. (*Id.* at 7:64-66 (“The distributed switch engine is such that portions may execute on line cards **111**, and other portions may execute in a central location to make the routing decision.”).).

6. Preamble of Claim 55⁹⁵

Although Cisco’s and Staff’s initial post-hearing briefs assert that the preamble of claim 55 is limiting, Arista’s initial post-hearing brief fails to address this issue, and therefore Arista has waived it. *See* G.R. 15.1.1 (“Any factual or legal issues not addressed in the post-hearing briefs shall be deemed waived.”). Accordingly, the preamble of claim 55 is limiting.

C. Infringement

1. Accused ’668 Products

Cisco has accused Arista’s networking switches 7010, 7048, 7050, 7050X, 7150, 7250X, 7280E, 7300, and 7500E (“the ’668 Accused Products”) of directly and indirectly infringing claims 1, 2, 4, 5, 7, 8, 10, 13, 18, 56, and 64 of the ’668 patent. (*See* CBr. at Attach. B; *see also* Appendix B.). The ’668 Accused Products fall into two categories. [

⁹⁴ Line cards include ports through which a physical connection to the network is made. (JX-0002 at 4:51-55.).

⁹⁵ Joint Claim Construction Report at Attach. A, p. 11.

] (See, e.g., CX-0091C at 4.).

[

] (See, e.g., CX-0088 at 16, 28, 45.).

Each of the '668 Accused Products uses the “Extensible Operating System” (“EOS”). (Tr. (Metivier) at 2048:9-12; CX-0268 at 2.). The EOS software runs one or more of the following control plane protection features: (1) Control-Plane Access Control List (“CP-ACL”); (2) Control Plane Policing (“CoPP”); and/or (3) Per-Input Port Control Plane Policing (“PiP CoPP”). (Tr. (Almeroth) at 1037:20–1038:4; CDX-0013C-052; JX-0032C at 311:21–312:9; Tr. (Mir) at 1616:14–1617:7.).

[

] (See, e.g., RX-0537; RX-

0547.). [

] (See, e.g.,

RX-0539; RX-0547; RX-0375.). [

] (See, e.g., RX-0549; RX-0550;

RX-0551.).

⁹⁶ Supervisor modules are hardware cards that can be inserted into a modular chassis (i.e., pluggable). (Tr. at 1083:24-1084:3, 1794:21-25.). Supervisor modules run the switch (*Id.* at 1084:7-13.). Supervisory modules, which is part of the control plane, include CPUs on which the EOS software runs. (*Id.* at 1084:7-18, 1117:21-1118:2, 1618:8-11, 1619:10-13, 2050:7-14, 2051:16-19.).

⁹⁷ Linux is an open-source operating system. (Tr. at 55:23, 92:14.).

⁹⁸ Throughout their briefing, the parties use different terms when referring PiP CoPP. Cisco uses the term “PiP CoPP” to include both the per-input-port and non-configurable aspects. (See, e.g., CBr. at 25-27.). Arista identifies the per-input-port aspect of PiP CoPP as “Software Release 4.15.1FXB” or simply “PiP CoPP” while referring to the non-configurable aspect as “non-configurable CoPP.” (See RBr. at 23-24.). Staff refers to the per-input-port aspect as “Software Release 4.15.1FXB,” and the non-configurable aspect as “global” or “non-configurable” aspects of Software Release 4.15.1FXB. (SBr. at 27-28.). Dr. Almeroth’s testimony discusses non-configurable PiPP CoPP as a part of PiP CoPP. (See Tr. (Almeroth) at 1078:22-25 (“even as part of per input port CoPP, there’s some packets that don’t get the per input port”).).

Public Version

All of the '668 Accused Products have enabled by default both the CoPP and CP-ACL features. (Tr. (Almeroth) at 1029:22–1030:13; CDX-0013C-065; CX-0285; CX-0286). [] (Tr. (Almeroth) at 1033:24–1034:8; CDX-0013C-69; CDX-0013C-052; JX-0032C at 311:21–312:9).

2. Direct Infringement

Cisco has accused the '668 Accused Products of directly infringing claims 1, 2, 4, 5, 7, 8, 10, 13, 18, 56, and 64 of the '668 patent. (*See* CBr. at Attach. B.). As discussed in more detail below, on a claim-by-claim basis, the record evidence proves by a preponderance of the evidence that the '668 Accused Products directly infringe the asserted claims of the '668 patent.

Specifically, each of the '668 Accused Products includes the elements of the asserted claims, including: a plurality of physical network interface ports, port services, a control plane, a control plane port entity, and control plane port services operating on packets received from specific, predetermined physical ports and destined to the collection of control plane processes in a way that is independent of the physical port interfaces and services. Dr. Almeroth, one of Cisco's experts who analyzed Arista's source code, technical documents, and witness testimony, testified that the '668 Accused Products infringe the asserted claims.

Arista's main non-infringement argument is that the accused CP-ACL and CoPP features in the '668 Accused Products do not apply access control lists or policies to packets from specific, predetermined ports. (RBr. at 24-30.). Arista also argued that the per-input-port PiP CoPP feature does not operate in a way that is independent of the physical port interfaces and services. (RBr. at 30-36.). However, the evidence reflects that under the adopted constructions of "specific, predetermined ports" and "independent of the [individual] physical port interfaces

Public Version

[configuration] and services,” the ’668 Accused Products that have the CP-ACL, CoPP, and per-input-port PiP CoPP features meet these limitations.

a) Claims 1 and 55.

Cisco has alleged that the ’668 Accused Products directly infringe, *inter alia*, claims 1, 56 and 64 of the ’668 patent. Although claim 55 was not asserted in this Investigation, claims 56 and 64 depend from claim 55. Thus, a separate analysis of claim 55 is necessary to assess infringement of claims 56 and 64.

- i. “[A computer readable storage medium containing instructions readable by a computer to configure the computer to perform a method for processing packets in] An internetworking device comprising”**

Cisco claimed, and Arista did not dispute, that all of the ’668 Accused Products meet the preamble of claims 1 and 55 of the ’668 patent. (CBr. at 17; RBr. at 24-37.). Dr. Almeroth testified that all of ’668 Accused Products are internetworking devices. (Tr. (Almeroth) at 1043:15–1044:5.). Dr. Almeroth’s testimony was corroborated by Mr. Holbrook, Vice President of Software Engineering at Arista, that Arista “sell[s] Ethernet switches, which is a type of networking equipment.” (Tr. (Holbrook) at 1780:19-24.). Dr. Almeroth also opined that the ’668 Accused Products also include computer-readable storage media on supervisor modules for storing Arista’s EOS software, which control and configure the infringing CoPP, CP-ACL, and PiP CoPP features. (Tr. (Almeroth) at 1090:23–1092:1.). Accordingly, because there is no dispute, Cisco has met its burden by a preponderance of the evidence that the preamble of claims 1 and 55 of the ’668 patent is met by the ’668 Accused Products.

- ii. “[configuring] a plurality of physical network interface ports, each for providing a physical connection point to a network for the internetworking device, the ports being configurable by control plane processes”**

Public Version

Cisco claimed, and Arista did not dispute, that all of the '668 Accused Products meet this limitation. (CBr. at 17; RBr. at 24-37.). Dr. Almeroth testified that based, *inter alia*, on an Arista EOS user manual (CX-0221),⁹⁹ all of the '668 Accused Products have a plurality of network interface ports that are configurable by control plane processes, which Dr. Mir, Arista's expert, did not dispute. (Tr. (Almeroth) at 1044:6–1046:9; Tr. (Mir) at 1731:25–1732:18; CX-0221; CDX-0013C-082.). Accordingly, because there is no dispute between Cisco and Arista, Cisco has met its burden and demonstrated by a preponderance of the evidence that the '668 Accused Products meet limitation ii of claims 1 and 55 of the '668 patent.

iii. “[executing] port services, for operating on packets entering and exiting the physical network interface ports, the port services providing an ability to control and monitor packet flows, as defined by control plane configurations”

Cisco claimed, and Arista did not dispute, that all of the '668 Accused Products meet this limitation. (CBr. at 18; RBr. at 24-37.). Dr. Almeroth testified, and Dr. Mir does not dispute, that based, *inter alia*, on an Arista EOS user manual (CX-0221), all of the '668 Accused Products have port services, which include access control lists, such as Port, Router, or MAC ACLs, as well as QoS processes, such as storm control, that provide the ability to control and monitor packet flows. (Tr. (Almeroth) at 1046:9-18, 1047:9–1048:5, 1048:6–1049:4, 1049:5-15; Tr. (Mir) at 1731:25–1732:18; CX-0221; CDX-0013C-83.). In addition, Dr. Almeroth testified that all of the port services are configurable via Arista's EOS software, such as through CLI commands, which Dr. Mir does not dispute. (Tr. (Almeroth) at 1046:9-18, 1047:9–1048:5, 1048:6–1049:4, 1049:5-15; Tr. (Mir) at 1731:25–1732:18; CX-0221 at 87, 835, 848.).

Accordingly, because there is no dispute between Cisco and Arista, Cisco has met its burden by a

⁹⁹ This document, entitled “Arista Networks User Manual,” discusses Arista's switches, their supported features, and switch feature availability on certain switch platforms. (CX-0221 at CSI-ANI-00128383.000044.).

Public Version

preponderance of the evidence that the '668 Accused Products meet limitation iii of claims 1 and 55 of the '668 patent.

- iv. “[executing] a control plane, comprising a plurality of internetworking control plane processes, the control plane processes for providing high-level control and configuration of the ports and the port services”**

Cisco claimed, and Arista, through its expert, Dr. Mir, does not dispute, that all of the '668 Accused Products meet this limitation. (CBr. at 18; RBr. at 24-37.). Dr. Almeroth testified that based on Mr. Holbrook's June 24, 2015 deposition testimony (JX-0026C at 486:17-23) and an Arista white paper entitled, “Arista 7500 Switch Architecture” (CX-0226), all of the '668 Accused Products include control planes having a plurality of internetworking control plane processes. (Tr. (Almeroth) at 1049:16–1051:8; Tr. (Mir) at 1731:25–1732:18; Tr. (Holbrook) at 1795:17-25, 1820:7-10; JX-0026C at 486:17-23; *see also* CX-0221 at 45, 415, 429, 452, 622, 650; CX-0226.). Dr. Almeroth also testified that that the control plane in the '668 Accused Products provides high-level control and configuration of ports and port services via Arista's EOS software. (Tr. (Almeroth) at 1051:1-8; *see also* CX-0221 at 45, 415, 429, 452, 622, 650.). Accordingly, because there is no dispute between Cisco and Arista, Cisco has met its burden by a preponderance of the evidence that the '668 Accused Products meet limitation iv of claims 1 and 55 of the '668 patent.

- v. “[accessing the collection of control plane processes as] a control plane port entity provides access to the collection of control plane processes, so that a set of control plane port services can be applied thereto”**

Cisco claimed, and Arista did not dispute, that all of the '668 Accused Products meet this limitation. (CBr. at 19; RBr. at 24-37.). Dr. Almeroth offered his opinion that based, *inter alia*,

Public Version

on the July 16, 2015 deposition testimony of Dr. Francois Labonte,¹⁰⁰ and Arista's technical documents (CX-0049 at 2; CX-0043 at 3; CX-0054 at 1), [

] which Dr. Mir did not dispute. (Tr. (Almeroth) at 1053:3–1054:23, 1055:16–1056:11; Tr. (Mir) at 1731:25–1732:18; JX-0032C at 78:6-11; CX-0049 at 2; CX-0043 at 3; CX-0054 at 1.). Dr. Almeroth also relied on the August 2, 2015 deposition testimony given by one of Arista's engineers, Mr. Venati, to arrive at his opinion [

(JX-0042C at 61:14-20.).

With regard to the PiP CoPP feature, the weight of the evidence, which includes the consistent testimony of Dr. Almeroth, Mr. Holbrook, and Dr. Labonte, demonstrates that the

[] (Tr. (Almeroth) at 1055:16–1056:11; Tr.

(Holbrook) at 1844:14-24; JX-0032C at 460:14-25).).

Additionally, based on Arista's technical documents describing, for example, Arista's 7050 Series (*see, e.g.*, CX-0082C at 205), Dr. Almeroth testified that [

] (Tr. (Almeroth) at 1026:7-14, 1054:24–1055:15; CX-0035C at 1; CX-0082 at ANI-ITC-944_945-1157679; CX-0132C at 8; *see also* JX-0028C at 44:6-12;

¹⁰⁰ At the time of his testimony, Dr. Francois Labonte ("Dr. Labonte") was a software engineering manager at Arista. (JX-0032C at 78:6-11.). Arista designated Dr. Labonte as a fact witness to provide testimony with regard to the design, development, and operation of the accused products, including but not limited to features such as access control lists and/or control plane protection. (RPSt. at 2.).

JX-0045C at 78:3-25).).

Accordingly, because there is no dispute, Cisco has met its burden by a preponderance of the evidence that the '668 Accused Products meet limitation v of claims 1 and 55 of the '668 patent.

- vi. ***“[operating] the control plane port services operate on packets received from specific, predetermined physical ports and destined to the collection of control plane processes in a way that is independent of the [individual] physical port interfaces [physical port interface configuration] and [port] services applied thereto”***

The center of the dispute with regard to this limitation is whether the CP-ACL and CoPP features enabled in the '668 Accused Products include “control place port services [that] operate on packets received from *specific, predetermined physical ports*” and whether the per-input-port PiP CoPP feature enabled in the '668 Accused Products operate on these packets “in a way that is *independent* of the [individual] physical port interfaces [physical port interface configuration] and [port] services applied thereto.” (JX-0002 at 9:37-41 (emphasis added), 13:30-34 (emphasis added)). Evidence adduced in this Investigation reflects that the '668 Accused Products that have CP-ACL, CoPP, and the non-configurable PiP CoPP features enables on them meet these limitations.

Dr. Almeroth testified that, based on, *inter alia*, an Arista technical document (CX-0130C at 12)¹⁰¹ and the July 16, 2015 and August 1, 2015 deposition testimony of Arista’s engineers,

¹⁰¹ This is a PowerPoint presentation that includes two (2) parts. [

]

Public Version

Dr. Labonte and Mr. Karthikeyan Ramanan,¹⁰² respectively (JX-0032C; JX-0035C), the

[

] (Tr. (Almeroth) at 1067:8–

1070:4, 1073:18–1074:11, 1075:23–1076:14; JX-0032C at 78:6-11; JX-0035C at 146:19–147:5;

CX-0130C at 12; CX-0091C at 4; CX-0054C at 1; CX-0082C at 205; CX-0043C at 8; CX-

0167C.). Significantly, Dr. Mir testified that [

] apply to

“packets received from . . . physical ports,” as required in claims 1 and 55 of the ’668 patent.

(*See, e.g.*, Tr. (Mir) at 1616:14-22, 1625:1–1627:7.).

However, Arista argued that the ’668 Accused Products that have CP-ACL and CoPP enabled, do not meet the “specific, predetermined physical ports” limitation based on two primary grounds. (RBr. at 24-26.). First, Dr. Mir, Arista’s expert, testified that [

] (Tr. (Mir) at 1623:4-18, 1624:21–1625:9, 1631:20–1632:21, 1641:4-15.). Second, Dr.

Mir testified that [

] (Tr. (Mir) at 1623:4-18, 1624:21–1625:9,

1631:20–1632:21, 1641:4-15.).

Arista’s arguments and Dr. Mir’s testimony on which Arista relied are based on a flawed interpretation of the plain and ordinary meaning of “specific, predetermined ports.” Arista’s arguments and Dr. Mir’s testimony seem to suggest that in order to meet this limitation, the

¹⁰² At the time of his testimony, Mr. Karthikeyan Ramanan (“Mr. Ramanan”) was a software engineer at Arista. (JX-0035C at 6:9-10.).

Public Version

accused features must be able to “differentiate” or “specify” the ports from which packets arrive “in advance,” which Arista included as part of its proposed claim construction for this limitation. (RMBR. at 40.). This proposed construction was squarely rejected. (*Markman* Order at 55 (“There is nothing in the plain language of the asserted and unasserted claims . . . to suggest that ‘predetermined’ must mean defined in advance by system administrators.”)). Arista’s arguments also suggest that packets from “specific, predetermined ports” cannot arrive from all ports but rather, must come from a “subset of the total physical ports” which was also part of Arista’s original proposed claim construction, and similarly, rejected. (RMBR. at 40; *Markman* Order at 55 (“There is nothing in the plain language of the asserted and unasserted claims to support the proposed language ‘a subset of the total physical ports[.]’”). Nor is there any support in the ’668 patent for such an interpretation of “specific, predetermined ports.” (*Markman* Order at 56-57.).

The disclosed embodiments do not specify particular ports or limit the ports in any defined way. Dr. Mir acknowledged that the sample set of configuration commands for a control plane port service depicted in Figure 5 of the ’668 patent does not specify particular ports. (Tr. (Mir) at 1767:2–1772:6.). Thus, in order to meet the “specific, predetermined ports” limitation, the ’668 Accused Products incorporating CP-ACL and CoPP features are neither required to “specify” the ports from which packets are received nor must come from a “subset” of all the ports, consistent with the *Markman* Order. (*Markman* Order at 56-57.).

Arista’s argument that Cisco’s and Dr. Almeroth’s interpretation of the plain and ordinary meaning of “specific, predetermined ports” that renders the language superfluous is equally misplaced. (RBR. at 24-25.). As Arista points out, the limitation “specific, predetermined physical ports” was added to claims 1, 19, 37, and 55 by Examiner’s Amendment.

Public Version

(JX-0008 at 99, 106.). However, as the *Markman* Order indicates, the “reasons for adding the amendment are not well developed in the file history.” (*Markman* Order at 58 (citing JX-0008 at 98-99, 106-119).). Thus, without any support in the intrinsic record, it is not proper to import requirements into the meaning of “specific, predetermined ports.” *See Phillips*, 415 F.3d at 1316 (“The construction that stays true to the claim language and most naturally aligns with the patent’s description of the invention will be, in the end, the correct construction.”).

Additionally, Arista contended that the per-input-port PiP CoPP feature does not operate “in a way that is independent of the physical port interfaces,” as recited in claim 1, and does not operate “in a way that is independent of . . . [port] services applied thereto,” as recited in claims 1 and 55. According to Arista: (1) [

] (Tr. (Mir) at 1607:25–1608:8, 1642:8-25, 1643:14–

1647:2.); and (2) [

] (*See, e.g.*, RX-0549C; Tr. (Mir) at 1642:8-25, 1643:14–

1647:2, 1649:20-25.).

Again, Arista appeared to be relying on a flawed interpretation of the plain and ordinary meaning of “independent of” physical port interfaces and services. Arista’s arguments and Dr. Mir’s testimony are based on a construction that requires the control plane port services to “not consider the port that the packet came in on.” (Tr. (Mir) at 1747:20-23.). For instance, Dr. Mir testified to the following:

Q: In order to be – I’m just asking about your understanding of the plain and ordinary meaning of the word “independent.” Can control plane port services that consider the port that the packet came in on be independent under the plain and ordinary meaning of that term?

Public Version

A: If it's independent, it should not have a knowledge of the port.

Q: Okay. So in your understanding of the plain and ordinary meaning of independent is that the word "independent" means without consideration of the port that the packet came in on. Is that fair?

A: Without knowledge of the port number.

(Tr. (Mir) at 1750:25–1751:11.).

Staff also argued that PiP CoPP, which applies "to particular physical port interfaces" cannot satisfy the "independent of" limitation. (SBr. at 28.).

This interpretation directly contradicts the adopted claim construction and the previous *Markman* Order finding that Arista's proposed construction of "independent of," that is, "separate from and without consideration of," was not supported by the plain language of the asserted claims or the '668 patent specification. (*Markman* Order at 61-62.). Moreover, the language "independent of the physical port interfaces and services applied thereto" in independent claim 1 cannot mean that the control plane port services are applied to packets without discriminating the physical ports from which the packets were received, because dependent claim 8 expressly requires such discrimination. (JX-0002 at 10:1-5 ("the control plane port services are implemented as distributed control plane port services, and . . . the distributed control plane port services are applied only to the packets received from the specific, pre-determined physical ports").).

Under the correct interpretation of this claim term, Cisco has met its burden of proof that per-input-port PiP CoPP services are "applied after the control plane packets exit the physical ports and services applied thereto," which satisfies the plain and ordinary meaning of "independent of." (CBr. at 26.). Cisco's interpretation was supported by an Arista engineer, Mr. Karthikeyan Ramanan. Mr. Ramanan testified during his deposition on August 1, 2015, that

Public Version

[
] (JX-0035C at 155:24-156:14.). He testified that
[
] (*Id.* at 156:16-157:4.). He also
testified that [
]
(*Id.* at 157:15-19 [

] This testimonial evidence adduced by Cisco is uncontested,
because Dr. Mir’s non-infringement opinion is based on a flawed construction of the phrase
“independent of.” (Tr. (Mir) at 1608:3-8.). Therefore, Cisco has proven by preponderance of
evidence that per-input-port PiP CoPP satisfies this portion of limitation vi.

The remaining portions of limitation vi were not disputed. For instance, Cisco claimed,
and Arista did not dispute, that [

] (CBr. at 19-20; RBr. at 24-37.). Dr. Almeroth testified, and Dr. Mir agreed, that [

] (Tr. (Almeroth) at 1064:20–1067:7,
1073:3-17, 1075:5-22; Tr. (Mir) at 1733:24–1734:18.). Additionally, Dr. Almeroth testified, and
Dr. Mir did not dispute, that [

] (Tr. (Almeroth) 1073:3-17; Tr. (Mir) at 1733:24–
1734:18.). Accordingly, because there was no dispute, Cisco has met its burden and proven by a

Public Version

preponderance of the evidence that the '668 Accused Products that incorporate CP-ACL, CoPP, and non-configurable and per-input-port PiP CoPP, include the claimed “control plane port services.”

Arista also did not dispute that both the non-configurable and per-input-port PiP CoPP-enabled '668 Accused Products have “control plane port services [that] operate on packets received from specific, predetermined physical ports.” (RPBr. at 98-100; RBr. at 29-37.). Based on [

] (Tr. (Almeroth) at 1075:23–1076:14.). Because there was no dispute, Cisco has met its burden and proven by a preponderance of the evidence that the '668 Accused Products that incorporate CP-ACL, CoPP, and either aspect of PiP CoPP include “specific, predetermined physical ports.”

Arista also does not dispute that the '668 Accused Products incorporating CP-ACL, CoPP, and non-configurable PiP CoPP operate on packets “in a way that is independent of the [individual] physical port interfaces [physical port interface configuration] and [port] services applied thereto.” (RPBr. at 96-98; RBr. at 23-29; Tr. (Almeroth) at 1071:12-18.). Dr. Almeroth testified that based on, for example, [

¹⁰³ At the time of his testimony, Mr. Daniel Imfeld (“Mr. Imfeld”) was a former Arista engineer. (*See, e.g.*, JX-0028C at 16:6-19.).

] (Tr. (Almeroth) at 1070:5–1071:11, 1074:12–1075:4; JX-0028C at 42:16-22, 44:6-12; JX-0035C at 43:6-15, 133:15-24, 157:6-19; JX-0042C at 37:17-21; JX-0032C at 96:4–97:2, 147:4-17; CX-0041C; CX-0043C at ANI-ITC-944_945-0152653; CX-0067C at 7; CX-0222 at 7-9; CX-0091C at ANI-ITC-944_945-1213945.). With regard to [] Dr. Mir testified that this accused feature meets this limitation.

[

]

(Tr. (Mir) at 1753:13–1743:5.). Accordingly, because there is no dispute, Cisco has met its burden and established by a preponderance of the evidence that the '668 Accused Products that incorporate CP-ACL, CoPP, and non-configurable PiP CoPP meet this limitation.

For these reasons, the '668 Accused Products that incorporate the CoPP, CP-ACL, and/or the non-configurable and per-input-port PiP CoPP features infringe claims 1 and 55 of the '668 patent.

b) Claim 2.

- i. A device as in claim 1 wherein the control plane processes are accessible through a control plane port on the internetworking device, such that control plane packets originating at a plurality of physical ports and destined to one of a plurality of control plane processes are first processed through the control plane port, rather than to individual control plane processes.*

Public Version

Cisco claimed that the '668 Accused Products meet the additional limitations set forth in claim 2 of the '668 patent. (CBr. at 27.). Dr. Almeroth testified that based, *inter alia*, on Arista's technical documents (CX-0043C, CX-0082C) and the July 16, 2015 and August 1, 2015 deposition testimonies of Arista engineers, Mr. Imfeld and Dr. Labonte, respectively, [

] (Tr. (Almeroth) at 1079:13–1080:14; JX-0032C at 78:6-11, 96:4-20, 96:23–97:2; JX-0035C at 32:1-20, 32:22–33:12, 43:6-15, 133:15-24, 157:5-19; CX-0074C; CX-0222 at 4-9; CX-0226 at 5.).

In its Pre-Hearing and initial Post-Hearing Briefs, Arista did not assert any non-infringement arguments with respect to this claim other than those discussed for claim 1. (RPBr. at 94-101; RBr. at 24-37.). In its Reply Post-Hearing Brief, Arista improperly raised for the first time that it disputes infringement of the asserted dependent claims. (RRBr. at 17-18.). Under Ground Rules 11.2 and 15.1.1, Arista's assertion is deemed waived. (*See* G.R. 11.2 ("Any contentions not set forth with the level of particularity required herein shall be deemed abandoned or withdrawn."), 15.1.1 ("Any factual or legal issues not addressed in the post-hearing briefs shall be deemed waived.")).

Accordingly, because Arista did not properly assert its non-infringement position in a timely fashion, Cisco has met its burden and demonstrated by a preponderance of the evidence that '668 Accused Products meet the additional limitations recited in claim 2 of the '668 patent.

c) Claim 4.

- i. A device as in claim 3 wherein the control plane port services are applied after a transit packet forwarding decision is made.*

Public Version

Cisco claimed that the '668 Accused Products meet the additional limitation set forth in claim 4. (CBr. at 27.). Relying on, *inter alia*, a 2014 Arista white paper (CX-0226),¹⁰⁴ Dr. Almeroth testified that the '668 Accused Products that [

] (Tr. (Almeroth) at 1080:15–1081:24; CX-0226 at 5.). In addition, Dr. Almeroth opined that based on Arista's technical documents (*see, e.g.*, CX-0074C) and an Arista white paper (CX-0222),¹⁰⁵ [] include “packets destined to the control plane port [that] are identified using information implicit to the packets, or information specified in configuration of the internetworking device,” as recited in claim 3, from which claim 4 depends. (Tr. (Almeroth) at 1081:25–1082:12; CX0074C; CX-0222 at 4-9.).

In its Pre-Hearing and initial Post-Hearing Briefs, Arista did not assert any non-infringement arguments with respect to this claim other than those discussed for claim 1. (RPBr. at 94-101; RBr. at 24-37.). In its Reply Post-Hearing Brief, Arista improperly raised for the first time that it disputes infringement of the asserted dependent claims. (RRBr. at 17-18.). Under Ground Rules 11.2 and 15.1.1, Arista's assertion is deemed waived. (*See* G.R. 11.2, 15.1.1.).

Accordingly, because Arista did not properly assert its non-infringement position in a timely fashion, Cisco has met its burden and proven by a preponderance of the evidence that '668 Accused Products meet the additional limitations recited in claim 4 of the '668 patent.

¹⁰⁴ This document is entitled “Arista 7500 Switch Architecture ('A day in the life of a packet').” (CX-0226.). As the title suggests, the white paper discusses the Arista 7500 Series. (*Id.*).

¹⁰⁵ This document is entitled “Arista 7050X Switch Architecture ('A day in the life of a packet').” (CX-0222.). As the title suggests, the white paper discusses the Arista 7050X Series. (*Id.*).

d) Claim 5.

- i. A device as in claim 3 wherein Layer 2 control packets are identified and forwarded to the control plane port.*

Cisco claimed that the '668 Accused Products meet the additional limitation set forth in claim 5. (CBr. at 27.). Based on Arista's technical documents and the July 16, 2015 deposition testimony from Dr. Labonte, one of Arista's software engineers, Dr. Almeroth testified that all of

[

] (Tr.

(Almeroth) 1082:13–1083:8; JX-0032C at 90:8-10; CX-0043C at 1; CX-0073C at 3; CX-0221 at 1146; *see also* JX-0042C at 69:9-16.).

In its Pre-Hearing and initial Post-Hearing Briefs, Arista did not assert any non-infringement arguments with respect to this claim other than those discussed for claim 1. (RPBr. at 94-101; RBr. at 24-37.). In its Reply Post-Hearing Brief, Arista improperly raised for the first time that it disputes infringement of the asserted dependent claims. (RRBr. at 17-18.). Under Ground Rules 11.2 and 15.1.1, Arista's assertion is deemed waived. (*See* G.R. 11.2, 15.1.1.).

Accordingly, because Arista did not properly assert its non-infringement position in a timely fashion, Cisco has met its burden and proven by a preponderance of the evidence that '668 Accused Products meet the additional limitations recited in claim 5 of the '668 patent.

e) Claim 7.

- i. A device as in claim 1 wherein the control plane processes are distributed across multiple processors.*

Cisco claimed that the "modular" Arista products (including the 7300 and 7500E Series) that have the CoPP, CP-ACL, and/or PiP CoPP features enabled meet the additional limitation set forth in claim 7. (CBr. at 28.). Dr. Almeroth testified that based, *inter alia*, on an Arista

white paper (CX-0226), [

] (Tr. (Almeroth) at 1083:9²

1084:18; CX-0226 at 2, 4; *see also* JX-0032C at 132:5–133:24.).

In its Pre-Hearing and initial Post-Hearing Briefs, Arista did not assert any non-infringement arguments with respect to this claim other than those discussed for claim 1. (RPBr. at 94-101; RBr. at 24-37.). In its Reply Post-Hearing Brief, Arista improperly raised for the first time that it disputes infringement of the asserted dependent claims. (RRBr. at 17-18.). Under Ground Rules 11.2 and 15.1.1, Arista's assertion is deemed waived. (*See* G.R. 11.2, 15.1.1.).

Accordingly, because Arista did not properly assert its non-infringement position in a timely fashion, Cisco has met its burden and proven by a preponderance of the evidence that '668 Accused Products meet the additional limitations recited in claim 7 of the '668 patent.

f) Claim 8.

- i. A device as in claim 1 wherein the control plane port services are implemented as an aggregate control plane function applied to packets received from multiple physical ports on the internetworking device.*

Cisco claimed that the '668 Accused Products that include CoPP and/or CP-ACL meet the additional limitation set forth in claim 8. (CBr. at 28.). Relying on, *inter alia*, an Arista white paper (CX-0222) and Arista's technical documents (*see, e.g.*, CX-0043C), Dr. Almeroth testified that [

¹⁰⁶ *See supra* Section VII.C.1.

] (Tr.

(Almeroth) at 1084:19–1085:17; CX-0043C at 3; *see also* CX-0054C at 1; CX-0082C at ANI-ITC-944_945-1157679; CX-0088C at 16, 45; CX-0222 at 2.).

In its Pre-Hearing and initial Post-Hearing Briefs, Arista did not assert any non-infringement arguments with respect to this claim other than those discussed for claim 1. (RPBr. at 94-101; RBr. at 24-37.). In its Reply Post-Hearing Brief, Arista improperly raised for the first time that it disputes infringement of the asserted dependent claims. (RRBr. at 17-18.). Under Ground Rules 11.2 and 15.1.1, Arista’s assertion is deemed waived. (*See* G.R. 11.2, 15.1.1.).

Accordingly, because Arista did not properly assert its non-infringement position in a timely fashion, Cisco has met its burden and proven by a preponderance of the evidence that ’668 Accused Products meet the additional limitations recited in claim 8 of the ’668 patent.

g) Claim 10.

- i. A device as in claim 1 wherein the control plane port services are implemented as distributed control plane port services, and wherein the distributed control plane port services are applied only to the packets received from the specific, pre-determined physical ports.*

Cisco claimed that the ’668 Accused Products having multiple packet processors (the [Series Switches) that include CoPP and/or PiP CoPP meet the additional limitations set forth in claim 10. (CBr. at 28.). Dr. Almeroth testified that these products [

] (Tr. (Almeroth) at 1085:18–1086:15; CX-0130C at 12; *see also* JX-

0026C at 513:19–514:8; JX-0032C at 33:23–34:18, 50:14-25, 51:1-3, 51:18-21, 134:14–135:10; JX-0035C at 146:19–147:5; CX-0049C at 2-3; CX-0053C at 4; CX-0087C at 1; CX-0091C at 3, 7.).

In its Pre-Hearing and initial Post-Hearing Briefs, Arista did not assert any non-infringement arguments with respect to this claim other than those discussed for claim 1. (RPBr. at 94-101; RBr. at 24-37.). In its Reply Post-Hearing Brief, Arista improperly raised for the first time that it disputes infringement of the asserted dependent claims. (RRBr. at 17-18.). Under Ground Rules 11.2 and 15.1.1, Arista’s assertion is deemed waived. (See G.R. 11.2, 15.1.1.).

Accordingly, because Arista did not properly assert its non-infringement position in a timely fashion, Cisco has met its burden and proven by a preponderance of the evidence that ’668 Accused Products meet the additional limitations recited in claim 10 of the ’668 patent.

h) Claim 13.

i. A device as in claim 10 wherein one or more distributed switch engines deliver packets to the control plane port.

Cisco claimed that the ’668 Accused Products having multiple packet processors (the [] Series Switches) that include CoPP, CP-ACL, and/or PiP CoPP meet the additional limitations set forth in claim 13. (CBr. at 28-29.). Dr. Almeroth testified that these products [

] (Tr. (Almeroth) at 1086:16–1087:7; CX-0088C at ANI-ITC-944_945-1194111; *see also* JX-0026C at 513:19–514:8; JX-0032C at 33:32 –34:18, 50:14-25, 51:1-3, 51:18-21, 134:14–135:10; JX-0035C at 146:19–147:1, 147:2-5; CX-0049C at 2-3; CX-0053C at 4; CX-0087C at 1; CX-0091C at 3, 7; CX-0130C at 12.).

Public Version

In its Pre-Hearing and initial Post-Hearing Briefs, Arista did not assert any non-infringement arguments with respect to this claim other than those discussed for claim 1. (RPBr. at 94-101; RBr. at 24-37.). In its Reply Post-Hearing Brief, Arista improperly raised for the first time that it disputes infringement of the asserted dependent claims. (RRBr. at 17-18.). Under Ground Rules 11.2 and 15.1.1, Arista's assertion is deemed waived. (See G.R. 11.2, 15.1.1.).

Accordingly, because Arista did not properly assert its non-infringement position in a timely fashion, Cisco has met its burden by a preponderance of the evidence that '668 Accused Products meet the additional limitations recited in claim 13 of the '668 patent.

i) Claim 18.

- i. A device as in claim 1 where in control plane port services are controlled and configured as unique entity, separate from physical port services.*

Cisco claimed that the '668 Accused Products meet the additional limitations set forth in claim 18. (CBr. at 29.). Dr. Almeroth testified that based, *inter alia*, on Arista's technical documents (*see, e.g.*, CX-0221) and the August 1, 2015 deposition testimony of one of Arista's engineers, Mr. Ramanan (JX-0035C), [

] (Tr. (Almeroth) at 1087:8–1088:8;

JX-0035C at 82:13-21; CX-0221 at 418, 622, 847-48; *see also* JX-0026C at 505:4–506:4, 508:4-11; JX-0028C at 36:12-21, 41:6-21, 42:4-22; JX-0043C at 28:8-12, 28:15-16; CX-0045C at 1; CX-0082C at ANI-ITC-944_945-1157679.).

In its Pre-Hearing and initial Post-Hearing Briefs, Arista did not assert any non-infringement arguments with respect to this claim other than those discussed for claim 1. (RPBr.

at 94-101; RBr. at 24-37.). In its Reply Post-Hearing Brief, Arista improperly raised for the first time that it disputes infringement of the asserted dependent claims. (RRBr. at 17-18.). Under Ground Rules 11.2 and 15.1.1, Arista's assertion is deemed waived. (See G.R. 11.2, 15.1.1.).

Accordingly, because Arista did not properly assert its non-infringement position in a timely fashion, Cisco has met its burden and proven by a preponderance of the evidence that '668 Accused Products meet the additional limitations recited in claim 18 of the '668 patent.

j) Claim 56.

- i. A medium as in claim 55 wherein the control plane port processes packets originating at a plurality of physical ports, the method additionally comprising: passing packets through the control plane port, rather than directly from the physical ports to individual control plane processes.*

Cisco claimed that the '668 Accused Products meet the additional limitations set forth in claim 56. (CBr. at 27.). Dr. Almeroth testified that the '668 Accused Products that incorporate the CoPP, CP-ACL, and/or PiP CoPP features [

] (Tr. (Almeroth)

at 1092:2-17; CX-0043 at 8.).

In its Pre-Hearing and initial Post-Hearing Briefs, Arista did not assert any non-infringement arguments with respect to this claim other than those discussed for claim 1. (RPBr. at 94-101; RBr. at 24-37.). In its Reply Post-Hearing Brief, Arista improperly raised for the first time that it disputes infringement of the asserted dependent claims. (RRBr. at 17-18.). Under Ground Rules 11.2 and 15.1.1, Arista's assertion is deemed waived. (See G.R. 11.2, 15.1.1.).

Accordingly, because Arista did not properly assert its non-infringement position in a timely fashion, Cisco has met its burden by a preponderance of the evidence that '668 Accused Products meet the additional limitations recited in claim 56 of the '668 patent.

k) Claim 64.

- i. *A medium as in claim 55 additionally comprising: applying distributed control plane port services only to the packets received from the specific, pre-determined physical ports.***

Cisco claimed that the '668 Accused Products having multiple packet processors (the [] Series Switches) that include CoPP and/or PiP CoPP meet the additional limitations set forth in claim 10. (CBr. at 28.). Dr. Almeroth testified that these products [

] (Tr. (Almeroth) at 1093:22–1095:4; JX-0026C at 513:19–514:8; JX-0032C at 33:23–34:18, 50:14–25, 51:1–3, 51:18–21, 134:14–135:10; JX-0035C at 146:19–147:5; CX-0049C at 2–3; CX-0053C at 4; CX-0087C at 1; CX-0091C at 3, 7; CX-0130C at 12).).

In its Pre-Hearing and initial Post-Hearing Briefs, Arista did not assert any non-infringement arguments with respect to this claim other than those discussed for claim 1. (RPBr. at 94–101; RBr. at 24–37.). In its Reply Post-Hearing Brief, Arista improperly raised for the first time that it disputes infringement of the asserted dependent claims. (RRBr. at 17–18.). Under Ground Rules 11.2 and 15.1.1, Arista's assertion is deemed waived. (*See* G.R. 11.2, 15.1.1.).

Accordingly, because Arista did not properly assert its non-infringement position in a timely fashion, Cisco has met its burden by a preponderance of the evidence that '668 Accused Products meet the additional limitations recited in claim 64 of the '668 patent.

l) Direct Infringement of the '668 Patent in the United States

Public Version

Cisco has proven by a preponderance of the evidence that Arista's customers use the '668 Accused Products in the United States, as evidenced by Arista customer deposition testimony from July 20, 2015, and [

] (Tr. (Almeroth) at 1098:15–1100:23; JX-0036C at 101:4–102:8; CPX-0054C; CPX-0055C; CPX-0063C; CPX-0064C; CPX-0065C; CPX-0069C; CPX-0072C; CPX-0073C; CPX-0075C.). [

]

Arista argued that there cannot be direct infringement of the '668 patent at the time of importation because the EOS software (including CoPP and CP-ACL) is not loaded on the Blank Switches and Imported Components at the time of importation. (*Id.* (citing Tr. (Almeroth) at 1029:24–1030:8, 1091:14–1092:1).). To the contrary, the record evidence shows, and Arista actually acknowledged through Mr. Metivier's testimony, that the accused devices included the EOS software at the time of importation when the Complaint giving rise to this Investigation was filed. (Tr. (Metivier) at 2073:19–2075:15, 2087:9-12.). For instance, Mr. Metivier stated that Arista [

] alone is sufficient to establish direct infringement at the time of importation. *See, e.g., Certain Absorbent Garments*, Inv. No. 337-TA-508, Order No. 16, 2004 WL 2251882, at *2 (Aug. 20, 2004) (noting that “a complainant need only establish the importation of a *single* accused product to satisfy the importation requirement”) (emphasis added).

3. Indirect Infringement

Cisco has accused the '668 Accused Products of indirectly infringing claims 1, 2, 4, 5, 7,

Public Version

8, 10, 13, 18, 56, and 64 of the '668 patent. (See CBr. at Attach. B.).

a) Induced Infringement

i. Direct Infringement

The preponderance of the evidence supports a finding that the '668 Accused Products loaded with EOS directly infringe the asserted claims at the time of importation. At issue is whether there is induced infringement of the '668 Accused Products loaded with EOS after importation because Arista was aware of the '668 patent, induced direct infringement, and knew that its actions would induce actual direct infringement. See *Suprema, Inc. v. Int'l Trade Comm'n*, 796 F.3d 1338 (Fed. Cir. 2015); *Commil USA*, 720 F.3d at 1367.

ii. Specific Intent to Cause Infringement

The weight of the evidence demonstrates that Arista had a specific intent to induce infringement, as evidenced by the change in its importation practices soon after Cisco filed the Complaint in this Investigation. See, e.g., *Commil USA, LLC v. Cisco Sys., Inc.*, 135 S. Ct. at 1928 (noting that to show that a defendant actively induced infringement requires intent to “bring about the desired result”) (quoting *Global-Tech Appliances, Inc. v. SEB S.A.*, 131 S. Ct. 2060, 2065 (2011)). Mr. Metivier testified [

] (Tr. (Metivier) at 2072:23–

2073:2, 2081:11-21.). He testified that [

] (Tr. (Metivier) at 2082:22–2083:5,

2084:7-10, 2093:21–2094:1.). Mr. Metivier admitted [

] (Tr. (Metivier) at 2083:22–2084:1.). Mr. Metivier [

] (Tr. (Metivier) at

Public Version

2084:2-19). [] (Tr. (Metivier) at 2084:2-4, 2084:11–2085:1, 2091:20–2092:9, 2093:8-23, 2093:21–2094:3).¹⁰⁷ The timing of this change, the products affected, and the lack of any business reasons lead to a conclusion, and a finding in this Investigation, that Arista had a specific intent to induce infringement. *See, e.g., SynQor, Inc. v. Artesyn Techs., Inc.*, 709 F.3d 1365, 1384-85 (Fed. Cir. 2013) (affirming the lower court’s finding that appellant’s “non-importation agreement,” which prevented infringing converters from being incorporated into products shipped to the U.S., revealed that appellant knew that direct infringement would occur and planned for the liability that it would incur by inducing the direct infringement).

The weight of the evidence also establishes that [] (See, e.g., Tr. (Sadana) at 2143:6-16, 2143:23–2144:5, 2144:16-22, 2146:4-6; JX-0041C at 58:1-12, CX-0134 []; CX-0158C [

] (See, e.g., CX-0158X [

¹⁰⁷ In Investigation No. 337-TA-944, which also involves the same parties, Arista made a similar argument that the accused products did not infringe based on this change in importation procedures. The Commission affirmed the Administrative Law Judge’s Initial Determination finding that this change “evinces knowledge and an intent to infringe under the relevant standards for contributory and induced infringement.” *Certain Network Devices, Related Software and Components Thereof (I)*, Inv. No. 337-TA-944, Comm’n Op. at 15, 46 (June 23, 2016).

Public Version

] CX-0157C [

]; CX-0154C [

]; CX-0149C [

]; CX-0161C [

]; CX-0155C [

] (*See, e.g.,*

CX-0134C [

] Mr. Duda testified [

] (*See, e.g.,* JX-0025C at 482:24–483:5. Arista’s CEO, Ms. Ullal, testified that [

] (JX-0041C at 56:14–59:3.). Mr. Sadana also testified

that [

¹⁰⁸ At the time of her testimony, Ms. Jayshree Ullal (“Ms. Ullal”) was the Chief Executive Officer of Arista. (JX-0041C at 11:24–12:2.).

¹⁰⁹ At the time of his testimony, Mr. Richard Whitney (“Mr. Whitney”) was a Federal Systems Engineering Team Lead at Arista. (CX-0134C.).

¹¹⁰ At the time of his testimony, Mr. Douglas Gourlay (“Mr. Gourlay”) was the Vice President of Arista. (CX-0161C.).

]

(Tr. (Sadana) at 2140:11-14, 2140:18-21.).

Additionally, [

] (CX-0158C; *see also* JX-0025C at 215:18-19, 219:3-6.).

Additionally, there is evidence that reflects that Arista willfully blinded itself to Cisco's patents and Arista's infringement. *See Global-Tech*, 131 S. Ct. at 2070 (stating that the two basic requirements for a showing of willful blindness include: (1) the defendant's subjective belief that there is a high probability of infringement; and (2) the defendant's deliberate actions to avoid learning of its infringement). The fact that Arista copied certain patented features of Cisco's products and marketed those features to its customers proves that Arista subjectively believed in the high probability of its infringement. (*See, e.g.*, JX-0025C at 481:2-482:16, 482:24-483:5; Tr. (Sadana) at 2140:11-14, 2140:18-21; CX-0158C, CX-0157C, CX-0134C; CX-0154C; CX-0149C; CX-0161C; CX-0155C.).

Cisco has also provided evidence that Arista took deliberate steps to avoid learning of its infringing conduct. For example, [

] (*See, e.g.*, Tr. (Sadana) at 2140:4-11; JX-0037C at 1-17.). [

] (JX-0037C at 221:9-23.).

Mr. Duda and Ms. Ullal testified that [

] (JX-0025C at 166:18-21; JX-0041 at 41:8-14.). In addition, according to

Mr. Duda, [

] (JX-0025C at 159:2–160:3.). Thus, the evidence supports a finding that Arista willfully blinded itself to Cisco’s patents and its infringing actions.

Certain evidence also proves that Arista had knowledge of the asserted patents, including the ’668 patent, by at least December 4, 2014 (CX-0727C at 47-48; *see also* EDIS Doc. ID No. 551422 (Answer) (admitting that Arista was served a copy of the District Court Complaint on Dec. 14, 2014 and that it alleges infringement of the ’668 patent). *Global-Tech*, 131 S. Ct. at 2067-68 (noting that knowledge of the patent is needed). Thus, the weight of the evidence supports a finding that Arista had knowledge of the ’668 patent for purposes of induced and contributory infringement.

iii. Active Inducement to Infringe the ’668 Patent

Evidence establishes that Arista induces infringement by knowingly encouraging, instructing, and enabling third parties to infringe the asserted claims of the ’668 patent, at least with respect to the CoPP and CP-ACL features. (*See, e.g.*, Tr. (Almeroth) at 1095:19–1096:19; JX-0036C at 101:10-14, 102:1-8; CDX-0013C-175, 177, 179, 181.). For example, an Arista user manual, dated October 4, 2014, instructs and describes to its users how to use control plane ACLs. (Tr. (Almeroth) at 1095:19–1096:19; CX-0221 at CSI-ANI-00128383.000621; CDX-0013C at 175.). There is also evidence that Arista engineers communicated with customers with regard to the functionality of CoPP, which included demonstrating the feature to them. (*See,*

e.g., CX-0119C; JX-0029C at 28:25–29:3, 29:17-21, 29:23-24; CDX-0013C at 177.). For example, [

] (CX-0119C; *see also* JX-0029C at 28:25–29:3, 29:17–29:21, 29:23–29:24.¹¹¹).

Arista’s sales and promotion of the imported hardware components, e.g., processor, memory, CPU card, chassis, switch card, and fan modules, also induce infringement of the ’668 patent because these components are designed to run the EOS software, which contain the infringing functionality. (*See, e.g.*, Tr. (Sadana) at 2133:23–2134:5, 2135:17–2136:9, 2162:3-15.).

For these reasons, the weight of evidence proves that Arista is liable for inducing infringement of the ’668 patent.

b) Contributory Infringement

Evidence establishes that Arista contributorily infringes the ’668 patent. The components implicated in contributory infringement of the ’668 patent are the ’668 Accused Products with EOS, which is a material part of the invention with no substantial non-infringing use. (*See, e.g.*, Tr. (Sadana) at 2133:23–2134; Tr. (Metivier) at 2079:4–2081:4; Tr. (Almeroth) at 1097:22–1098:8; JX-0045C at 105:5-11; JX-0025C at 204:23–205:8, 206:17–207:2; JX-0032C at 21:9–23:3; JX-0048C at 84:25–85:4.). Arista’s contention that the Blank Switches are now imported without EOS does not absolve Arista of its contributory infringement liability. (Tr. (Metivier) at 2082:22–2083:5, 2084:7-10, 2093:21–2094:1.). With regard to just the switch hardware, all of

¹¹¹ Mr. Pradeep Jothimani, an Arista systems test and proof-of-concept engineer, was deposed on August 4, 2015. (JX-0029C.). Mr. Jothimani testified that his “role is usually pre-sales. So when the customer decides to buy a product, they want us to do some testing and make sure that it fits all the needs of the customer. So typically, it can be on-site or sometimes it’s also remote. So we do a demonstration of all the features and the performance that the customer has requested for, which comes in the form of a test plan.” (*Id.* at 9:5-15.).

Public Version

the asserted claims of the '668 patent require an “internetworking device,” “physical ports,” and “physical port interfaces,” which are integral parts of the accused products. (Tr. (Mir) at 1731:25–1732:18, 1732:24–1733:3, 1734:12–18; Tr. (Almeroth) at 1044:6–1046:8.). As a consequence, the switch hardware, including all the individual components, such as the processor, memory, CPU card, chassis, switch card, and fan modules, is a material part of the invention claimed in the '668 patent.

The Arista switch hardware has no substantial non-infringing uses because it is designed for and used exclusively with EOS. (*See, e.g.*, Tr. (Sadana) at 2133:23–2134; Tr. (Metivier) at 2079:4–2081:4; Tr. (Almeroth) at 1097:22–1098:8; JX-0045C at 105:5–11; JX-0025C at 204:23–205:8, 206:17–207:2; JX-0032C at 21:9–23:3; JX-0048C at 84:25–85:4.). For instance, Mr. Metivier testified that:

[

]

(Tr. (Metivier) at 2079:7–2080:13.). Moreover, Mr. Sadana testified that the accused CoPP and CP-ACL features are [

] (Tr. (Sadana) at 2154:7-12, 2154:18-23.).

The imported hardware components, e.g., processor, memory, CPU card, chassis, switch card, and fan modules, also contribute to infringement of the '668 patent because they are imported only to be incorporated into a finished Arista switch and, ultimately, used to run EOS software containing the infringing functionality, and lack any substantial non-infringing uses.

(*See, e.g.*, Tr. (Sadana) at 2135:17–2136:9, 2162:3-15; Tr. (Metivier) at 2080:4-13; JX-0025C at 204:23–205:8.). For example, Mr. Sadana testified:

[

]

Public Version

(Tr. (Sadana) at 2133:23–2134:5 (emphases added)).

The weight of the evidence also supports a finding that by receiving service of the Complaint, Arista had the requisite knowledge for contributory infringement. *Certain Television Sets, Television Receivers, Television Tuners, and Components Thereof*, Inv. No. 337-TA-910, Comm’n Opinion at 41-43 (public version dated Oct. 30, 2015) (Commission held that “[i]n the context of section 337, we concluded that service of a section 337 Complaint can be adequate to provide knowledge of the asserted patents” that is required to prove contributory infringement under 35 U.S.C. § 271(c)). This requirement is also further met by Arista’s making and selling the accused products “which are only adapted to be used in a patented combination will be presumed to intend the natural consequences of [its] acts; [it] will be presumed to intend that they shall be used in the combination of the patent.” *Certain Semiconductor Chips with Minimized Chip Package Size and Prods. Containing Same*, Inv. No. 337-TA-605, 2009 WL 8144934, at *28, Comm’n Determination (June 3, 2009) (quoting *Metro-Goldwyn Mayer Studios, Inc. v. Grokster, Ltd.*, 545 U.S. 913 (2005)), *aff’d*, *Spansion, Inc. v. Int’l Trade Comm’n*, 629 F.3d 1331, 1355 (Fed. Cir. 2010)).

The weight of the adduced evidence proves that Arista is liable for contributing to the infringement of the ’668 patent.

c) Conclusion

For the reasons discussed above in Sections VII.C.3.a and VII.C.3.b, Arista indirectly infringes the ’668 patent.

D. Technical Prong¹¹²

Cisco has proven by a preponderance of the evidence that its products practice the '668 patent. Cisco identified three series of products as practicing claims 1, 2, 4, 5, 7, 8, 10, 13, and 18 of the '668 patent: (1) Cisco 12000 Series Routers; (2) Nexus 7000 Series Switches; and (3) Catalyst 6500 Series Switches (collectively, "'668 DI Products"), which run Cisco's IOS or NX-OS operating systems and incorporate Cisco's Control Plane Policing ("Cisco's CoPP") feature. (CBr. at 35 (citing Tr. (Almeroth) at 1101:8-22, 1019:2-15; Tr. (Keohane) at 934:22-935:5).). The only dispute centers on whether the '668 DI Products include control plane port services that operate on packets received from "specific, predetermined physical ports" as required by element d.ii of independent claim 1. (RBr. at 41.). Arista did not dispute that the '668 DI Products practice all the other elements of independent claim 1 and the additional elements of dependent claims 2, 4-5, 7-8, 10, 13, and 18. (*Id.*).

A Cisco document titled "Infrastructure Protection on Cisco IOS Software-Based Platforms" ("Infrastructure Protection"), with a copyright date of 2006, discloses that "Distributed CoPP provides two layers of control: [1] Distributed Control Plane Services at the line card level [and] [2] Aggregated Control Plane Services at the RP level." (CX-0218 at 24-25.). Figure 4 of this document illustrating Distributed CoPP is shown below next to Figure 2 of the '668 patent illustrating a distributed control plane services implementation.

¹¹² For a discussion of the legal framework of the DI technical prong, *see supra* Section V.D.1.

Infrastructure Protection, Figure 4

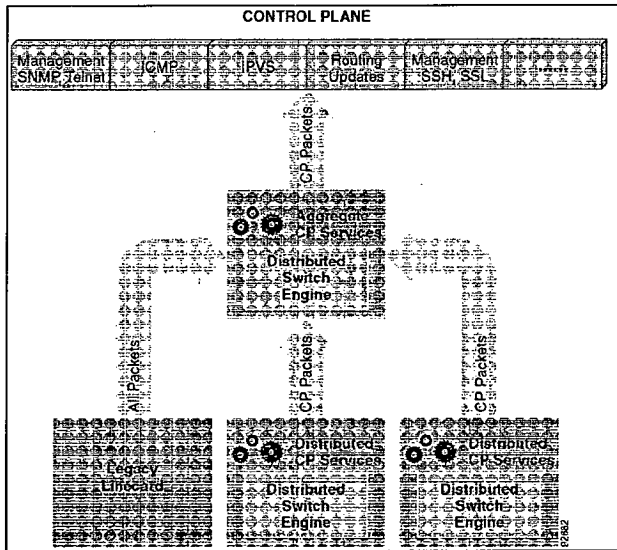

(CX-0218 at Fig. 4)

'668 patent, Figure 2

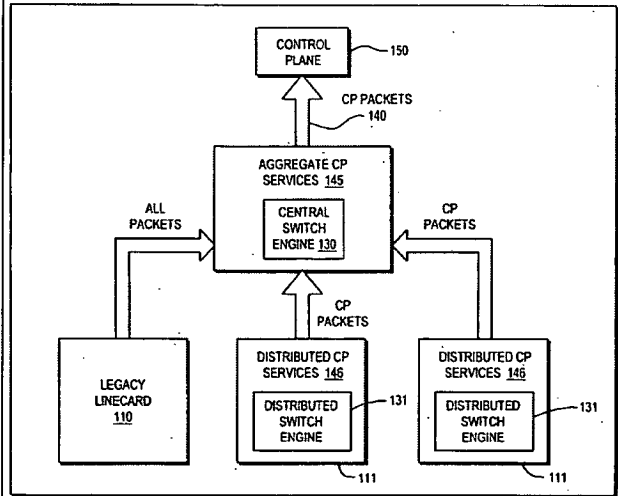

(JX-0002 at Fig. 2)

The Cisco document explains that Distributed CoPP allows Distributed Control Plane Services to be applied on a “per line card” basis to only the packets arriving from certain line card interfaces. (CX-0218 at 24-25.). Additionally, Aggregate Control Plane Services are applied to “all control packets arriving from all router interfaces.” (*Id.* at 24.). Dr. Almeroth, Cisco’s expert, offered an opinion during the hearing that both the Distributed Control Plane Services and Aggregate Control Plane Services satisfy the “specific, predetermined physical port” limitation of claim 1. He testified that the Distributed Control Plane Services are applied to specific, predetermined ports on the respective line cards and the Aggregate Control Plane Services are applied to all of the specific, predetermined ports on the device. (Tr. (Almeroth) at 1113:1-16.).

A document titled “CoPP on Nexus 7000 Series Switches” by Viral Bhutta, a Cisco engineer, and dated September 4, 2014, discloses:

Traffic that hits the CPU on the Supervisor module can come in through four paths:

1. Inband interfaces (front panel port) for traffic sent by line cards.

Public Version

2. Management Interface (mgmtO) used for management traffic.
3. Control and Monitoring Processor (CMP) interface used for the console.
4. Switched Ethernet Out Band Channel (EOBC) to control the line cards from the Supervisor module and exchange status messages.

Only the traffic sent through the Inband interface is subject to CoPP, because this is the only traffic that reaches the Supervisor module through the forwarding engines (FEs) on the line cards.

(CX-0203 at 1-2.). Dr. Almeroth, Cisco's expert, testified during the hearing that this document describes four paths from which traffic can come to the CPU and specifies that only the traffic from the inband interfaces is subject to CoPP. (Tr. (Almeroth) at 1112:9-22.). In his opinion, the inband interfaces satisfies the "specified, predetermined physical ports" limitation of claim 1. (*Id.*).

Dr. Mir, Arista's expert, did not testify with regard to the '668 DI Products during the hearing. Arista's initial post-hearing brief devotes a mere seven (7) lines, and Arista's reply post-hearing brief, a mere five (5) lines, to dispute Cisco's DI contentions. (RBr. at 41; RRBr. at 18.). Specifically, Arista argued that Cisco failed to establish that the '668 DI Products apply control plane port services to packets received from "specific, predetermined physical ports." (RBr. at 41.). Arista contended that "every line card in Cisco's Alleged DI apply distributed control plane port services to packets generally, and not from specific ports connected to the line card." (*Id.* (citing RX-257 at 10; CX-0203 at 1-3).). It appears that Arista's argument is based on the same misunderstanding of the claim language "specific, predetermined" that formed the basis of Arista's non-infringement arguments. As discussed above with regard to infringement (*see* Section VII.C.2.a.vi), Arista's position that "specific, predetermined" requires a "subset" of the ports and that the DI products must "specify" the ports was rejected more than a year ago during this Investigation. (*See Markman* Order at 53, 55.). The evidence that Cisco has

provided proves that the '668 DI Products are designed to apply control plane port services from physical ports.

For the reasons discussed above, the '668 DI Products satisfy the “specific, predetermined” limitation of claim 1. Since this limitation is the only disputed issue, Cisco has proven that the '668 DI Products practice claims 1-2, 4-5, 7-8, 10, 13, and 18 of the '668 patent and thus meet the technical prong of the domestic industry requirement for the '668 patent.

E. Validity

Arista claimed that the asserted claims of the '668 patent are invalid as anticipated and obvious in view of certain prior art references. As discussed in more detail below, the references neither anticipate nor render obvious the asserted claims of the '668 patent.

Arista failed to meet its burden and establish that the manual from Juniper Networks, Inc. (“Juniper”), entitled “Junos Internet Software Configuration Guide, Interfaces, Class of Service, and Firewalls, Release 5.0” (“JUNOS Guide”) is prior art to the '668 patent. The other references on which Arista relied do not teach physical ports that are “configurable by control plane processes” and “port services . . . defined by control plane configurations.”

In its Pre-Hearing Brief, Arista claimed that the '668 patent is invalid because Cisco allegedly disclosed the claimed technology to UUNet in 2000, more than one year before the effective filing date of the '668 patent, which is November 27, 2002, and that UUNet used the technology without any indication of confidentiality. (RPBr. at 116.). However, Arista did not include this assertion in its Initial Post-Hearing Brief. Under Ground Rule 15.1.1, Arista’s assertion is deemed waived. (*See* G.R. 15.1.1 (“Any factual or legal issues not addressed in the post-hearing briefs shall be deemed waived.”)).

In its Initial Post-Hearing Brief, Arista improperly raises for the first time that '668 patent

should not be awarded a priority date earlier than the '668 patent's November 27, 2002 filing date. (RBr. at 54.). Under Ground Rule 11.2, Arista's assertion is deemed abandoned or withdrawn. (*See* G.R. 11.2.).

1. Anticipation

a) JUNOS Guide

i. Prior Art Status

Arista has not clearly and convincingly proven that the JUNOS Guide anticipates claims 1, 2, 4, 5, 8, 18, and 56 of the '668 patent. As an initial matter, the evidence does not sufficiently demonstrate that the JUNOS Guide was publicly available in August 2001 or before December 2002. (RX-0896.). In support of its contention that the reference was available publicly, Arista relied on: (1) the date on the document itself; and (2) a declaration of Mr. Jerry Isaac on behalf of Juniper Networks, Inc. ("Juniper Declaration"). (*Id.*; RX-1362C.). Arista's reliance on this evidence is flawed for a number of reasons. First, the copyright date printed on the document does not prove that it was publicly available as a matter of law. *See, e.g., CNET Networks, Inc. v. Etilize, Inc.*, 584 F. Supp. 2d 1260, 1273-74 (N.D. Cal. 2008) (holding "a 2001 copyright date does not prove the Liason CE User Guide was publicly accessible prior to April 10, 2001"); *Standard Innovation Corp. v. LELO, Inc.*, IPR2014-00148 (Apr. 23, 2015) (rejecting the use of a copyright date to show the publication date of an alleged prior art reference). Second, the Juniper Declaration does not certify unequivocally that this particular document, that is, the JUNOS Guide, was actively made available to the public before December 2002.¹¹³ On behalf of Juniper, Mr. Isaac simply stated that the guide was:

¹¹³ U.S. Application No. 10/307,154, from which the '668 patent issued, was filed on November 27, 2002. (*See* JX-0002.).

Public Version

dated prior to December 2002, was made at or near the time that is listed on the document, was kept in the course of regularly conducted business activity of Juniper, and it was the regular practice of Juniper to make and maintain such records as part of its regularly conducted business activity.

(RX-1362C (Juniper Decl.) at ¶ 5.). There is no mention whether the JUNOS Guide was made publicly available on or around that date. That the document was “dated prior to December 2002” does not clearly and convincingly establish that it was publicly available before then.

Arista has not provided any corroborating evidence that the JUNOS Guide was publicly available. *See, e.g., In re Enhanced Sec. Research, LLC*, 739 F.3d 1347, 1354-55 (Fed. Cir. 2014) (concluding that software manual was prior art based on manual’s inscription date combined with a declaration from the CEO of the software company); *Certain Semiconductor Chips and Prods. Containing Same*, Inv. No. 377-TA-753, Initial Determination at 105 (Mar. 2, 2012) (finding public availability where specification with 1990 copyright date was incorporated by reference into other, publicly available documents); *Certain Silicon Microphone Packages and Prods. Containing the Same*, Inv. No. 337-TA-695, Initial Determination, 2010 WL 5199618, at *66 (concluding that copyright date corroborated by catalog listing from the U.S. Copyright Office was sufficient to show public availability).

Moreover, Arista relied on testimony provided by Dr. Mir that manuals like the JUNOS Guide would be made publicly available within a week, and at most a month from the date on the document. (Tr. (Mir) at 1669:6–1670:19.). However, Dr. Mir’s testimony at the hearing was held to exceed the scope of his expert report (and knowledge) and stricken for the reasons discussed in Section I.C.2.a.ii. (*See* Tr. (Mir) at 1669:6–1670:19; RRB., App. B (Mir Expert Report) at ¶ 337.).

Additionally, in its Pre-Hearing Brief, Arista failed to set forth the contention that the

Public Version

JUNOS Guide is publicly available and thus prior art. (RPBr. at 104-16.). Under Ground Rule 11.2, “[a]ny contentions not set forth with the level of particularity required herein shall be deemed abandoned or withdrawn.” Accordingly, Arista’s assertions that the JUNOS Guide anticipates claims 1, 2, 4, 5, 8, 18, and 56 of the ’668 patent are deemed abandoned or withdrawn. (*See* G.R. 11.2.).

For these reasons, Arista has not proven by clear and convincing evidence that the JUNOS Guide was publicly available in August 2001 and that the reference is a prior art publication under 35 U.S.C. § 102(b).

ii. Claim 1, 2, 4, 5, 8, 18, and 56

Since Arista has not proven by clear and convincing evidence that the JUNOS Guide is prior art to the ’668 patent, the JUNOS Guide does not anticipate claims 1, 2, 4, 8, 18, and 56.

b) Amara

Arista claimed that U.S. Patent No. 6,674,743 to Amara et al. (“Amara”) anticipates claims 1, 2, 4, 5, 8, 18, and 56 of the ’668 patent. (RBr. at 48; RX-0447.). Amara issued on January 6, 2004 from U.S. Patent Application No. 09/475,855, filed on December 30, 1999. (RX-0447.). Arista asserts that Amara is prior art to the ’668 patent under 35 U.S.C. § 102(a). (RPBr. at 105.).

i. Claims 1 and 55

Amara describes a packet-forwarding device, such as a router or a remote access server, that provides policy-based services for internal applications. (*See, e.g.*, RX-0447 at 1:10-12; *see also id.* at Abstract.). Arista has not clearly and convincingly proven that Amara discloses each and every limitation recited in claims 1 and 55. In particular, the Amara reference fails to disclose physical ports being “configurable by control plane processes” and “port services . . .

defined by control plane configurations.”¹¹⁴

Nonetheless, Arista argued that Amara discloses “a plurality of physical network interface ports . . . the ports being configurable by control plane processes.” (RBr. at 49.). Arista relied on Amara’s disclosure of “internal applications,” which Arista identified as corresponding to the recited “control plane processes,” and argued that a person of ordinary skill in the art would have understood that physical network interface ports 202, 204, and 206 are configurable by the internal applications. (*Id.* (citing RX-0447 at Fig. 3, 5:53-55).). However, Dr. Mir’s testimony that this limitation is met based on, for instance, disclosure in Amara that “[i]nternal applications include applications on device 10, such as applications for controlling and configuring *device 10*” is not persuasive. (Tr. (Mir) at 1699:25–1700:14 (emphasis added); RX-0447 at 2:27-31.). Amara’s disclosure that internal applications control or configure the “device” is not adequately specific as to whether the interface ports are an aspect of the device being controlled or configured by the internal applications. (RX-0447 at 2:27-31.). This interpretation is supported by Dr. Almeroth’s testimony:

Q: And does Amara ’743 reference disclose some other claim elements, claim 1a and 55a?

A: It does not. If you turn to CDX-9C at 39, I’m focused on claim 1a and claim 55a that have very similar language around the physical network interface ports being configurable by control plane processes. And one of the key pieces of evidence that Dr. Mir relies on is this citation at column 4, lines 34 through 35 of the Amara patent. And it says, “running on device 100 are internal applications, which typically serve to control or configure device 100.” It’s not describing

¹¹⁴ Arista relied on this reference as anticipating prior art against, *inter alia*, claims 1 and 55 of the ’668 patent in an IPR proceeding brought before the PTAB. (*See* IPR2015-00974, Paper 2 (Apr. 1, 2015).). The PTAB denied institution of the IPR on the basis that Arista did not establish a reasonable likelihood that it would prevail in showing that, *inter alia*, claims 1 and 55 are unpatentable as anticipated by Amara. (*See* IPR2015-00974, Paper 7 at 9-14 (Oct. 6, 2015).). Even under the PTAB’s lower “reasonable likelihood of success” standard for instituting *inter partes* review, the panel found that Amara did not sufficiently disclose physical ports being “configurable by control plane processes” and “port services . . . defined by control plane configurations.” (*Id.* at 9-14.)

Public Version

configuring the physical interface ports. *It's just talking about configuring the device.*

(Tr. (Almeroth) at 2561:17–2562:5 (emphasis added); CDX-0009C at 39; RX-0447 at 4:34-35.).

As Dr. Almeroth pointed out, Amara discloses that “[r]unning on device **100** are internal applications **114**, which *typically* serve to to [sic] control or configure *device 100*.” (RX-0447 at 4:34-35 (emphases added).). Nothing in Amara ties internal applications to configuring the interface ports. Moreover, Amara’s disclosure that internal applications control or configure the device only “typically” suggests that they do not necessarily serve that purpose and, therefore, that another component of device **100** may serve that purpose.

Additionally, Arista claimed that Amara discloses “port services . . . as defined by control plane configurations.” (RBr. at 49.). Arista relied on Amara’s disclosure of policy engines **224-228** as corresponding to the “port services” recited in claims 1 and 55, and argued that these elements are configured by the internal applications 230 based on, for example, input from administrators. (*Id.* (citing RX-0447 at Fig. 3, 1:29-46, 1:63–2:9, 2:14-17, 2:27-31, 2:48-60, 5:16-21, 6:3-8, 6:12-16).). However, Dr. Mir’s testimony that this limitation is met based on, for example, disclosure in Amara that “[i]n general, policy engines **26-30** may be separately configured so as to apply different policies” is not persuasive. (Tr. (Mir) at 1700:21–1701:8.). The Amara reference does not sufficiently disclose that Amara’s interface ports, as opposed to the “device” generally, are configurable. Amara does not adequately disclose that Amara’s internal applications actually configure these interface ports.

For these reasons, it is a finding of this Initial Determination that claim 1 is not invalid as anticipated by the Amara reference.

Public Version

ii. Claims 2, 4, 5, 8, 18, and 56

For the reasons stated above in the discussion of claims 1 and 55 in Section VII.E.1.b.i, it is a finding of this Initial Determination that Amara does not anticipate claims 1 and 55. Since claims 2, 4, 5, 8, and 18 ultimately depend from claim 1, Amara does not anticipate claims 2, 4, 5, 8, and 18. *See Certain Static Random Access Memories and Prods. Containing Same*, Inv. No. 337-TA-792, 2013 WL 1154018, at *10 (U.S.I.T.C. Feb. 25, 2013) (holding that because the independent claim was not anticipated, claims depending from the independent claim were also not anticipated) (citing *Hartness Int'l, Inc. v. Simplimatic Eng'g Co.*, 819 F.2d 1100, 1108 (Fed. Cir. 1987)). Since claim 56 depends from claim 55, Amara does not anticipate claim 56. *Id.*

2. Obviousness

Arista claimed that claim 7 of the '668 patent is obvious in view of the combination of the JUNOS Guide or Amara and U.S. Patent No. 6,460,146 to Moberg *et al.* ("Moberg"). (RBr. at 51-52; RX-0448.). Moberg issued on October 1, 2002, from U.S. Patent Application No. 09/205,577, filed on December 4, 1998. (RX-0448.). Arista asserts that Amara is prior art to the '668 patent under 35 U.S.C. § 103. (RBr. at 51-52; RPBr. at 117.).

Arista also claimed that claims 10, 13 and 64 of the '668 patent are obvious in view of the combination of the JUNOS Guide or Amara and U.S. Patent No. 6,970,943 to Subramanian *et al.* ("Subramanian"). (RBr. at 51-52; RX-0449.). Subramanian issued on November 29, 2005, from U.S. Patent Application No. 09/736,692, filed on December 13, 2000, and claims priority to Provisional Application No. 60/239,484, filed on October 11, 2000. (RX-0449.).

a) Claim 7 in view of JUNOS and Moberg

Since Arista has not proven by clear and convincing evidence that the JUNOS Guide is prior art to the '668 patent, the JUNOS Guide, in combination with Moberg, does not render

obvious claim 7. *See, e.g., Northern Telecom, Inc. v. Datapoint Corp.*, 908 F.2d 931, 936-37 (Fed. Cir. 1990) (accused infringer carries the burden of establishing that a reference is prior art by clear and convincing evidence.).

b) Claim 7 in view of Amara and Moberg

Moberg relates to providing processor redundancy in a system such as router. (*See, e.g.,* RX-0448 at 2:33-34; *see also id.* at Abstract.). Arista has not clearly and convincingly demonstrated that the Amara reference, in combination with Moberg, renders claim 7 obvious.¹¹⁵ As Dr. Almeroth testified, as person of ordinary skill in the art would not have been motivated to combine Amara with Moberg because the devices disclosed in Amara are directed at reducing the complexity involved in applying policies to all packets, which would have been frustrated by introducing multiple processors or distributed control plane processing. (Tr. (Almeroth) at 2563:2-7.).

In support of its contention, Arista relied on Dr. Mir's testimony that a disclosure in Moberg that "the present invention relates to providing processor redundancy in a system such as a router" would motivate a person of ordinary skill in the art to combine Amara with Moberg. (Tr. (Mir) at 1687:12-1688:22.). However, Dr. Mir did not explain why that would be so, or rely on other evidence that would demonstrate why this disclosure would have actually provided such a motivation to combine Moberg with a reference like Amara. Dr. Mir did not provide any explanation of how the additional limitation of "multiple processors" would be obvious in view

¹¹⁵ Arista relied on the combination of Amara and Moberg in making its argument that, *inter alia*, claim 7 of the '668 patent is obvious in view of Amara in combination with Moberg. (*See* IPR2015-00974, Paper 2 (Apr. 1, 2015).). The PTAB concluded that under its "reasonable likelihood of success" standard for instituting *inter partes* review, claim 7 would not have been obvious in view of Amara and Moberg. (*See* IPR2015-00974, Paper 7 at 14-15 (Oct. 6, 2015).). The "reasonable likelihood of success" standard is lower than the "clear and convincing" standard required for this Investigation.

Public Version

of Amara combined with Moberg. Additionally, Dr. Mir did not present a plausible rationale as to why combining Amara with Moberg would have worked together. *See, e.g., PharmaStem Therapeutics, Inc. v. ViaCell, Inc.*, 491 F.3d 1342, 1360 (Fed. Cir. 2007) (noting that “the burden falls on the patent challenger to show by clear and convincing evidence that a person of ordinary skill in the art would have had reason to attempt to make the composition or device, or carry out the claimed process, and would have had a reasonable expectation of success in doing so”).

Additionally, as discussed above with regard to anticipation of claims 1 and 55 by Amara in Section VII.E.1.b, the combination still lacks physical ports being “configurable by control plane processes” and “port services . . . defined by control plane configurations,” as required by claim 1, from which claim 7 depends. Neither Arista nor Dr. Mir presented any evidence or testimony that the additional reference teaches these limitations or that these limitations would be obvious based on the disclosures of the combined references.

For these reasons, claim 7 is not obvious in view of Amara in combination with Moberg.

c) Claims 10, 13, and 64 in view of JUNOS and Subramanian

Since Arista has not proven by clear and convincing evidence that the JUNOS Guide is prior art to the '668 patent, the JUNOS Guide, in combination with Subramanian, does not render obvious claims 10, 13, and 64.

d) Claims 10, 13, and 64 in view of Amara and Subramanian

Subramanian describes a routing architecture, which includes a control plane, a compute plane, and a forward plane, for processing and routing packets in a network, and in particular, for providing high-speed, application level processing on the packets during routing. (*See, e.g., RX-0449 at 1:18-21; see also Abstract.*). Arista has failed to meet its burden and demonstrate by clear and convincing evidence that the Amara reference, in combination with Subramanian,

renders claims 10, 13, and 64 obvious.¹¹⁶

Dr. Mir testified that Subramanian discloses a distributed data plane, distributed switch engines, and distributed control plane port services, as recited in claims 10, 13 and 64, respectively. (Tr. (Mir) at 1690:22–1691:1, 1693:2-7, 1695:23–1696:1, 1716:21–1717:20, 1719:8-12.). In support of its contention, Arista relied on testimony by Dr. Mir that a person of ordinary skill in the art would see the teaching in Subramanian and be motivated to combine the reference with Amara in order to enable a system to “handle more traffic.” (Tr. (Mir) at 1691:11-20.). Dr. Mir’s testimony does not provide any explanation or support that this disclosure would have actually motivated a person of ordinary skill in the art to combine Subramanian with a reference like Amara. Dr. Mir also failed to provide any explanation for how the additional limitations recited by claims 10, 13, and 64 would be obvious in view of Amara combined with Subramanian. Additionally, Dr. Mir did not present a plausible rationale as to why combining Amara with Subramanian would have worked together. *See, e.g., PharmaStem Therapeutics*, 491 F.3d at 1360 (noting that “the burden falls on the patent challenger to show by clear and convincing evidence that a person of ordinary skill in the art would have had reason to attempt to make the composition or device, or carry out the claimed process, and would have had a reasonable expectation of success in doing so”).

Additionally, as discussed above with regard to anticipation of claims 1 and 55 by Amara in Section VII.E.1.b.i, the combination still lacks physical ports being “configurable by control

¹¹⁶ Arista relied on the combination of Amara and Subramanian in making its argument that, *inter alia*, claims 10, 13 and 64 of the ’668 patent is obvious in view of Amara in combination with Subramanian. (*See* IPR2015-00974, Paper 2 (Apr. 1, 2015)). The PTAB concluded that under its “reasonable likelihood of success” standard for instituting *inter partes* review, claims 10, 13 and 64 would not have been obvious in view of Amara and Subramanian. (*See* IPR2015-00974, Paper 7 at 14-15 (Oct. 6, 2015)). The “reasonable likelihood of success” standard is lower than the “clear and convincing” standard required for this Investigation.

Public Version

plane processes” and “port services . . . defined by control plane configurations,” as required by claim 1, from which claim 7 depends. Neither Dr. Mir nor anyone else on behalf of Arista presented any evidence or testimony that the additional reference teaches these limitations or that these limitations would be obvious based on the disclosures of the combined references.

For these reasons, claims 10, 13, and 64 are not rendered obvious in view of Amara in combination with Subramanian.

e) Secondary Considerations

Arista has not proven by clear and convincing evidence that claims 7, 10, 13, and 64 are invalid as obvious. Because the evidence is insufficient to demonstrate that the '668 patent is invalid under 35 U.S.C. § 103,¹¹⁷ an analysis of the secondary considerations of nonobviousness is unnecessary.

f) Conclusion

Claims 7, 10, 13, and 64 of the '668 patent are not rendered obvious in view of the JUNOS Guide or the Amara reference, alone or in combination with Moberg or Subramanian. It is a finding of this Initial Determination that Arista did not meet its burden of clearly and convincingly proving that the JUNOS Guide is prior art to the '668 patent. Additionally, Arista has not proven by clear and convincing evidence that one of skill in the art would have been motivated to combine Amara with Moberg or Subramanian, and that such combinations would have worked together.

¹¹⁷ “A patent may not be obtained though the invention is not identically disclosed or described as set forth in section 102 , if the differences between the subject matter sought to be patented and the prior art are such that the subject matter as a whole would have been obvious at the time the invention was made to a person having ordinary skill in the art to which said subject matter pertains. Patentability shall not be negated by the manner in which the invention was made.” 35 U.S.C. § 103(a).

VIII. The '211 Patent

A. Person of Ordinary Skill in the Art

A person of ordinary skill in the art for the '211 patent has been defined as someone who holds at least a Bachelor of Science degree in electrical engineering, computer engineering, or computer science, or an equivalent degree, and approximately two years of related experience in the field of network devices. (*Markman* Order at 66.). Additional formal education in a relevant field, such as work toward a master's degree, would have reduced the amount of industry experience one of skill would have needed in the art. (*Id.* at 67.).

B. Infringement

1. '211 Accused Switches

Cisco has accused Arista's networking switches including the 7010, 7048, 7050, 7050X, 7150, 7250X, 7280E, 7300, 7300X, and 7500E series ("211 Accused Switches"), of directly and indirectly infringing claims 2, 6, 13, and 17 of the '211 patent. (*See* CBr. at 63; *see also id.* at Attach. C.). These switches run Arista's EOS software¹¹⁸ with the Multi-Chassis Link Aggregation ("MLAG") feature. (*Id.* (citing, e.g., CX-0221 (Arista User Manual) at CSI-ANI-00128383-000052).). The MLAG feature is used to "logically aggregate ports across two switches" by means of a peer link.¹¹⁹ (*Id.* (citing CX-0221 (Arista User Manual) at CSI-ANI-00128383-000510); RX-0427C (Multi-Chassis LAG (MLAG) Training) at 10). This MLAG pair can then be connected through link aggregation to other devices, such as a host, switch, or network device. (CX-0377C at ANI-ITC-944_945-1126316; CX-0221 (Arista User Manual) at

¹¹⁸ *See supra* note 3 (describing EOS software).

¹¹⁹ MLAG peer-link is defined as a "non-proprietary Ethernet physical link between MLAG peers to synchronize state between MLAG peers." (RX-0427C at 4.).

CSI-ANI-00128383-000510.). One example of network topology using MLAG is illustrated below: [

]

(RDX-127C (derived from RX-0427C) (discussed at Tr. (Guerin) at 1427:2–1429:14).).

2. Direct Infringement

Cisco has accused the '211 Accused Switches of directly infringing claims 2, 6, 13, and 17 of the '211 patent. (*See* CBr. at 63; *see also id.* at Attach. C.). As discussed in further detail below, on a claim-by-claim basis, Cisco has failed to prove by a preponderance of evidence that the '211 Accused Switches directly infringe the asserted claims of the '211 patent.

None of the '211 Accused Switches infringe, asserted claims 2, 6, 13, and 17 because they do not satisfy the “tunneling” limitation required in claims 2 and 13, from which claims 13 and 17 depend. (JX-0001 at 13:27-30, 14:39-45.).

a) Claims 1 and 12.

Cisco has alleged that the '211 Accused Switches directly infringe claims 2 and 13 of the '211 patent. Although claims 1 and 12 were not asserted in this Investigation, claims 2 and 13 depend from claims 1 and 12, respectively. Thus, a separate analysis of claims 1 and 12 is

necessary to assess infringement of claims 2 and 13. For the reasons discussed below, the '211 Accused Switches infringe claims 1 and 12 of the '211 patent when they are connected to a server. The '211 Accused Switches do not infringe claims 1 and 12 of the '211 patent when the '211 Accused Switches are connected to a third switch, and not a "host," as the term has been construed.¹²⁰

i. "aggregating [configured to aggregate] a plurality of LANs, wherein said aggregating comprises aggregating [configured to aggregate] a first LAN and a second LAN"

Cisco claimed, and Arista did not dispute, that the '211 Accused Switches meet the referenced limitation of claims 1 and 12 of the '211 patent. (CBr. at 64; RBr. at 75-84.). For example, Arista's MLAG feature of the EOS software running in the '211 Accused Switches enables "two 10-gigabit Ethernet ports, one each from two MLAG configured switches" to connect (via a first LAN and a second LAN) to "two 10-gigabit ports" on a third device to "create a link that appears as a single 20-gigabit port." (CX-0221 at CSI-ANI-00128383.000510.). An Ethernet port is used to provide a physical connection to a host. (*See id.*). Based on this evidence, Cisco's expert, Dr. Kevin Jeffay,¹²¹ testified that [

] (Tr. (Jeffay) at 1281:3-24; JX-0032C at 201:12-17.). Accordingly, because there is no dispute, Cisco has met its burden and proven by a preponderance of the evidence that limitation i of claims 1 and 12 of the '211 patent is met by the '211 Accused Switches.

¹²⁰ The agreed-upon construction of the term "host" is "an end station, which is the source of, or destination of, frames transmitted over a network." (*Markman* Order at 67; *see also infra* App. A Section VI.A.).

¹²¹ At the time of his testimony, Dr. Kevin Jeffay ("Dr. Jeffay") was a Chairman of the Department of Computer Science at University of North Carolina, Chapel Hill. (CPSt. at Ex. C.). Dr. Jeffay was also a Professor in Computer Science at University of North Carolina, Chapel Hill. (*Id.*). Cisco retained Dr. Jeffay as an expert to provide testimony with regard to the claims construction, technical background, infringement, technical domestic industry, and validity of the '211 patent. (*Id.* at 2.).

- ii. "said first LAN couples a host to a first intermediate device and said second LAN couples said host to a second intermediate network device, said plurality of LANs comprising said first LAN and said second LAN"*

Cisco claimed, and Arista did not dispute, that the '211 Accused Switches meet the referenced limitation of claims 1 and 12 of the '211 patent when the '211 Accused Switches are connected to a server as the "host." (CBr. at 64-65; RBr. 75-84.). Arista's expert, Dr. Guerin, testified that Arista's non-infringement argument does not apply when a pair of MLAG switches is connected to a server as a host. (Tr. (Guerin) at 1479:18–1480:22.).

Arista did not dispute that Arista and its customers actually connect Arista's MLAG configured switches to servers, thereby meeting the limitations of this claim element. (See Tr. (Jeffay) at 1282:20–1283:10; CX-0353C at 4-5). Arista's documents show a pair of MLAG switches connected to two servers as endpoints. [

]

(RX-0427C (Multi-chassis LAG (MLAG) Training at 10). Accordingly, because there is no dispute, Cisco has met its burden and proven by a preponderance of the evidence that the accused products meet this limitation of claims 1 and 12 of the '211 patent, when they are

Public Version

connected to a server as a host.

Additionally, Cisco alleged that the '211 Accused Switches meet this limitation of claims 1 and 12 of the '211 patent when the '211 Accused Switches are connected to a switch. Here, Cisco failed to meet its burden and prove by a preponderance of the evidence that Arista's switches function as an "end station, which is the source of, or destination, of frames transmitted over a network" within the context of the '211 patent. (*Markman* Order at 67.). Because of the disclosure in the '211 patent specification (*see, e.g.*, JX-0001 at 1:62-64, 1:45-47, 1:21-23), and the adopted constructions of "host" and "intermediate device,"¹²² a switch, i.e., an intermediate network device, is not also a "host."

Cisco relied upon the testimony of its expert, Dr. Jeffay, to support its assertions.

[

]

(Tr. (Jeffay) at 1286:13-18)).

In the passage quote, Dr. Jeffay offered an opinion that the Arista switches meet the claim limitations that require a "host" based in part upon the July 17, 2015 deposition testimony of Mr. Zeqing Xia,¹²³ one of Arista's engineers. (*Id.* (Jeffay) at 1286:23–1287:16.). In his deposition, Mr. Xia indicates that [

¹²² The agreed-upon construction of "intermediate device" is "a device used to interconnect LANs and/or other types of transmission media, such as a bridge, router, or switch." (*Markman* Order at 67.).

¹²³ At the time of his testimony, Mr. Zeqing Xia ("Mr. Xia") was a software engineer at Arista. (JX-0043C at 8:1-2.).

] (JX-0043 at 41:21-

24.). Although this testimony may support Cisco’s contention that a switch can serve the function as a host generally, the testimony does not address Arista switches specifically.

To show that Arista switches can be the source or the destination of packets, and therefore a “host,” Dr. Jeffay used the [

] which he later admitted on cross-examination are not relevant to the infringement analysis [] (Tr. (Jeffay)

at 1287:22–1288:4, 1396:7-11.). The final evidence to which Cisco cites is an Arista User

Manual dated October 2, 2014. (CX-0221 at CSI-ANI-00128383.000956). The page cited by

Cisco, however, discusses only [] which, Dr. Jeffay acknowledged are not relevant

to Cisco’s infringement analysis. (Tr. (Jeffay) at 1396:7-11.). Accordingly, Cisco has failed to

meet its burden to prove that Arista’s switches function as a “host” in the context of the ’211 patent.

iii. “subsequent to said aggregating, said first LAN and said second LAN are both usable to simultaneously transmit information from said host to said second intermediate network device”

Cisco claimed, and Arista did not dispute, that the ’211 Accused Switches meet this limitation of claims 1 and 12 of the ’211 patent. (CBr. at 67; RBr. at 75-84.). Dr. Jeffay testified that, based on the July 30, 2015 deposition testimony from Mr. Nathan Arroyo¹²⁵ (JX-0019C at

¹²⁴ STP BPDU is an acronym for “Standard Tree Protocol Bridge Protocol Data Units.” (CX-0221 at CSI-ANI-00128383.000953.). Spanning tree bridges continuously transmit topology information to notify all other bridges on the network when topology changes are required, such as when a link fails. BPDUs are STP information packets that bridges exchange. (*Id.*).

¹²⁵ At the time of his testimony, Mr. Nathan Arroyo (“Mr. Arroyo”) was a software engineer at Arista. (JX-0019C at 73:19-21.).

Public Version

70) and Mr. Bechtolsheim (JX-0021C at 308), the accused products involve “simultaneous transmission, so a host can use both of its LANs simultaneously.” (Tr. (Jeffay) at 1283:25–1284:9; *see also id.* at 1284:10-24.). These links are in an [] (*Id.* (Jeffay) at 1284:7-9.).

In its Pre-Hearing Brief, Arista did not assert any non-infringement arguments with respect to this claim limitation. (RPBr. at 159-68.). In its initial Post-Hearing Brief, Arista improperly raised for the first time that it disputes infringement of this claim limitation. (RBr. at 83.). Thus, under Ground Rule 11.2, Arista’s assertion and any arguments are deemed waived. (*See* G.R. 11.2.).

Accordingly, because Arista did not properly assert its non-infringement position in a timely fashion, Cisco has met its burden and demonstrated by a preponderance of the evidence that limitation iii of claims 1 and 12 of the ’211 patent is met by the ’211 Accused Switches.

iv. Conclusion

The ’211 Accused Switches infringe claims 1 and 12 of the ’211 patent when they are connected to a server as the claimed “host.” Additionally, the ’211 Accused Switches do not infringe claims 1 and 12 of the ’211 patent when the ’211 Accused Switches are connected to a third switch because a third switch does not meet the agreed-upon construction of a “host.”

b) Claims 2 and 13.

- i. “The method of claim 1 [The computer program of claim 12], further comprising: tunneling [configured to tunnel] said first LAN with a third LAN through said first intermediate network device, said plurality of LANs comprising said third LAN.”**

Cisco has failed to meet its burden to prove by a preponderance of the evidence that the accused devices practice the additional limitation of “tunneling said first LAN with a third LAN

Public Version

through said first intermediate network device, said plurality of LANs comprising said third LAN.” The term “tunneling” has been construed to mean “transmitting a frame without examination.” (*Markman* Order at 75.). By contrast, Arista presented evidence that the ’211 Accused Switches subject the accused control packets to at least three, and with IGMP¹²⁶/PIM,¹²⁷ four, examinations: [

] (*See, e.g.*, JX-0026C at 167:7–168:14, 174:25–176:15, 181:5-8, 184:23–186:1; JX-0019C at 44:9-13, 46:5–49:4; RX-0429C at ANI-ITC-944_945-1126336.).

[

] which is inconsistent with the adopted construction of the term “tunneling, which requires that frames be transmitted “without examination.” (Tr. (Guerin) at 1432:15-23; *Markman* Order at 75.). [

¹²⁶ “IGMP” is an acronym for “Internet Group Management Protocol.” (CX-0221 at CSI-ANI-00128383.001774.). IGMP is used by networks to control the flow of layer 3 multicast traffic. (*Id.*).

¹²⁷ “PIM” is an acronym for “Protocol Independent Multicast.” (CX-0221 at CSI-ANI-00128383.000046.).

¹²⁸ “CPU” is an acronym for “central processing unit.” (JX-0004 at 4:61.). “CPU trapping” involves the transmission of control packets to the CPU for handling. (CX-2552C at ¶ 67.).

¹²⁹ “Berkeley Packet Filtering” refers to examining packets to determine whether they are the types of packets that should be forwarded. (CX-2552C at ¶ 67.).

Public Version

(Tr. (Jeffay) at 1342:18-24, 1343:4-7; *see also id.* at 2434:10-23, 2434:24–2335:23.). [

(Tr. (Jeffay) at 1357:20–

1358:5.). [

] (Tr. (Guerin) at 1433:3-9.). Thus, the '211 Accused Switches subject the accused control packets to examination.

[

] (*Id.* at 1437:1-24, 1443:19-23.). Thus, the '211 Accused Switches subject the

Public Version

accused control packets to examination, which, again, is inconsistent with the adopted construction of the term “tunneling.”

[

] (Tr. (Jeffay) at
1344:21–1345:8.). Thus, the '211 Accused Switches subject the accused control packets to
examination, which is inconsistent with the adopted construction of the term “tunneling.”

[

] (Tr. (Jeffay)
at 1384:9-18.). Thus, the '211 Accused Switches subject the accused control packets to
examination, which, again, is inconsistent with the adopted construction of the term “tunneling.”

Public Version

Because there are multiple examinations of the accused packets, and frames are not transmitted “without examination,” as the term has been construed, the ’211 Accused Switches do not infringe claims 2 and 13 of the ’211 patent.

c) Claims 6 and 17.

The ’211 Accused Switches do not infringe claims 2 and 13 of the ’211 patent. Since claims 6 and 17 of the ’211 patent depend from claims 2 and 13, respectively, claims 6 and 17 are not infringed. *See Muniauction*, 532 F.3d at 1328-29 n.5 (“A conclusion of noninfringement as to the independent claims requires a conclusion of noninfringement as to the dependent claims.”); *Monsanto*, 503 F.3d at 1359 (“One who does not infringe an independent claim cannot infringe a claim dependent on (and thus containing all the limitations of) that claim.”); *Wahpeton Canvas*, 870 F.2d at 1553 (“It is axiomatic that dependent claims cannot be found infringed unless the claims from which they depend have been found to have been infringed.”).

d) Conclusion

The ’211 Accused Switches do not meet the “tunneling” limitation required by claims 2 and 13 of the ’211 patent because the accused packets in the ’211 Accused Switches undergo multiple examinations. (*See, e.g.*, Tr. (Guerin) at 1432:15-23, 1437:1-14, 1438:8–1435:1, 1440:8–1441:20).). Thus, the ’211 Accused Switches do not infringe these claims. Since the remaining asserted claims, that is, claims 6 and 17 ultimately depend from claim 2, the ’211 Accused Switches do not infringe claims 6 and 17. *See, e.g., Wahpeton Canvas*, 870 F.2d at 1553.

3. No Direct Infringement of the ’211 Patent in the United States

For the reasons stated above in Section VIII.B.2, the ’211 Accused Switches do not directly infringe any of the claims 2, 6, 13, and 17 of the ’211 patent. Accordingly, Arista’s

customers do not directly infringe the asserted claims of the '211 patent.

4. No Indirect Infringement

For the reasons stated above in the discussion of asserted claims 2, 6, 13, and 17 in Section VIII.B.2, the '211 Accused Switches do not directly infringe any of the asserted claims. Because the '211 Accused Switches do not directly infringe, it is axiomatic that they cannot indirectly infringe after importation, either through contributory infringement or inducement. *See Limelight Networks, Inc. v. Akamai Techs., Inc.*, 134 S.Ct. 2111, 2117 (2014) (quoting *Afro Mfg. Co. v. Convertible Top Replacement Co.*, 365 U.S. 336, 341 (1961)) (“[L]iability for inducement must be predicated on direct infringement. This is for good reason, as our case law leaves no doubt that inducement liability may arise ‘if, but only if, [there is] . . . direct infringement.’”) (alteration in original); *Dynacore Holdings Corp. v. U.S. Philips Corp.*, 363 F.3d 1263, 1274 (Fed. Cir. 2004) (noting that in order to prevail under a theory of indirect infringement, plaintiffs must first prove that the defendants’ actions led to direct infringement of the asserted patent); *Aro Mfg. Co. v. Convertible Top Replacement Co.*, 365 U.S. 336, 341-42 (1961) (“It is plain that [§] 271(c) . . . made no change in the fundamental precept that there can be no contributory infringement in the absence of a direct infringement.”); *In re Bill of Lading Transmission & Processing Sys. Patent Litig.*, 681 F.3d 1323, 1333 (Fed. Cir. 2012) (quoting *Linear Tech. Corp. v. Impala Linear Corp.*, 379 F.3d 1311, 1326 (Fed. Cir. 2004)) (“It is axiomatic that ‘[t]here can be no inducement or contributory infringement without an underlying act of direct infringement.’”).

C. Technical Prong¹³⁰

1. Cisco's DI Products.

Cisco identified two series of products as practicing claims 1, 2, 6, 12, 13, and 17 of the '211 patent: (1) Catalyst 6500 Series of switches ("Catalyst DI Products"), which support the virtual switching system (VSS)¹³¹ feature; and (2) Nexus 3000, 5000, and 7000 Series of switches ("Nexus DI Products"), which support the virtual port-channel (vPC)¹³² feature (collectively, "'211 DI Products"). (CBr. at 77; Tr. (Jeffay) at 1313:5-15.). As discussed in more detail below, on a claim-by-claim basis, the record evidence does not establish that the '211 DI Products practice the asserted claims of the '211 patent.

2. Claims 1 and 12.

- a) **"aggregating [configured to aggregate] a plurality of LANs, wherein said aggregating comprises aggregating [configured to aggregate] a first LAN and a second LAN"**

Cisco claimed, and Arista did not dispute, that the '211 DI Products meet the preamble. Based, *inter alia*, on Cisco's technical documents for the Catalyst and Nexus DI Products (CX-0339; CX-0355; CX-0418), Dr. Jeffay testified that the VSS and vPC features are used to group links connected from a host to two DI Products into a single logical link. (Tr. (Jeffay) at 1313:23–1316:5; CX-0418 at CSI-ANI-00201978; CX-0339 at CSI-ANI-00118541; CX-0355 at CSI-ANI-00121487–89; *see also* CX-0337 at CSI-ANI-00128326.000018–19 (white paper

¹³⁰ For a discussion of the legal framework of the DI technical prong, *see supra* Section V.D.1.

¹³¹ "VSS" is an acronym for "virtual switching system." (*See, e.g.*, CX-0337 at CSI-ANI-00128326.000002.). The Cisco Catalyst 6500 Series VSS allows the clustering of two or more physical chassis together into a single, logical entity. (*Id.*). To neighboring devices, the Cisco VSS appears as a single, logical switch or router. (*Id.*).

¹³² "vPC" is an acronym for "virtual Port Channels." (*See, e.g.*, CX-0355 at CSI-ANI-00121483.000003.). A vPC allows links that are physically connected to two different Cisco Nexus Series devices to appear as a single port channel to a third device, which can be a switch, server, or any other networking device that supports link aggregation technology. (*Id.* at CSI-ANI-00121483.000004.).

specifically describing the operation of the VSS feature in the Catalyst DI Products).).

Accordingly, because there is no dispute, Cisco has met its burden and proven by a preponderance of the evidence that the '211 DI Products meet the limitation (a) of claims 1 and 12 of the '211 patent.

- b) **“said first LAN couples a host to a first intermediate device and said second LAN couples said host to a second intermediate network device, said plurality of LANs comprising said first LAN and said second LAN”**

Cisco claimed, and Arista did not dispute, that the '211 DI Products practice this limitation when the products are connected to a server. (CBr. at 78.). Based, *inter alia*, on Cisco's technical documents for the Catalyst and Nexus DI Products (CX-0200; CX-0339), Dr. Jeffay testified that ports on the Catalyst DI Products, configured for VSS, and the Nexus DI Products, configured for vPC, connect to devices such as servers. (Tr. (Jeffay) at 1316:6-16; CX-0200 at 4-16; CX0339 at CSI-ANI-00118535.000205.). Accordingly, because there is no dispute, Cisco has met its burden and proven by a preponderance of the evidence that the '211 DI Products practice this limitation of claims 1 and 12 of the '211 patent.

Additionally, Cisco argued that the '211 DI Products meet this limitation when the '211 DI Products are connected to a switch. (CBr. at 78.). Here, Cisco failed to meet its burden and prove by a preponderance of the evidence that switches function as an “end station, which is the source of, or destination, of frames transmitted over a network” within the context of the '211 patent. Based on the disclosure in the '211 patent specification (*see, e.g.*, JX-0001 at 1:62-64, 1:45-47, 1:21-23) and the adopted constructions of “host”¹³³ and “intermediate device,”¹³⁴ a

¹³³ The agreed-upon construction of the term “host” is “an end station, which is the source of, or destination of, frames transmitted over a network.” (*Markman* Order at 67.).

switch, i.e., an intermediate network device, is not also a “host.” Moreover, Dr. Jeffay’s testimony provided no analysis of how the switches in the ’211 DI Products operate as a “host,” under the adopted construction. Dr. Jeffay simply referenced Cisco’s technical documents (CX-0200; CX-0339) and stated that “you can use a router, a switch or a server with a virtual switching system [VSS]” as a host, and that “for vPC, . . . the third device can be a switch, server or other networking device.” (Tr. (Jeffay) at 1316:10-16.). Therefore, the weight of the evidence is that the ’211 DI Products do not practice limitation (b) of claims 1 and 12 of the ’211 patent when connected to a switch.

c) “subsequent to said aggregating, said first LAN and said second LAN are both usable to simultaneously transmit information from said host to said second intermediate network device”

Cisco claimed, and Arista did not dispute, that the ’211 DI Products practice this limitation of claims 1 and 12 of the ’211 patent. (CBr. at 78.). Cisco’s technical documents for the Catalyst and Nexus DI Products demonstrate that subsequent to configuring the ’211 DI Products as a VSS or vPC pair, the first and second LANs are both usable to simultaneously transmit information to one of the switches in the pair. (*See, e.g.*, CX-0355 at CSI-ANI-00121483.000004, ’016, ’059, ’098-99; CX-0200 at CSI-ANI-00118776.000093).).

Accordingly, because there is no dispute, Cisco has met its burden by a preponderance of the evidence that the ’211 DI Products practice limitation (c) of claims 1 and 12 of the ’211 patent.

d) Conclusion

For the reasons set forth above, the ’211 DI Products, when connected to a server as a “host,” practice claims 1 and 12 of the ’211 patent and thus meets the technical prong of the

¹³⁴ The agreed-upon construction of “intermediate device” is “a device used to interconnect LANs and/or other types of transmission media, such as a bridge, router, or switch.” (*Markman* Order at 67.).

domestic industry requirement with respect to the '211 patent.

Cisco only was required to establish that its '211 DI Products practice a single claim of an asserted patent. *Certain Ink Jet Print Cartridges and Components Thereof*, Inv. No. 337-TA-446, Comm'n Opinion at n.3 (May 8, 2002) (noting that "Complainants must show that . . . they practice at least one claim of the patents at issue") (citing *Certain Variable Wind Turbines and Components Thereof*, Inv. No. 337-TA-376, Comm'n Opinion (Sept. 23, 1996)). However, Cisco's remaining assertions with respect to certain dependent claims of the '211 patent will be addressed below. As discussed below, Cisco has failed to meet its burden and demonstrate that the '211 DI Products practice claims 2, 6, 13, and 17 of the '211 patent. (Sections VIII.C.3-4.).

3. Claims 2 and 13.

- a) "The method of claim 1 [The computer program of claim 12], further comprising: tunneling [configured to tunnel] said first LAN with a third LAN through said first intermediate network device, said plurality of LANs comprising said third LAN."**

It is a finding of this Initial Determination that Cisco failed to meet its burden and demonstrate by a preponderance of the evidence that the '211 DI Products practice the "tunneling" limitation recited in claims 2 and 13 of the '211 patent. One of Cisco's technical documents, entitled "Cisco Catalyst 6500 Series Virtual Switching System," states (and confirms) that the forwarding engines in Catalyst DI Products "perform lookup functions for every frame that enters into the system, and determine the ultimate destination of the packet" "provide value-added services, such as security access control list (ACL) and quality of service (QoS) lookups." (CX-0337 at 11.). Dr. Jeffay confirmed the information with regard to Cisco's Catalyst products by acknowledging that forwarding engines for the Catalyst DI products "perform lookup functions for every frame that enters into the system." (Tr. (Jeffay) at 1370:11–

1372:13.).

Q: Okay. Well, let's go to of this document [CX-0337] page 11. Can we blow up this "optionally" paragraph? It says here, sir, with respect to the Catalyst system, "these forwarding engines perform lookup functions for every frame that enters into the system and determine the ultimate destination of the packet." Do you see that?

A: I do.

Q: And they also provide value-added services, such as access control list and QOS. Do you see that?

A: I do.

Q: That happens for every packet coming in; [sic] correct?

A: Yes.

Q: And that's examination; [sic] correct?

A: So with—we're back to our discussion about my reluctance to use that specific word, because this examination is not precluded by the claims. But you're certainly looking at the packet, I don't dispute that at all.

(Tr. (Jeffay) at 1371:18–1372:13.).

In addition, Dr. Jeffay testified that the referenced lookups occur while the packet is inside the switch. (Tr. (Jeffay) at 1371:5-9.).

With respect to the Nexus DI Products, except to assert that the spanning tree packets are tunneled, Dr. Jeffay provided no analysis with regard to how the packets are treated in support of his assertion that spanning tree packets are tunneled. (Tr. (Jeffay) at 1316:17–1317:16.).

Accordingly, the '211 DI Products do not practice the additional limitation set forth in claims 2 and 13.

4. Claims 6 and 17.

- a) **"The method of claim 2 [The computer program product of claim 13] wherein said aggregating comprises: aggregating [configured to aggregate] a first and a second port of said**

second intermediate network device, wherein said first port is coupled to said first intermediate network device over said third LAN, and said second port is coupled to said host over said second LAN.”

For the reasons stated above in the discussion of claims 2 and 13 of the '211 patent, it is a finding of this Initial Determination that the '211 DI Products do not practice claims 2 and 13 of the '211 patent. Since claims 6 and 17 depend from claims 2 and 13, respectively, the '211 DI Products do not practice claims 6 and 17. *See Alloc*, 342 F.3d at 1375 (“The test for satisfying the ‘technical prong’ of the domestic industry requirement is essentially [the] same as that for infringement, i.e., a comparison of domestic products to the asserted claims.”); *Muniauction*, 532 F.3d at 1328-29 n.5 (“A conclusion of noninfringement as to the independent claims requires a conclusion of noninfringement as to the dependent claims.”); *Monsanto*, 503 F.3d at 1359 (“One who does not infringe an independent claim cannot infringe a claim dependent on (and thus containing all the limitations of) that claim.”); *Wahpeton Canvas*, 870 F.2d at 1553 (“It is axiomatic that dependent claims cannot be found infringed unless the claims from which they depend have been found to have been infringed.”).

5. Conclusion

For the reasons set forth above, it is a finding of this Initial Determination that the '211 DI Products do not practice claims 2, 6, 13 and 17. Although the analysis above in Section VIII.C.2 concludes that the '211 DI Products practice claims 1 and 12 of the '211 patent, the '211 DI Products do not satisfy the technical prong of the domestic industry requirement with respect to the '211 patent. As discussed below (*see infra* Section VIII.D.2), claims 1 and 12 of the '211 patent have been found invalid and, therefore, cannot be relied upon to establish the technical prong of the domestic industry requirement. *See, e.g., Certain Ground Fault Circuit*

Public Version

Interrupters and Prods. Containing Same, Inv. No. 337-TA-739, Comm'n Opinion, 2012 WL 2394435, at *46 (June 8, 2012) (citing *Bayer AG v. Elan Pharm. Research Corp.*, 212 F.3d 1241, 1247 (Fed. Cir. 2000) (“To prevail [on the test for satisfying the technical prong], the patentee must establish by a preponderance of the evidence that the domestic product practices one or more *valid* claims of the patent, either literally or under the doctrine of equivalents.”) (emphasis added)). Accordingly, Cisco has failed to meet its burden and show that the '211 DI Products practice at least one valid claim of the '211 patent. Therefore, Cisco has not satisfied the technical prong of the domestic industry requirement for the '211 patent.

D. Validity

1. Perloff

Perloff issued on June 21, 2005, from U.S. Patent Application No. 09/961,471, filed on September 24, 2001. (RX-0374.). Arista argued that Perloff is prior art to the '211 patent at least under 35 U.S.C. §§ 102(e) and 103.¹³⁵ (RBr. at 90-91.). The technology disclosed in Perloff is directed to “multi-device link aggregation (MDLA), which allows any partner device that employs the IEEE.802.3ad standard for link aggregation to transparently connect aggregated links to a pair of devices supporting MDLA as though they were a single device that also supports the IEEE 802.3ad standard, thereby providing ‘box-level’ redundancy.” (RX-0374 at 1:7:14; *see also id.* at 3:9-15.).

2. Anticipation

Arista argued that U.S. Patent No. 6,910,149 to Perloff, et al. (“Perloff”) anticipates claims 1 and 12 of the '211 patent. (RBr. at 89; RX-0374.). On October 5, 2016, the PTAB

¹³⁵ *See supra* note 77 (recitation of 35 U.S.C. §§ 102(e)).

issued its decision concluding that claims 1 and 12 of the '211 patent are anticipated by Perloff. (See IPR2015-00975, Paper 36 at 14-17, 25 (Oct. 5, 2016)). Accordingly, claims 1 and 12 of the '211 patent are invalid as a matter of law and do not require resolution in this Investigation. See 35 U.S.C. § 318(a).¹³⁶

3. Obviousness

a) Perloff

Arista argued that claims 2, 6, 13 and 17 of the '211 patent are obvious in view of Perloff.¹³⁷ (RBr. at 91.). However, as discussed in more detail below, Arista has not proven by clear and convincing evidence that the prior art reference invalidates the asserted claims of the '211 patent. Arista did not provide any evidence that identified any teaching, suggestion, motivation, or reason in Perloff that would have prompted a person of ordinary skill to modify the device disclosed in Perloff to perform, or be configured to perform, the step of “tunneling,” as required by independent claims 2 and 13. See, e.g., *PharmaStem Therapeutics, Inc. v. ViaCell, Inc.*, 491 F.3d 1342, 1360 (Fed. Cir. 2007) (“[T]he burden falls on the patent challenger to show by clear and convincing evidence that a person of ordinary skill in the art would have had reason to attempt to make the composition or device, or carry out the claimed process, and would have had a reasonable expectation of success in doing so.”). Additionally, Arista does not support with evidence how a person of ordinary skill in the art would have had the knowledge to make such a device, or to carry out the claimed process. See *id.* Since dependent claims 6 and

¹³⁶ 35 U.S.C. § 318(a) reads as follows: “If an *inter partes* review is instituted and not dismissed under this chapter, the Patent Trial and Appeal Board shall issue a final written decision with respect to the patentability of any patent claim challenged by the petitioner and any new claim added under section 316(d).”

¹³⁷ The PTAB concluded that claims 2, 6, 13, and 17 have not been shown to be unpatentable in light of the combination of Perloff and U.S. Patent No. 6,931,529. (IPR2015-00975, Paper 36 at 20-25 (Oct. 5, 2016)). Thus, these claims are still valid.

17 depend from claims 2 and 13, respectively, Perloff does not render obvious claims 6 and 17 for the same reason. *See Wahpeton Canvas*, 870 F.2d at 1553.

i. Claims 2 and 13

- (a) “The method of claim 1 [The computer program of claim 12], further comprising: tunneling [configured to tunnel] said first LAN with a third LAN through said first intermediate network device, said plurality of LANs comprising said third LAN.”

Arista has failed to meet its burden to prove by clear and convincing evidence that claims 2 and 13 are obvious in view of Perloff. In support of Arista contention that Perloff discloses the claimed “tunneling” limitation, Arista’s expert, Dr. Guerin, relies on a passage from Perloff that describes “transparently forward[ing]” LACPDU¹³⁸ control packets. (Tr. (Guerin) at 1474:6-22 (discussing RDX-0157; RX-0374 at Fig. 4, 9:58-61).). However, this passage, without anything more, does not clearly and convincingly show that the “transparently forward[ed]” packets disclosed in Perloff are being transmitted without examination. As Dr. Jeffay observed, there is no discussion of tunneling, and specifically internally transmitting without examination, in Perloff. (Tr. (Jeffay) at 2415:14–2416:4.).

Dr. Jeffay testified that Perloff uses a process-and-forward mechanism that performs “examination.” (Tr. (Jeffay) at 2410:7–2413:15, 2416:5-14.). Specifically, Dr. Jeffay testified that Perloff discloses “first and second MDLA devices 102 and 104 [that] exchange LACPDUs received from devices on their non-MDLA ports.” (RX-0374 at 9:37-43.). Dr. Jeffay testified

¹³⁸ “LACP” is an acronym for “link aggregation control protocol.” (RX-0374 at 1:65-66.). “Link aggregation is the bundling of multiple links into a single aggregated logical link with greater aggregate data bandwidth.” (*Id.* at 1:55-57.). The IEEE 802.3ad standard defines a LACP “for use by the control process within each device employing link aggregation to verify configurations and to send packets through each of the links within the aggregated logical link.” (*Id.* at 1:65–2:2.). “LACPDU” is an acronym for “link aggregation control protocol data units.” (*Id.* at 9:35-36.). Switches that implement this protocol exchange information by transmitting LACPDUs. (*See, e.g., id.* at 6:7-14, 9:35–10:27.).

that:

Q: What do you understand generally this passage that Dr. Guerin has cited to refer to?

A: Generally what this is saying is that these MDLA devices are performing the LACP protocol, the first sentence there says that they are handled in accordance with the IEEE 802.3ad standard, and that's the standard for LACP. So it's discussing the fact that the endpoints—the MDLA devices are going to be processing these control packets, and then exchanging them. So each MDLA device will *process* the packet and then send it to the—its corresponding device.

Q: And what does that mean when you say that the LACP will be processing each of the control packets?

A: What I mean is that it's actually running the LACP protocol, so it's implementing the protocol, so it's *processing* the packets for the purpose of providing the functions that LACP provides.

(Tr. (Jeffay) at 2409:20–2410:12 (emphases added).). This type of processing is contrasted with “tunneling” in the '211 patent. For example:

[W]hen a bridge receives a frame, it generally *examines* the frame to determine the corresponding LAN Segment to forward the frame to. Additionally, a bridge will *process* the frame according to a number of protocols. However, in accordance with the present invention, bridge 342 is configured to internally transmit a frame between bridge inter-connect port 366 and port A0 directly, *without such examination*.

(JX-0001 at 5:61–6:1 (emphases added).).

Arista did not provide any evidence that identified any teaching, suggestion, motivation, or reason in Perloff that would have prompted a person of ordinary skill to modify the device disclosed in Perloff to perform, or be configured to perform, the step of “tunneling,” under the adopted construction. *See, e.g., PharmaStem Therapeutics*, 491 F.3d at 1360.

Additionally, Arista did not support with evidence that a person of ordinary skill in the art would have had a reasonable expectation of success in attempting to do so. *See id.* As Dr. Jeffay testified, there is no motivation in Perloff to bypass examination because the invention disclosed

Public Version

in the reference “fundamentally relies on LACP and in particular both of the MDLA devices fully participating in the protocol.” (Tr. (Jeffay) at 2416:7-14.). Thus, a person of ordinary skill in the art could not and would not modify Perloff to transmit packets without examination.

Dr. Guerin also testified that the asserted claims of ’211 patent are rendered obvious by a combination of Perloff and “known techniques”: (1) the “encapsulation” technique described in a Kurose and Ross textbook; and (2) the “physical tunnel” technique disclosed in the ’211 patent itself. (Tr. (Guerin) at 1474:10-16, 1419:10–1420:24.). However, as Cisco raised in its Motion to Strike No. 3, which has been granted (*see supra* Section I.C.2.a.iii), neither Arista nor Dr. Guerin had previously alleged any invalidity theory based on a combination of Perloff and these techniques. Therefore, Arista has been precluded from relying on these “known techniques” because it provided no evidentiary support for its contention before the hearing.

For these reasons, Perloff does not render obvious claims 2 and 16 of the ’211 patent.

ii. Claims 6 and 17

- (a) “The method of claim 2 [The computer program product of claim 13] wherein said aggregating comprises: aggregating [configured to aggregate] a first and a second port of said second intermediate network device, wherein said first port is coupled to said first intermediate network device over said third LAN, and said second port is coupled to said host over said second LAN.”

It is a finding of this Initial Determination that claims 2 and 13 of the ’211 patent are not obvious in view of Perloff. Since claims 6 and 17 depend from claims 2 and 13, respectively, Perloff does not render obvious claims 6 and 17. *See, e.g., Otsuka Pharm. Co., Ltd. v. Sandoz, Inc.*, 678 F.3d 1280, 1296 (Fed. Cir. 2012) (holding there was no need to separately analyze the lower court’s ruling on the asserted dependent claims because the independent claim at issue was not obvious over the asserted prior art).

b) Secondary Considerations

Arista has not proven by clear and convincing evidence that claims 2, 6, 13, and 17 are invalid as obvious. Because the evidence is insufficient to demonstrate that the '211 patent is invalid under 35 U.S.C. § 103, an analysis of the secondary considerations of nonobviousness is unnecessary.

c) Conclusion

Claims 2, 6, 13, and 17 of the '211 patent are not rendered obvious in view of Perloff. In particular, the Perloff reference does not disclose, and Arista has not sufficiently identified or provided evidence of a teaching, suggestion, or motivation for why a person of ordinary skill would have been prompted to modify the device disclosed in Perloff to perform, or be configured to perform, the step of "tunneling," as required in claims 2 and 13. Even if there was a reason to attempt to carry out the claimed method (claim 2) or make the claimed device (claim 13), Arista has similarly provided no evidentiary support that a person of ordinary skill in the art would have had a reasonable expectation of success in doing so. *PharmaStem Therapeutics*, 491 F.3d at 1360. Since dependent claims 6 and 17 depend from claims 2 and 13, respectively, it is a finding of this Initial Determination that Perloff does not render obvious claims 6 and 17 for the same reason. *Wahpeton Canvas*, 870 F.2d at 1553.

IX. DEFENSES

A. Equitable Estoppel

The evidence does not support applying the doctrine of equitable estoppel to bar relief with respect to the '577, '853, '668, '875, '492, and '211 patents. (*See supra* Section VI.E.1 (discussing applicable law)).

1. There Was No Misleading Conduct by Cisco

The weight of the evidence adduced in this Investigation does not demonstrate that Cisco's conduct led Arista to believe reasonably that Cisco would not assert its patent rights against Arista. Evidence establishes that Cisco was not aware of Arista's infringement of the '211 patent until approximately May 21, 2014, and the '875 patent until September 20, 2014. (*See, e.g.,* RX-0011C at Interrog. Resp. 8.).

Cisco filed its Complaint in this Investigation in December 2014 just seven (7) months after it became aware of the possibly infringing '211 patent and only three (3) months after Cisco became aware of the possibly infringing '875 patent. (*Id.*). Evidence also demonstrates that Cisco had no knowledge of Arista's infringing activities with regard to the '668, '492, '577, and '853 patents until approximately June 26, 2014, again less than eight (8) months before Cisco filed its Complaint in this Investigation. (*Id.*). That Cisco did not file suit against Arista before these dates does not amount to "intentionally misleading silence" for which equitable estoppel should apply. *See, e.g., Aspex Eyewear Inc. v. Clariti Eyewear, Inc.*, 605 F.3d 1305, 1310 (Fed. Cir. 2010) (noting that "intentionally misleading silence arises when a patentee 'threatened immediate or vigorous enforcement of its patent rights but then did nothing for an unreasonably long time'" (quoting *Meyers v. Asics Corp.*, 974 F.2d 1304 (Fed. Cir. 1992)); *Scholle Corp. v. Blackhawk Molding Co.*, 133 F.3d 1469 (Fed. Cir. 1998) (sustaining dismissal on grounds of equitable estoppel based on the following: (1) Scholle, the patentee, notified Blackhawk that one of Blackhawk's products infringed a Scholle patent; (2) when Blackhawk asked which claims were allegedly infringed, Scholle did not respond; (3) Blackhawk provided Scholle with samples of a new product and stated that it would consider the new product non-infringing unless Scholle

Public Version

advised otherwise, to which Scholle did not respond; and (4) three years later, Scholle sued Blackhawk for infringement).

Arista has argued that “Cisco’s actions here are strikingly similar to those that caused the patent to be unenforceable in *Stryker*.” (RBr. at 62.). In that case, the court found that the plaintiff, Zimmer, *knew* about Stryker’s infringing product for more than four years before suing Stryker. *Stryker Corp. v. Zimmer*, 741 F. Supp. 509, 511 (D.N.J. 1990). That is not the case here. As discussed directly above, Cisco did not have knowledge that certain Arista products infringed the patents-in-suit until May (’211 patent), June (’668, ’492, ’577, and ’853 patents), and September of 2014 (’875 patent). (*See, e.g.*, RX-0011C at Interrog. Resp. 8.). Just months after learning of Arista’s infringing activities, Cisco filed a suit against Arista in Federal District Court on December 9, 2014,¹³⁹ ten (10) days before filing suit in this Investigation. (Doc. ID No. 551422 (Respondent’s Answer) at ¶ 66 (admitting that Arista was served a copy of the District Court Complaint on December 9, 2014 and that it alleges infringement of the asserted patents).).

The weight of the adduced evidence also supports a finding that Cisco has not been “silent” about asserting its rights against potential infringing competitors. (*See* CX-0490 (Huawei Complaint)). For example, in 2003, Cisco brought suit against Huawei Technologies, Co. Ltd, Huawei America, Inc. and Futurewei Technologies, Inc. for patent infringement. (*Id.* at CSI-ANI-00675877.). Mr. Bechtolsheim, Mr. Cheriton, and Ms. Ullal, Arista’s CEO, testified that they were aware of this case. (JX-0021C at 326:11-14; JX-0023C at 115:19–116:2; JX-0041C at 161:12-20.). In addition, in a wholly unsupported claim, Arista suggested that while “virtually all of Cisco’s competitors openly market alleged infringing features,” Cisco singled

¹³⁹ *Cisco Sys., Inc. v. Arista Networks, Inc.*, Case No. 3:14-cv-5343 (N.D. Cal. Dec. 5, 2014).

Public Version

out Arista. (RBr. at 58.). However, Arista has failed to point to any evidence of such infringement. (*Id.*). Instead, Arista relied solely on testimony from Mr. Dan Lang,¹⁴⁰ a Cisco employee, that he was “not aware” of Cisco ever having sent a “notice letter accusing any company of infringing the asserted patents.” (Tr. (Lang) at 2680:17-19.).

Additionally, the record evidence does not demonstrate that Cisco’s public statements with regard to its patents rights could lead Arista to “reasonably infer” that Cisco would not enforce its patents against Arista. *Certain Bearings and Packaging Thereof*, Inv. No. 337-TA-469, Initial Determination at 28. Arista was aware that Cisco had been licensing its patented technology to its competitors. (RX-1038 (press release announcing a patent cross-licensing agreement between Cisco and Google); RX-1071 (1996 Cisco 10-K); RX-1072 (2014 Cisco 10-K); CX-0539 (Samsung patent cross-license agreement.). Licensing is one of several ways to exercise patent rights. Therefore, any statements and agreements with regard to licensing should have led Arista to believe that those in the industry, including Cisco, would assert their patent rights, not the opposite.

Arista also argued that Cisco’s promotion of the control plane protection functionality as a *de facto* standard, through its submission of RFC 6192¹⁴¹ to the IETF,¹⁴² led industry participants knowledgeable about the RFC, including Arista, to believe that there were no Cisco patents covering the published technology because Cisco failed to disclose the ’668 patent in

¹⁴⁰ At the time of his testimony, Mr. Dan Lang (“Mr. Lang”) was the Vice President of Intellectual Property and Deputy General Counsel of Cisco. (Tr. (Lang) at 2653:14-16.). Cisco designated Mr. Lang as a fact witness to provide testimony regarding: (1) licensing and standards issues; and (2) assignor estoppel. (CPSt. at 3.).

¹⁴¹ “RFC” is an acronym for “Request for Comments.” (*See, e.g.*, CX-0488 at CSI-ANI-00666183.). RFC 6192 is a submission Cisco provided to the IETF with regard to “Protecting the Router Control Plane.” (*See* CX-0489.).

¹⁴² “IETF” is an acronym for “Internet Engineering Task Force.”

connection with the RFC submission. (RBr. at 59-60.). However, Arista has failed to provide any evidence that Cisco attempted to “conceal” the ’668 patent. (RBr. at 60.). To the contrary, the weight of evidence demonstrates that Cisco disclosed the ’668 patent within a reasonable time after discovering a potential relationship between the ’668 patent and the RFC. For example, Mr. Lang gave the following testimony:

Q: Okay. When did Cisco first become aware of any potential relationship between the ’668 patent and the subject matter of RFC 6192?

A: Well, it was . . . recently discovered . . . just a couple weeks before December 5 [date the *inter partes* review (IPR) was filed].

(Tr. (Lang) at 2694:25–2695:4.). With regard to disclosing IPR, IETF’s disclosure policies simply require the following:

If a Contributor first learns of IPR¹⁴³ in its Contribution that meets the conditions of Section 6.6, for example a new patent application or the discovery of a relevant patent in a patent portfolio, after the Contribution is published in an Internet-Draft, a disclosure must be made as soon as reasonably possible after the IPR becomes reasonably and personally known to the Contributor.

(CX-0488 at CSI-ANI-00666192.).

Additionally, under the IETF policies, “[n]o patent search is required”. (*Id.* at CSI-ANI-00666187.). Thus, under these circumstances, Cisco’s disclosure was timely and in compliance with IETF policies.

2. There Was No Reliance by Arista

“To show reliance, the infringer must have had a relationship or communication with the

¹⁴³ “IPR” is an acronym for “Intellectual Property Rights.” (CX-0488 at CSI-ANI-00666186.). An IPR is a “patent, copyright, utility model, invention registration, database and data rights that may cover an Implementing Technology, whether such rights arise from a registration or renewal thereof, or an application therefore, in each case anywhere in the world.” (*Id.*) IETF policies require that “[i]f a Contributor first learns of IPR in its Contribution that meets the conditions of Section 6.6, for example a new patent application or the discovery of a relevant patent in a patent portfolio, after the Contribution is published in an Internet-Draft, a disclosure must be made as soon as reasonably possible after the IPR becomes reasonably and personally known to the Contributor.” (*Id.* at CSI-ANI-00666192.).

Public Version

plaintiff which lulls the infringer into a sense of security.” *Aukerman*, 960 F.2d at 1043; *see also Windbond Elecs. Corp. v. Int’l Trade Comm’n*, 262 F.3d 1363, 1374 (Fed. Cir. 2001) (noting that “the alleged infringer must have knowledge of the patentee and its patent and must reasonably infer that the patentee acquiesced to the allegedly infringing activity for some time (citing *Aukerman*, 960 F.2d at 1042.). Evidence adduced in this Investigation does not support Arista’s claim that there was any communication or relationship with Cisco such that Arista was legally entitled to infer that Cisco would not assert its patents.

Arista claimed that it first became aware of the asserted patents on December 4, 2014. (JX-0076C at ¶ 60 (Mr. Duda stated in his Witness Statement that Arista first became aware of the six (6) patents asserted in this Investigation on December 4, 2014, when “Arista was asked by a member of the press to comment on a lawsuit that Cisco had told them it was planning to file the next day in the Northern District of California.”); *see also* Resp. at § 66.).¹⁴⁴ Therefore, Arista could not have relied on any statement, action, or inaction by Cisco to support a belief that Cisco “acquiesced” to Arista’s activities or that Cisco would not enforce its patents. *Aukerman*, 960 F.2d at 1042 (“[F]or equitable estoppel the alleged infringer cannot be unaware—as is possible under laches—of the patentee and/or its patent.”).

The evidence also consists of additional testimony that undermines completely Arista’s argument:

- [] (JX-00041C at 159:25–161:1);

- [] (JX-

¹⁴⁴ The Complaint was filed in the Northern District of California on December 5, 2014. (Resp. at § 66.). Arista was served the Complaint on December 9, 2014. (*Id.*).

0021C at 326:11-14; JX-0023C at 115:19–116:2; JX-0041C at 161:12-20);

- [] (JX-0041C at 159:17-23.).

With regard to the RFC, Arista argued [

] (RX-1054C). However, [

]

(*Id.*). There is nothing [] to suggest, let alone support, a claim that Arista relied on RFC 6192 to develop its products or to form a reasonable belief that Cisco had “acquiesced” to Arista’s infringing activities. Moreover, Mr. Holbrook, one of Arista’s engineers, testified that [] (Tr. (Holbrook) at 1839:7-21.). Thus, Arista could not have relied on the document and the absence of the disclosure of the ’668 patent at the time of the submission. Even if, *arguendo*, RFC 6192 had been submitted close in time when Arista was developing the products at issue in this Investigation, and Arista relied on the absence of documents such as on the IPR disclosure, the IETF policies explicitly caution against such reliance:

It should . . . be noted that the *absence of IPR disclosures is not the same thing as the knowledge that there will be no IPR claims in the future*. People or organizations not currently involved in the IETF or people or organizations that discover IPR they feel to be relevant in their patent portfolios can make IPR disclosures at any time.

(CX-0488 at CSI-ANI-00666195 (emphasis added).).

3. There Was No Prejudice to Arista

Arista has failed to prove that it was materially prejudiced by Cisco’s conduct because

¹⁴⁵ []

Public Version

Arista has not shown a “change of economic position” or that its expenditures have a proven nexus to Cisco’s alleged delay. *Aukerman*, 960 F.2d at 1043. Arista claimed that during Cisco’s alleged delay in enforcing its patent rights, it “invested significant resources to develop the accused products” and that during this time, “Arista’s sales steadily increased as it gained a greater foothold into the market which has resulted in a substantial product base deployed by network users throughout the country.” (RBr. at 64.). However, the Federal Circuit has held that this type of investment in production of allegedly infringing products is not sufficient to show material prejudice.

[T]he record reflects that CES had expenditures of over \$23 million on research and development, \$6.5 million on direct marketing costs, and \$20 million to expand or consolidate manufacturing facilities. But these expenditures have *no explicitly proven nexus to the patentee’s delay in filing suit*, as *Aukerman* requires for a finding of prejudice. It is not enough that the alleged infringer changed his position—i.e., invested in production of the allegedly infringing device. *The change must be because of and as a result of the delay, not simply a business decision to capitalize on a market opportunity.*

Hemstreet v. Comput. Entry Sys. Corp., 972 F.2d 1290, 1293-94 (Fed. Cir. 1992) (emphases added) (internal citation omitted) (citing *Aukerman*, 960 F.2d at 1033). Thus, Arista has not proven it has been materially prejudiced such that equitable estoppel could bar relief in this Investigation.

For these reasons, Cisco’s claims are not barred by the equitable doctrine of estoppel.

B. Implied License and Waiver

Arista claimed that the following activities by Cisco support a finding of implied license and waiver: (1) creating and promoting a *de facto* standard; (2) withholding its IPR disclosure until it was too late for Arista to develop an alternative technology; (3) publicly avoiding litigation in favor of licensing; and (4) singling out Arista’s implementation of a *de facto*

standard feature. (RBr. at 64.). However, for the reasons discussed in more detail below, the evidence adduced in this Investigation does not support a finding that the equitable doctrines of implied license and waiver should bar Cisco from relief.

1. There Was No Implied License

“The primary difference between the estoppel analysis in implied license cases and the analysis in equitable estoppel cases is that implied license looks for an *affirmative* grant of consent or permission to make, use, or sell: i.e., a license.” *Wang Labs., Inc. v. Mitsubishi Elecs. Am., Inc.*, 103 F.3d 1571, 1580-81 (Fed. Cir. 1997). Arista was required to prove that Cisco conducted in such a way that led Arista to infer consent to use Cisco’s patents. As discussed above in Section IX.A.1 with regard to Arista’s equitable estoppel defense, Arista has failed to provide any evidence that Cisco engaged in language or conduct that could be interpreted as “an affirmative grant of consent or permission” for Arista to use the Cisco patents asserted in this Investigation. Moreover, the record evidence supports a finding that the IETF submission was a “non-standards track informational RFC that was not intended for standardization” and, thus, carried no licensing obligations. (Tr. (Djavaherian)¹⁴⁶ at 2457:19-2462:10; RX-0391; CX-2357; CX-0489).). For these reasons, Cisco’s claims are not barred by the equitable doctrine of implied license.

2. There Was No Waiver

“[W]aiver is the ‘intentional relinquishment or abandonment of a known right.’” *United States v. Olano*, 507 U.S. 725, 733 (1993) (quoting *Johnson v. Zerbst*, 304 U.S. 458, 464 (1938)). For its waiver defense, Arista relied on the same facts as its implied license defense.

¹⁴⁶ At the time of his testimony, Mr. David Djavaherian (“Mr. Djavaherian”) was the President of PacTech Consulting, LLC. (CPSt. at Ex. F.). Cisco retained Mr. Djavaherian as an expert to provide testimony rebutting Arista’s equitable defenses, including testimony relating to standards. (*Id.* at 2.).

Public Version

For the same reasons its implied license defense fails, so, too, does its waiver defense. “To support a finding of implied waiver in the standard setting organization context, the accused must show by clear and convincing evidence that ‘[the patentee’s] conduct was so inconsistent with an intent to enforce its rights as to induce a reasonable belief that such right has been relinquished.’” *Hynix Semiconductor Inc. v. Rambus, Inc.*, 645 F.3d 1336, 1348 (Fed. Cir. 2011) (citing *Qualcomm Inc. v. Broadcom Corp.*, 548 F.3d 1004, 1020 (Fed. Cir. 2008)). This conduct can be shown where: “(1) the patentee had a duty of disclosure to the standard setting organization, and (2) the patentee breached that duty.” *Id.* (citing *Qualcomm*, 548 F.3d at 1011-12).

As explained above in Section IX.A.1 with regard to Arista’s equitable estoppel defense and the IETF’s policies on IPRs, Cisco’s IPR disclosure of the ’668 patent was timely and compliant with the IETF policies. (See CX-0488 at CSI-ANI-00666192 (IETF Disclosure Policy); *id.* at CSI-ANI-00666187 (“[n]o patent search is required”).). The evidence adduced in this Investigation establishes that Cisco was unaware of a connection between the ’668 patent and RFC 6192 until 2014. Within a mere few weeks after becoming aware of the possible relevance of the ’668 patent to the technology disclosed in the RFC 6192 submission, Cisco submitted the IPR disclosure. (See, e.g., Tr. (Lang) at 2694:25–2695:4; CX-0489.). Cisco’s timely disclosure was not “so inconsistent with an intent to enforce its rights” that waiver can be found. *Hynix Semiconductor*, 645 F.3d at 1348.

Arista cites to *Qualcomm Inc. v. Broadcom Corp.* in support of its argument that “the creation of a standard constitutes sufficient misconduct to give rise to waiver.” (RBr. at 65 (citing *Qualcomm Inc. v. Broadcom Corp.*, 548 F.3d 1004, 1022 (Fed. Cir. 2008).). In *Qualcomm*, the plaintiff had actual knowledge that it had patents that “reasonably might be

necessary” to a formal standard and was found to have breached its disclosure requirement.

Qualcomm, 548 F.3d at 1018. By contrast, Cisco had no such knowledge. Accordingly, it is a finding of this Initial Determination that Cisco did not breach a duty to disclose any information with respect to its patents and did not fail to comply with IETF policies.

For these reasons, Cisco’s claims are not barred by the equitable doctrine of waiver.

C. Laches

Evidence adduced in this Investigation supports a finding that Cisco did not delay in bringing an infringement lawsuit for an “unreasonable and inexcusable” length of time from when it knew or reasonably should have known of its infringement claim against Arista.

Aukerman, 960 F.2d at 1035-36.

With regard to the ’668, ’875, ’492, ’577, and ’853 patents, Arista argued that Cisco should have been aware of the accused functionalities since their release in 2008 because Arista’s activities were “sufficiently prevalent” in Cisco’s field of endeavor and within the scope of Cisco’s monitoring efforts. (RBr. at 68, 118; RBr.II at 42.). With respect to the ’211 patent, Arista argued that Cisco should have been aware of the MLAG functionality in 2009, when the product was released. (RBr. at 98.). However, the record evidence establishes that Cisco was not aware of Arista’s infringement of the ’211 patent until approximately May 21, 2014 and the ’875 patent until September 20, 2014. (*See, e.g.*, RX-0011C at Interrog. Resp. 8.). Evidence also reflects that Cisco had no knowledge of Arista’s infringing activities with regard to the ’668, ’492, ’577, and ’853 patents until approximately June 26, 2014. (*Id.*).

Mr. Lang, one of Cisco’s fact witnesses, testified that Cisco’s legal team did not test Cisco’s products in 2008 for infringement. (JX-0057C at 147:5-16.). While some of Cisco’s employees may have had knowledge of certain features in Arista’s products (*see, e.g.*, Tr. (Lang)

Public Version

at 2679:24–2680:5, 2700:2-12; Tr. (Jiandani) at 166:17–167:3, 1162:5-11), Cisco was under no duty to investigate the functionality of these devices. *Wanless v. Fedders Corp.*, 145 F.3d 1461, 1465-66 (Fed. Cir. 1998) (noting that a duty to investigate applies if reasonable patentee should have known of infringement, but policing the industry and testing all competitors’ products is not required and would be unreasonable).

Because Cisco did not delay in filing suit for more than six (6) years after actual knowledge of Arista’s infringing activity, a presumption of laches does not apply. *Aukerman*, 960 F.2d at 1035-36. The timeframe from when Cisco first learned of Arista’s conduct until Cisco filed suit does not amount to an “unreasonable or inexcusable” delay. *Id.* at 1028 (accused infringer must prove that plaintiff delayed in bringing an infringement lawsuit for an “unreasonable and inexcusable” length of time from when it knew or reasonably should have known of its infringement claim against the accused infringer).

Arista has failed to establish that it was materially prejudiced by Cisco’s alleged delay because Arista has not shown a “change of economic position” (*id.* at 1045) or that its “expenditures . . . have an explicitly proven nexus to the patentee’s delay in filing suit” (*Hemstreet v. Comput. Entry Sys. Corp.*, 972 F.2d 1290, 1294 (Fed. Cir. 1992)). Arista argued that during Cisco’s alleged delay, it significantly invested in developing and selling the accused products. (RBr. at 63-64.). The Federal Circuit has found that such expenditures do not amount to the “economic prejudice” required for a finding of laches.

“It is not enough that the alleged infringer changed his position—i.e., ***invested in production of the allegedly infringe device***. The change must be because of and as a result of the delay, not simply a business decision to capitalize on a market opportunity.” Prejudice cannot result from a business decision or gamble that the patent owner would not sue.

James River Corp. of Va. v. Hallmark Cards, Inc., 915 F. Supp. 968, 978 (E.D. Wis. 1996)

(emphasis added) (quoting *Hemstreet*, 972 F.2d at 1294) (citing *Gasser Chair Co., Inc. v. Infanti Chair Mfg. Corp.*, 60 F.3d 770, 775 (Fed. Cir. 1995)). Arista made a business decision to invest in products it had reason to know or suspect likely infringed certain of Cisco's patents. *See id.* at 979 (“[F]or Hallmark to take James River’s silence as acquiescence appears to have been a business gamble that James River would not sue. . . . Based on this record, Hallmark has failed to demonstrate a nexus between the delay and its investments, and therefore has not demonstrated there is no genuine factual issue as to economic prejudice.”). Additionally, that Arista continued its infringing activity “is probative of a lack of prejudice.” *Id.* at 978. Accordingly, Arista has not proven that it has been materially prejudiced by any alleged delay on the part of Cisco.

For these reasons, it is a finding of this Initial Determination that Cisco’s claims are not barred by the equitable doctrine of laches.

D. Unclean Hands

A complainant who seeks justice must come into court with clean hands or “the doors of the court will be shut.” *Aptix Corp. v. Quickturn Design Sys., Inc.*, 269 F.3d 1369, 1375 (Fed. Cir. 2001) (quoting *Keystone Driller Co. v. Gen. Excavator Co.*, 54 S.Ct. 146, 147 (1933)). To prove unclean hands, Arista must prove that Cisco “conducted [itself] as to shock the moral sensibilities of the judge.” *Gaudiosi v. Mellon*, 269 F.2d 873, 882 (3d Cir. 1959).

As discussed above in Section IX.A.1 with regard to Arista’s equitable estoppel defense, Arista has failed to provide any evidence that Cisco committed any misleading conduct, fraud or deceit in litigation or before the PTO. Arista claimed that:

- Cisco was aware of Arista’s infringing activities for years but kept “silent” while Arista invested to develop the accused products;
- Cisco publicly touted its license agreements, made public statements about avoiding unnecessary patent litigation, and publicly encouraged the use and

Public Version

adoption of some of the accused features; and

- Cisco submitted an RFC and waited years before filing a “belated” IPR statement.

(*See, e.g.*, Resp. at ¶¶ 16-22; RBr. at 65-66; RX-0015C at ¶ 95; Tr. (Lang) at 2672:3-24; RX-1072 (2014 10-K) at ANI-ITC-944_945-3914848; CX-0512C; CX-0539C; RX-1038; RX-0298C.).

To the contrary, evidence proves that Cisco did not have knowledge that certain Arista products infringed the patents-in-suit until May (’211 patent), June (’668, ’492, ’577, and ’853 patents), and September of 2014 (’875 patent). (*See, e.g.*, RX-0011C at Interrog. Resp. 8.). The weight of the evidence also supports a finding that Cisco has not been “silent” about asserting its rights against potential infringing competitors. (*See, e.g.*, CX-0490 (Huawei Complaint).).

Additionally, the weight of the evidence does not support a finding that Cisco’s public statements regarding its patents rights could lead Arista to reasonably infer that Cisco would not enforce its patents against Arista. (RX-1038 (press release announcing a patent cross-licensing agreement between Cisco and Google); RX-1071 (1996 Cisco 10-K); RX-1072 (2014 Cisco 10-K); CX-0539 (Samsung patent cross-license agreement.). Moreover, the record evidence reflects that Cisco, in compliance with IETF policies, disclosed the ’668 patent within a few weeks after discovering a potential relationship between the ’668 patent and the RFC. (*See* CX-0488 at 192; Tr. (Lang) 2665:4–21, 2684:21–2685:4, 2688:24–2689:9, 2690:1–2695:8; Tr. (Djavaherian) 2462:11–2463:16, 2468:1–2469:23, 2470:8–2471:21, 2483:9–22, 2484:6–2485:3; JX-0057C 114:14–16, 115:5–16; CX-0489 at 2.).

Arista argued that Cisco “has long been in possession of Arista’s highly confidential documents describing Arista’s products and features and never offer[ed] any explanation of the source of the documents or an apology for having them. (*See, e.g.*, RX-0188C (2009 Arista

Public Version

presentation entitled “Arista 7100 Series & Cisco Nexus 5000 Comparison”); RX-0328C (presentation entitled “Arista EOS Precision Data Analyzer”). That Cisco had these documents does not demonstrate that Cisco came before the Commission with unclean hands. Arista did not provide any evidence that clearly proves that Cisco inappropriately obtained any such documents Cisco had in its possession were, in fact, confidential. Mr. Metivier testified that, at times, he himself has generated potentially confidential documents, designated them as confidential, determined later that they were not, and “forget[ten] to remove” the confidential designation. (Tr. (Metivier) at 2089:2-15.).

The four acts Arista identified as having “soiled Cisco’s hands” do not come close to conduct that “shock[s] the moral sensibilities of the judge” or is “offensive to the dictates of natural justice. *Honeywell Int’l, Inc. v. Universal Avionics Sys. Corp.*, 398 F. Supp. 2d 305, 310 (D. Del. 2001) (citing *Gaudiosi v. Mellon*, 269 F.2d 873, 882 (3d Cir. 1959); *Aptix Corp. v. Quickturn Design Sys., Inc.*, 269 F.3d 1369, 1375 (Fed. Cir. 2001)). For these reasons, it is a finding of this Initial Determination that Cisco’s claims are not barred by the equitable doctrine of unclean hands.

E. Patent Misuse

Arista alleged in its Response to the Complaint and in its Pre-Hearing Brief that Cisco should be barred from asserting that Arista infringes the ’668 patent based on the defense of patent misuse. (Resp. at p. 36, ¶ 16; *id.* at p. 38 at ¶ 22; RPBr. at 127.). However, Arista did not raise this contention in its initial Post-Hearing or Post-Hearing Reply Briefs. (RBr. at 55-69; RPBr. at 36-46.). Arista provided no evidence with regard to this defense in this Investigation. Accordingly, under Ground Rule 15.1.1, any arguments on this issue are deemed waived. (*See* G.R. 15.1.1 (“Any factual or legal issues not addressed in the post-hearing briefs shall be deemed

waived.)).

X. ECONOMIC PRONG OF THE DOMESTIC INDUSTRY¹⁴⁷

A. Legal Framework of the Economic Prong

In a Section 337 investigation, the complainant has the burden of proving the existence of a domestic industry relating to the articles protected by the patents-at-issue. 19 U.S.C. § 1337(a)(2). For a patent-based claim, the domestic industry requirement consists of a technical prong and an economic prong. (*See, e.g. Certain Variable Speed Wind Turbines & Components Thereof*, Inv. No. 337-TA-376, USITC Pub. 3003, Comm'n Op. at 14-17 (1996)). A domestic industry must be proven to “exist[s][sic] or is in the process of being established.” 19 U.S.C. §1337(a)(2). The economic prong is satisfied by meeting any one of the following three (3) criteria with regard to articles protected by the patents-at-issue:

- (A) significant investment in plant and equipment;
- (B) significant employment of labor or capital; or
- (C) substantial investment in its exploitation, including engineering.

19 U.S.C. § 1337(a)(3).

The criteria contained in Section 337(a)(3)(A)-(C) are disjunctive; that is, satisfaction of any one of them is sufficient to satisfy the economic prong. *Certain Digital Imaging Devices & Related Software*, Inv. No. 337-TA-717 (Digital Imaging Devices), ID at 305 (U.S.I.T.C. May 12, 2011, *aff'd*, Notice of Commission Decision Not to Review the ALJ's Final ID at 2 (U.S.I.T.C. July 18, 2011)).

In general, “the appropriate date for determining whether a domestic industry exists is the date of the filing of the complaint.” *Certain Video Game Systems and Controllers*, Inv. No. 337-

¹⁴⁷ Cisco asserted that it satisfies the economic prong of the domestic industry requirement for the Asserted Patents. (Compl. at ¶¶ 33-37.).

Public Version

TA-743 (“*Certain Video Games*”), Comm’n Op. at 5, USITC Pub. 4377 (Feb. 2013). In appropriate circumstances, the Commission may consider activities and investments at times other than at the filing of a complaint. *Certain Video Games* at 5-6. Although past expenditures may be considered to support a domestic industry claim, a complainant must be continuing to make qualifying investments at the time the complaint is filed. *Certain Television Sets, Television Receivers, Television Tuners, and Components Thereof*, Inv. No. 337-TA-910, Comm’n Op. at 68 (U.S.I.T.C. Oct. 30, 2015).

B. Sections A, B, and C of Subsection 337(a)(3)

To establish a domestic industry under Subsections 337(a)(3)(A) and (B), investment in plant and equipment, or employment of labor, must be shown to be either “significant” or “substantial” in relation to the articles protected by the patent. *Certain Printing & Imaging Devices & Components Thereof*, Inv. No. 337-TA-690, Comm’n Op. at 26 (U.S.I.T.C. Feb. 17, 2011).

Under Subsection 337(a)(3)(C), a complainant must show “substantial investment in its exploitation, including engineering, research and development, or licensing.” 19 U.S.C. § 1337(a)(3)(C). The substantial exploitation refers to “the patent, copyright, trademark, mask work or design.” 19 U.S.C. § 1337(a)(3); *Certain Microcomputer Memory Controllers, Components Thereof and Products Containing Same*, Inv. No. 337-TA-331, Order No. 6, 1992 WL 811299, at *2 (U.S.I.T.C. Jan. 8, 1992). Moreover, under 19 U.S.C. § 1337(a)(3)(C), a complainant must establish “a nexus between the claimed investment and the asserted patent.” *Certain Integrated Circuit Chips and Prods. Containing the Same*, inv. No. 337-TA-859, Comm’n Op. at 38 (U.S.I.T.C. Aug. 22, 2014).

In analyzing the economic prong under subsections A, B, and C, the Commission

examines whether the domestic activities and investments in the form of the criteria identified in the statute (e.g., significant employment of labor or capital) are “important to the articles protected by the asserted patents in the context of the company’s operations, the marketplace, or the industry[.]” *Certain Printing and Imaging Devices and Components Thereof*, Inv. No. 337-TA-690, Comm’n Op. at 30, USITC Pub. 4289 (Nov. 2011). The Commission also considers whether “the complainant’s undertakings had a direct bearing on the practice of the patent.” (*Id.*). Whether investments are considered “substantial” or “significant” “is not measured in the abstract or in an absolute sense,” or according to “any rigid mathematical formula.” *Id.* at 26-27. There is no requirement that the domestic industry conform to a specific size. *Bally/Midway Mfg. Co. v. Int’l Trade Comm’n*, 714 F.2d 1117, 1123 (Fed. Cir. 1983) (citing *In re Von Clemm*, 229 F.2d 441, 444 (CCPA 1955)). However, even after the Federal Circuit’s decision in *Lelo Inc. v. Int’l Trade Comm’n*, 786 F.3d 879, 883 (Fed. Cir. 2015), which requires quantitative analysis, there is still no rigid “bright line” rule with regard to how large a financial investment must be to satisfy the economic prong of the domestic industry requirement.

C. Cisco Has Met Its Burden with Regard to the Economic Prong

As Cisco argued, the decision whether Cisco has established a domestic industry and can tie its investments to its DI Products “is not a close call in this Investigation.” (CBr. at 116.). Whether a “substantial,” “significant” or a quantitative analysis are used, Cisco has met its burden of proof. Staff, in general, agrees with Cisco’s position, and that Cisco has met its burden of proof that Cisco’s investments in the United States meet the economic prong of the domestic industry requirement. (SBr. at 80-87; SRBr. at 36-38.).

Under 19 U.S.C. § 1337(a)(3)(C), a complainant must also establish that there is a nexus between the claimed investment and the asserted patent.” *Certain Integrated Chips and Prods.*

Containing the Same, Inv. No. 337-TA-859, Comm'n Op. at 38 (U.S.I.T.C. Aug. 22, 2014) (EDIS Doc. ID No. 540729.). (“*Certain Integrated Chips*”). A nexus “may readily be inferred based on evidence that the claimed investment is in the domestic industry article, which itself is the physical embodiment of the asserted patent.” (*Id.* at 40.). The Commission has held that “no patent-by-patent allocation is required for research and development investment under subparagraph (C).” (*Id.* at 41). In this case, Cisco’s evidence supports a finding that it can track its research and development (“R&D”) and engineering investments on both a per-patent and a per-product basis.

As a high-level summary, Cisco has invested more than \$1 billion dollars in the research and engineering of its DI Products alone since FY2012, and hundreds of millions of dollars in the employment of labor or capital in its DI Products, which Arista’s economic expert, Dr. Thomas Vander Veen,¹⁴⁸ was unable to refute successfully. (See CX-2590C, *infra*. Section X.D.3; CX-2587C, *infra* Section X.D.2; Tr. (Vander Veen) at 2313:13-2314:22; CX-2599C.). Although Arista tried to dispute the significance of Cisco’s investments in its DI products or that Cisco has established a nexus between its investments and the DI Products, Arista’s only viable lines of critique were: (1) with the methodology that Cisco employed to apportion its expenses; and (2) the variations in the calculations performed by Collin Sacks,¹⁴⁹ a Cisco Operations Manager, and Dr. Gregory Leonard,¹⁵⁰ Cisco’s expert with regard to its economic prong

¹⁴⁸ At the time of his testimony, Dr. Thomas Vander Veen (“Dr. Vander Veen”) was the Managing Director and Principal of Navigant Economics. (RPSt. at Ex. D.). Arista retained Dr. Vander Veen as an expert to provide testimony with regard to: (1) Cisco’s contentions that an industry exists in the United States as to the asserted patents; (2) issues relating to remedy and bonding; and (3) opinions offered by Cisco’s expert witnesses. (*Id.* at 4.).

¹⁴⁹ At the time of his testimony, Mr. Collin Sacks (“Mr. Sacks”) was a Cisco employee and a fact witness designated by Cisco to provide testimony relating to the economic prong of domestic industry. (CPSt. at 3.).

¹⁵⁰ At the time of his testimony, Dr. Gregory Leonard (“Dr. Leonard”) was a Partner at Edgeworth Economics.

investments. (RBr. at 119-121, 123-124.).¹⁵¹ Even then, Arista's critiques and arguments are not sufficient to undermine the sheer strength of Cisco's evidence, let alone that Cisco has not met its burden of proof with regard to its economic investment in its domestic industry ("DI").

D. Complainant Has Established a Domestic Industry with Respect to the Asserted Patents and Products Relating to Patents Under 19 U.S.C. § 1337(a)(3)(A), (B) and (C)

1. Cisco's Investments Under 19 U.S.C. § 1337(a)(3)(C)

Cisco has established that it has made substantial and ongoing investments in the United States in R&D involving its DI Products since 2012. (Tr. (Sacks) at 1531: 15-20; Tr. (Keohane) at 934:22-936:4.). Even after products are made available in the marketplace, Cisco continues to make investments in the continuing development of those DI Products. (Tr. (Sacks) at 1531:15-20; Tr. (Keohane) at 934:22-936:4; *see also* Tr. (Jiandani) 134:19-135:7.). According to unrefuted evidence, Cisco's products practiced its patents at the time Cisco filed its Complaint. (*See* CX-2599C; CX-2600C; *see also* Tr. (Sacks) at 1529:8-19.). Moreover, Cisco's investments have been directed in part to improving the patented features. (*See* Tr. (Leonard) at 2265:17-2266:14; Tr. (Keohane) at 934:22-935:10, 936:1-4.).

As a starting point, evidence reflects that Cisco has extensive facilities in San Jose, California, and in Research Triangle Park, North Carolina where many of Cisco's products are designed and developed. (*See* Tr. (Leonard) at 2187:19-2188:4; Tr. (Sacks) at 1530:16-1631:20; CDX-10C-4, 10C-5, 10C-6.).

(CPSSt. at Ex. D.). Cisco retained Dr. Leonard as an expert to provide testimony with regard to claim construction, technical background, infringement, technical domestic industry, and validity of the '211 patent. (*Id.* at 2.).

¹⁵¹ Arista's expert with regard to the economic prong of Cisco's domestic industry, Dr. Thomas Vander Veen, conceded during the evidentiary hearing that he has not provided the opinion that Cisco does not have a domestic industry in the DI Products. *See* Tr. (Vander Veen) 2298:1-2299:17.

Public Version

In order to calculate its expenses and investments, Cisco maintains a database to track worldwide operating expenses that generates an operating expense report or “OPEX.” (Tr. (Sacks) at 1524:9-18, 1532:10-13, 1533:19-1534:12.).¹⁵² The information in the database is apparently aggregated (or isolated) by fiscal year and Cisco’s business units (“BU”). (See CX-2587C; CX-2590C; CX-2599C.). Dr. Leonard, Cisco’s economic expert, used the worldwide and BU data to apportion Cisco’s U.S. expenditures in the DI Products. He apportioned BU investments to the DI Products based on the ratio of a BU’s revenues corresponding to the DI Products to total revenues for all products. (CBr. at 117 (citing Tr. (Leonard) at 2179:5–2180:3).). He started with worldwide revenues for each business unit for each fiscal year. Then, for each business unit and fiscal year, he calculated worldwide revenues for each of the Cisco DI Products that are part of a given business unit. He determined the percentage of business unit revenues that consist of the DI Product revenues. He then applied revenue apportionment percentages to the worldwide business unit-level engineering and R&D investments analyzed under subsections (A), (B), and (C) to apportion worldwide engineering and R&D investments to each of the DI Products. (See Tr. (Leonard) at 2171:12-16; CDX-0004C-4; CPX-0225C; CPX-

¹⁵² One of Arista’s critiques of Cisco’s evidence was that because Mr. Sacks’ economic investment DI calculations were so at odds with Dr. Leonard’s calculations, that his authentication of business records he maintains, or spread sheets he produced, were suspect or lacking in credibility. (RBr. at 120.). Mr. Sacks was offered as Cisco’s corporate designee on its business data. (Tr. (Sacks) at 1543:11-16.). Additionally, Mr. Sacks provided a verified declaration with respect to Cisco’s DI numbers that were attached to the Complaint. (RX283C; Tr. (Sacks) at 1546:23-1547:6; see also Compl. at Ex. 48.). Arista noted that Cisco relied on different DI contention numbers during the hearing. (RBr. at 120 (citing RX-0284C and CX-2587C).). However, using the same methodology, and the same basic business unit or “BU” numbers that Mr. Sacks used (Tr. (Sacks) at 1551:7-24, 1553:1-15), Mr. Sacks and Dr. Leonard arrived at different investment figures for Cisco’s economic domestic industry. (RBr. at 120-21 (citing JX-55C at 212:21–213:3).). Apparently, Mr. Sacks was unable to explain the differences, while Dr. Leonard did not specifically use or consult Mr. Sacks’ calculations. (*Id.*; JX-55C at 212:21-214:3; Tr. (Leonard) at 2247:24–2248:5, 2248:24–2249: 9.). Although the differences between these two witnesses expose serious flaws, the fact that they were “tens of millions apart,” does not ultimately undermine the fact that Cisco has poured hundreds of millions of dollars into its DI Product investments. (See RBr. at 120-21). From Arista’s own critique, it is evident that other than for raw data, Dr. Leonard did not rely on Mr. Sacks, and Dr. Leonard did perform an independent analysis. (*Id.*).

Public Version

0079C-89C; CPX-0140C-155C; CPX-0223C.). He then excluded Cisco's investments outside the U.S. using the percentage of the numbers of engineers in each BU in the U.S. (Tr. (Leonard) at 2180:5-23.). Dr. Leonard then broke down those figures on a patent-by-patent basis, identifying the DI Product investments on a fiscal year basis. (See CX-2587C; CX-2590C; CX-2599C.).

His apportionment method went even further. He determined apportionment percentages based on Cisco's engineering headcount as of April 15, 2015. Actual engineering headcounts were available for certain business units (Insieme Business Unit or INSBU; the Server Access and Visualization Business Unit or SAVBU; the Enterprise Core Business Unit or ECBU; and the Edge Routing Business Unit or ERBU (see Abbreviations at xxiv-vii.). For these business units, Dr. Leonard calculated the percentage of worldwide engineers based in the United States. Since headcount was not available for the Unified Access Business Unit or UABU, and the Enterprise Backbone Business Unit or EBBU, he used a weighted average percentage of worldwide engineers in the United States based on the headcount from the INSBU, SAVBU, ECBU, ERBU and IOTBU business units. He then applied the engineering headcount apportionment percentages to the worldwide DI Products-related engineering and R&D investments to calculate domestic engineering and R&D investments for each of the DI products. (See SPBr. at 148-49; Tr. (Leonard) at 2180:7-2182:25, 2171:17-20; CX-2585 (engineering headcount data); CDX-0004C; CX-0466C (engineering headcount data.).

Arista challenged Dr. Leonard's methodology and suggested that because of the discrepancies between Mr. Sacks' calculation and Dr. Leonard's calculations, Cisco's figures were "constantly changing and," therefore, were unreliable. (RBr. at 83 (citing *Certain Television Sets, Television Receivers, Television Tuners, & Components Thereof*, Comm'n Op.,

Public Version

Inv. No. 337-TA-910 at 65, 66 (U.S.I.T.C. Oct. 30, 2015); *see also* note 151 *supra*). Arista argued that Cisco, through Dr. Leonard, failed to reconcile “these inconsistencies, contradictions, and unsupported assertions” in its submissions in this Investigation that requires a finding that Cisco did not meet its burden to prove its domestic industry consistent with *Certain Television Sets*. (*Id.* at 83 (citing *Certain Television Sets*, 337-TA-901 at 65).). Similarly, Arista argued that Dr. Leonard failed to consider that Cisco had moved certain engineers to India for the EBBU business unit, and that, therefore, as an example of Cisco’s inconsistencies, that Dr. Leonard’s 80.57% ratio to calculate the number of U.S. engineers for this EBBU unit could have been wrong. (*See* RBr at 84 (citing Tr. (Leonard at 2178:5-18.)).¹⁵³ However, Arista’s speculation is just that.

It is a finding of this Initial Determination that any errors that Arista pointed out do not “weigh significantly against a finding that the economic prong of the domestic industry requirement has been satisfied.” (SRBr. at 36; *see also id.* at 34-37.). Effectively, Staff supports the general methodology that Cisco’s expert, Dr. Leonard, used as being consistent with acceptable methodologies and is “reasonable.” (*See* SBr. at 85-86 (citing *Certain Optoelectronic Devices for Fiber Optic Communications, Components Thereof, and Products Containing the Same*, Inv. No. 337-TA-860, 2013 WL 6979483, at *123 (U.S.I.T.C. Dec. 13, 2013) (“a precise accounting is not necessary...”); *see also* CBr. at 119-20.). Moreover, with respect to

¹⁵³ In its Post-Hearing Reply Brief, Cisco distinguished *Certain Television Sets*, *supra*, by noting that in that case, that complainant did not retain an expert to analyze its DI, leading to a failure to show “coherent, reliable evidence” of its expenditures. (CRBr. at 83 n.46 (quoting *Certain Television Sets*, 337-TA-910, Int. Det. At 178 n.32 (Feb. 27, 2015.)). Additionally, the complainant’s business shifted from the design and support of products before filing the complaint to licensing, and the complainant did not attempt to establish its domestic industry. (*Id.* (citing *Certain Television Sets*, 337-TA-910 at 60, 61.)). Cisco observed that Arista has not noted “a single mistake or error by Dr. Leonard.” (*Id.*). Cisco pointed out a number of errors in Arista’s analysis that this decision adopts. (CRBr. at 83-84.).

Public Version

“significance” or “substantiality,” Staff concurred with Cisco, that given the importance of Cisco’s R&D investments to the products at issue, and to Cisco’s business as a whole, the evidence supports that a large portion of these investments occur in the United States. (*Id.*). Staff concurred that a headcount-based allocation that Dr. Leonard used and found to be reasonable is supported by the evidence. (SBr. at 86 (citing Tr. (Leonard) at 2180:7-23 (R&D expenditures are driven by engineers)). Staff also concurred that the evidence demonstrates a sufficient nexus to the asserted patents, and particularly, the evidence reflects that the asserted DI Products embody each of the asserted patents. (SBr. at 86; *see also* Tr. (Leonard) at 2194:9-18; Tr. (Keohane) at 935:1-10; Tr. (Wicker) at 817:10-15 (that Cisco DI products practice the asserted ’211 patent claims)). There was supporting evidence that the features of the asserted patents involve ongoing work performed by engineers in the United States. (Tr. (Keohane) at 934:22–936:4; 992:22–994: 5 (ongoing work on CoPP feature); Tr. (Leonard) at 2261:11-19; 2265:20–2266:14 (ongoing work in the United States on the patented features)).

According to Dr. Leonard’s apportioned figures, Cisco invested in R&D for the DI Products in the United States: approximately \$244.7 million in FY 2012, \$214.7 million in FY 2013, \$277.8 million in FY 2014, and \$282.9 million during the first half of FY 2015, for a total of just over \$1.0 billion during those three and a half years.

Public Version

Cisco's Investments in Engineering and R&D for the DI Products in the U.S.

Cisco Business Unit	Cisco Domestic Industry Products	FY 2012 (\$)	FY 2013 (\$)	FY 2014 (\$)	FY 2015 (\$)
Unified Access (UABU)	Catalyst 4500 Switch	18,348,362	19,873,365	16,022,228	12,391,171
Enterprise Backbone (EBBU)	Catalyst 6500 Switch	72,746,221	40,420,137	41,469,554	31,111,569
Insieme (INSBU)	Nexus 3000 Switch	(8,014)	620,528	55,067,265	76,857,361
	Nexus 9000 Switch	0	0	19,488,414	64,303,227
Server Access & Virtualization (SAVBU)	Nexus 4000 Switch	1,952,748	932,193	357,747	48,502
	Nexus 5000 Switch	73,983,805	61,931,865	47,597,146	36,503,930
	Nexus 6000 Switch	0	1,918,229	16,740,427	9,015,961
Enterprise Core (ECBU)	Nexus 7000 Switch	67,377,384	85,673,652	79,451,422	52,048,731
Edge Routing (ERBU)	Cisco 12000 Router	10,378,122	3,394,131	1,612,187	621,200

(CBr. at Attach. F (citing CX-2599C)). Dr. Leonard then extrapolated the figures based on a per-DI product basis. (*Id.*).

The table below, to which Mr. Sacks testified, correlates Cisco's patents with its DI Products. (Tr. (Sacks) at 1529:8-1530:14.).

Cisco Domestic Industry Products And Corresponding Asserted Patent	
Asserted U.S. Patent No.	Cisco Domestic Industry Products
6,377,577	Catalyst Switches: 6500 Series Nexus Switches: 3000, 5000, 6000, 7000, 9000 Series
7,023,853	Catalyst Switches: 6500 Series Nexus Switches: 3000, 5000, 6000, 7000, 9000 Series
7,061,875	Catalyst Switches: 4500, 6500 Series Nexus Switches: 3000, 4000, 5000, 6000, 7000 Series
7,224,668	Catalyst Switches: 6500 Series Cisco Routers: 12000 Series Nexus Switches: 7000 Series
7,460,492	Catalyst Switches: 4500, 6500 Series Nexus Switches: 3000, 4000, 5000, 6000, 7000 Series
8,051,211	Catalyst Switches: 6500 Series Nexus Switches: 3000, 5000, 7000 Series

(CDX-10C-02.).

The better and more reliable calculations ultimately were provided by Dr. Leonard, Cisco's expert witness on the economic prong of the domestic industry requirement rather than by Mr. Sacks. (Tr. (Leonard) at 2176:8-16, 2177:14-21; CX-2583C.).

If the data from CDX-10C and CX-2599C are read together, on a per-patent basis from FY 2012 through the first half FY 2015, Cisco invested approximately \$934.3 million in the '577 patent; \$934.3 million in the '853 patent; \$920.4 million in the '875 patent; \$486.3 million in the '668 patent; \$920.4 million in the '492 patent; and \$822.8 million in the '211 patent. (CBr. at 118 (citing CX-2600C); *see also* CX-2599C.). Moreover, Cisco's domestic spending on its DI Products for every year from 2012 to 2015 constituted a greater percentage of its worldwide expenditures than its non-United States investments. (Tr. (Leonard) at 2193:2-16.). An example Cisco uses is that the \$283 million Cisco invested in its DI Products in the United States during FY 2015 was almost four (4) times as much as Cisco invested in R&D products outside the United States. (CBr. at 120 (citing CX-2601C).).

Even without more, Cisco met its burden for its economic domestic industry.

2. Cisco's Investments Under Cisco's Investments Under 19 U.S.C. § 1337(a)(3)(A)

Cisco has made significant investments in plant and equipment for the DI Products. 19 U.S.C. § 1337(a)(3)(A). A two-step apportionment methodology was used to calculate U.S. based expenditures specifically for Cisco's plant and equipment for the DI Products.

Public Version

Cisco's Investments in Plant and Equipment for the DI Products in the U.S.

Cisco Business Unit	Cisco Domestic Industry Products	FY 2012 (\$)	FY 2013 (\$)	FY 2014 (\$)	FY 2015 (\$)
Unified Access (UABU)	Catalyst 4500 Switch	2,301,101	1,919,688	1,207,912	1,042,453
Enterprise Backbone (EBBU)	Catalyst 6500 Switch	11,505,554	5,411,079	6,272,400	4,108,119
Insieme (NSBU)	Nexus 3000 Switch	(49,694)	(702,111)	10,728,592	7,687,777
	Nexus 9000 Switch	0	0	3,796,870	6,432,031
Server Access & Virtualization (SAVBU)	Nexus 4000 Switch	246,892	86,125	44,610	5,924
	Nexus 5000 Switch	9,354,622	5,721,854	5,935,244	4,458,614
	Nexus 6000 Switch	0	177,224	2,037,489	1,101,215
Enterprise Core (ECBU)	Nexus 7000 Switch	13,036,280	20,991,747	15,344,051	10,167,931
Edge Routing (ERBU)	Cisco 12000 Router	2,192,018	397,427	321,032	110,070

(CBr. at Attach. G (citing CX-2587C)).

Between FY 2012 and the first half of FY 2015, Cisco invested more than \$153 million in plant and equipment for its DI Products. (*Id.* at 120 (citing CX-2587C)). According to its investment figures, Cisco invested approximately \$38.5 million in FY 2012, \$34 million in FY 2013, \$45 million in FY 2014 and \$ 35.1 million in the first half of FY 2015. (*Id.* (citing CX-2587C)). The figures are broken down on per-patent basis, as is reflected in CX-2587C, above. From FY 2012 through the first half of FY 2015, Cisco invested approximately \$143.5 million in the '577 patent, \$143.5 million in the '853 patent, \$140.2 in the '875 patent, \$89.8 million in the '668 patent, \$140.2 million in the '492 patent, and \$129.9 million in the '211 patent. (*Id.*).

As Cisco noted, Cisco's U.S. investments in its plant and equipment across its DI Products were a greater percentage of its worldwide investments than its non-U.S. investments for each of the years shown. (*Id.* at 121 (citing Tr. (Leonard) at 2196:15-23)). By any measure, even with disparities between Mr. Sacks' and Dr. Leonard's calculations, Cisco's investments in

Public Version

plant and equipment are “significant” both qualitatively and quantitatively. *See Lelo*, 786 F.3d at 883.

3. Cisco’s Investments Under 19 U.S.C. § 1337(a)(3)(B)

Cisco has provided considerable evidence in support of its investments in the employment of labor or capital as apportioned to its DI Products. 19 U.S.C. § 1337(a)(3)(B). According to its expenditure figures, Cisco invested more than \$595 million in the employment of labor or capital in the United States for the DI Products from FY 2012 through the first half of FY 2015. (CX-2590C.). This figure translates into \$138.2 million in FY 2012, \$124.8 million in FY 2013, \$171 million in FY 2014 and \$161 million in the first half of FY 2015. (CBr. at 121 (citing CX-2590C).). On a per-DI Product basis, Cisco’s investments by each fiscal year are shown below:

Cisco’s Investments in Plant and Equipment for the DI Products in the U.S.

FY 2012 - FY 2015

<u>Asserted U.S. Patent No.</u>	<u>FY 2012</u>	<u>FY 2013</u>	<u>FY 2014</u>	<u>FY 2015</u>	<u>FY 2012 - FY 2015</u>
(a)	(b)	(c)	(d)	(e)	(f)
6,377,577	\$ 120,602,780	\$ 111,123,710	\$ 161,455,669	\$ 154,198,379	\$ 547,380,538
7,023,853	120,602,780	111,123,710	161,455,669	154,198,379	547,380,538
7,061,875	131,763,411	122,917,141	156,494,396	124,902,357	536,077,304
7,224,668	87,671,605	77,391,679	72,564,245	48,797,919	286,425,447
7,460,492	131,763,411	122,917,141	156,494,396	124,902,357	536,077,304
8,051,211	120,602,780	110,042,241	138,017,465	113,039,124	481,701,610

<u>Cisco Business Unit</u>	<u>Cisco Domestic Industry Products</u>	<u>FY 2012 (\$)</u>	<u>FY 2013 (\$)</u>	<u>FY 2014 (\$)</u>	<u>FY 2015 (\$)</u>
Unified Access (UABU)	Catalyst 4500 Switch	10,120,276	11,267,875	8,435,653	6,440,193
Enterprise Backbone (EBBU)	Catalyst 6500 Switch	41,275,095	23,159,095	24,627,354	17,796,447
Insieme (INSBU)	Nexus 3000 Switch	(9,962)	(394,386)	38,448,559	42,747,798
	Nexus 9000 Switch	0	0	13,607,021	35,765,232
Server Access & Virtualization (SAVBU)	Nexus 4000 Switch	1,040,355	525,556	210,095	29,017
	Nexus 5000 Switch	39,418,603	34,916,243	27,952,470	21,839,382
	Nexus 6000 Switch	0	1,081,468	9,831,184	5,394,023
Enterprise Core (ECBU)	Nexus 7000 Switch	39,919,044	52,361,288	46,989,081	30,655,496
Edge Routing (ERBU)	Cisco 12000 Router	6,477,466	1,871,295	947,809	345,976

(CX-2591C; CBr. at Attach. H (citing CX-2590C).).

As reflected in CX-2591C, above, from FY 2012 through the first half of FY 2015, Cisco invested in employment of labor or capital some \$547 million in the '577 patent, \$547 million in the '853 patent, \$536 million in the '875 patent, \$286.4 million in the '668 patent, \$536 million in the '492 patent, and \$481.7 million in the '211 patent. (CX-2591C). Consistently for these years, Cisco's U.S. investments for labor or capital across the DI Products were a greater percentage of worldwide investments than for non-U.S. investments. (Tr. (Leonard) at 2199:7-17.).

XI. WAIVER OR WITHDRAWAL OF ARISTA'S OTHER DEFENSES

Respondent's Response to the Complaint and Notice of Investigation contains a number of defenses and arguments that were not raised in Respondents' pre-hearing briefing, discussed at the hearing, or raised in post-hearing briefing ("non-asserted defenses"). The non-asserted defenses for which Arista provided no evidence include: (1) patent misuse; (2) Arista's importations for, sales to, and inventory for the United States government are outside the scope of this proceeding; (3) relief sought by Cisco is not in the public interest; (4) inequitable conduct; and (5) prior authorized sale and/or exhaustion. (*See* Arista's Response to Complaint and Notice of Investigation at 36-39, dated Feb. 11, 2015.).

Arista alleged in its Response to the Complaint and Pre-Hearing Brief that Cisco should be barred from asserting that Arista infringes the '668 patent based on the defense of patent misuse but failed to raise this contention in its initial Post-Hearing or Post-Hearing Reply Briefs. (Resp. at p. 36, ¶ 16; *id.* at p. 38 at ¶ 22; RPBr. at 127; RBr. at 55-69; RPBr. at 36-46.).

Accordingly, under Ground Rule 15.1.1, any arguments on this issue are deemed waived. (*See* G.R. 15.1.1.).

Public Version

The remaining non-asserted defenses were raised in Arista's Response to the Complaint but were not asserted in either Arista's Pre-Hearing or Initial Post-Hearing Briefs. (Resp. at pp. 36-39, ¶¶ 16-27.). Therefore, under Ground Rules 11.2 and 15.1., these defenses are deemed abandoned, withdrawn, or waived. (See Ground Rules 11.2, 15.1.1.).

XII. CONCLUSIONS OF LAW

1. The Commission has personal jurisdiction over the parties and subject matter and *in rem* jurisdiction over the Accused Products.
2. The Accused Products have been imported into the United States.
3. Cisco has proven by a preponderance of the evidence that the Accused Products infringe asserted claims 1, 7, 9, 10, and 15 of U.S. Patent No. 6,377,577; and asserted claims 1, 2, 4, 5, 7, 8, 10, 13, 18, 56, and 64 of U.S. Patent No. 7,224,668.
4. Cisco has not proven by a preponderance of the evidence that the Accused Products infringe asserted claim 2 of U.S. Patent No. 6,377,577; asserted claims 46 and 63 of U.S. Patent No. 7,023,853; asserted claims 1-4 and 10 of U.S. Patent No. 7,061,875; asserted claims 1, 3, and 4 of U.S. Patent No. 7,460,492; and asserted claims 2, 6, 13, and 17 of U.S. Patent No. 8,051,211.
5. Arista has not proven by clear and convincing evidence that any of the asserted claims of the patents-in-suit are invalid.
6. Arista has not proven by clear and convincing evidence that Cisco's patent claims are barred by equitable estoppel, waiver, implied license, laches, unclean hands, and patent misuse.
7. Cisco has proven that Arisa is barred from asserting the invalidity of U.S. Patent No. 6,377,577 because of the doctrine of assignor estoppel.
8. Cisco has proven that it has met the economic domestic industry requirement with regard to U.S. Patent No. 6,377,577 and U.S. Patent No. 7,224,668, the infringed patents-in-suit.
9. Cisco has proven that Arista has violated Section 337 of the Tariff Act of 1930, as amended.

This Initial Determination's failure to discuss any matter raised by the parties, or any portion of the record, does not indicate that it has not been considered. Rather, any such

Public Version

matter(s) or portion(s) of the record has/have been determined to be irrelevant, immaterial or meritless. Arguments made on brief which were otherwise unsupported by record evidence or legal precedent have been accorded no weight.

XIII. INITIAL DETERMINATION AND ORDER

Based on the foregoing, it is my Initial Determination on Violation of Section 337 that Arista Networks, Inc. has violated Section 337 of the Tariff Act of 1930, as amended, by importing into the United States, selling for importation, or selling within the United States after importation certain network devices, related software, and components thereof, by reason of infringement of claims 1, 7, 9-10, and 15 of United States Patent No. 6,377,577.

It is my Initial Determination on Violation of Section 337 that Arista Networks, Inc. has violated Section 337 of the Tariff Act of 1930, as amended, by importing into the United States, selling for importation, or selling within the United States after importation certain network devices, related software, and components thereof, by reason of infringement of claims 2, 4, 5, 7, 8, 10, 13, 18, 56, and 64 of United States Patent No. 7,224,668.

The undersigned hereby certifies to the Commission this Initial Determination. All orders and documents, filed with the Secretary, including the exhibit lists enumerating the exhibits received into evidence in this Investigation, that are part of the record, as defined in 19 C.F.R. § 210.38(a), are not certified, since they are already in the Commission's possession in accordance with Commission Rules. *See* 19 C.F.R. § 210.38(a). In accordance with 19 C.F.R. § 210.39(c), any material found to be confidential by the undersigned under 19 C.F.R. § 210.5 is to be given *in camera* treatment.

After the parties have provided proposed redactions of confidential business information ("CBI") that have been evaluated and accepted, the Secretary shall serve a public version of this

Public Version

ID upon all parties of record. The Secretary shall serve a confidential version upon counsel who are signatories to the Protective Order (Order No. 1) issued in this Investigation.

Pursuant to 19 C.F.R. § 210.42(h), this Initial Determination shall become the determination of the Commission unless a party files a petition for review pursuant to 19 C.F.R. § 210.43(a) or the Commission, pursuant to 19 C.F.R. § 210.44, orders on its own motion a review of the Initial Determination or certain issues therein.

RECOMMENDED DETERMINATION ON REMEDY AND BOND

XIV. REMEDY AND BONDING

The Commission's Rules provide that subsequent to an Initial Determination on the question of violation of Section 337 of the Tariff Act of 1930, as amended, 19 U.S.C. § 1337, the Administrative Law Judge shall issue a recommended determination containing findings of fact and recommendations concerning: (1) the appropriate remedy in the event that the Commission finds a violation of Section 337; and (2) the amount of bond to be posted by respondents during Presidential review of Commission action under Section 337(j). *See* 19 C.F.R. § 210.42(a)(1)(ii).

This decision recommends: (1) a limited exclusion order with a certification provision; (2) a cease and desist order, but with a carve out for certain Arista products; and (3) that a bond of 5% based on industry averages be issued for the Presidential Review Period.

A. Limited Exclusion Order

The Commission may issue a remedial order excluding the goods of respondents found in violation of Section 337 (a limited exclusion order) or, if certain criteria are met, excluding all infringing goods regardless of the source (a general exclusion order). 19 U.S.C. § 1337(d); *Certain Hydraulic Excavators and Components Thereof*, Inv. No. 337-TA-582, Comm'n Op. at

Public Version

15 (U.S.I.T.C. February 3, 2009) (“Certain Excavators”). The Commission has “broad discretion in selecting the form, scope and extent of the remedy.” *Viscofan, S.A. v. U.S. Int’l Trade Comm’n*, 787 F.2d 544, 548 (Fed. Cir. 1986). Here, Complainant has requested a limited exclusion order (“LEO”). (CBr. at 123.). A LEO instructs the U.S. Customs and Border Protection (“Customs”) to exclude from entry all articles that are covered by the patents at issue and that originate from a named respondent in the investigation. *See* 19 U.S.C. § 1337(d); *Fuji Photo Film Co., Ltd. v. Int’l Trade Comm’n*, 474 F.3d 1281, 1286 (Fed. Cir. 2007).

Cisco has argued that because of Arista’s Section 337 violation through their importation of infringing networking equipment, the components and software therein (such as switches and their components), operating systems and /or other software, and “all products covered by the patent claims as to which a violation has been found,” and not merely the accused models, the Commission should issue a LEO against any such product imported by or on behalf of Arista and their affiliated business companies and their successors and assigns. (CBr. at 123 (quoting *Certain Hardware Logic Emulation Sys.*, Inv. No. 337-TA-383, Comm’n Op. at 16 (U.S.I.T.C. Mar. 1, 1998); *Certain Semiconductor Chips with Minimized Package Size*, Inv. No. 337-TA-605, Initial Determination at 71 (U.S.I.T.C. Dec. 1, 2008)).). Cisco contended there should not be a carve-out for replacement parts because other industry participants, including Cisco, can supply such parts to Arista’s customers. (CBr. at 123; *see also* CPBr. at 196 (citing Vander Veen Dep. Tr. at 50:15–51:10)). *See e.g.*, *Certain Agric. Tractors Under 50 Power Take-Off Horsepower*, Inv. No. 337-TA-380, Comm’n Op. at 29 (U.S.I.T.C. Mar. 12, 1997).

Arista argued that any LEO remedy should be narrowly tailored to address any specific

Public Version

unfair acts without disrupting “legitimate commerce.”¹⁵⁴ (RBr. at 124 (citing *Certain Flash Memory Circuits*, USITC Pub. 23046, Inv. No. 337-TA-382, Comm’n Op. at 18 (Pub. Version) (July 1997)). Arista has asked for an exception that would permit Arista’s service and warranty support for its existing customers, noting case law that supports the balancing of public interests to include the needs of consumers who need repairs and replacements to existing devices. (*Id.* (citing *Certain Digital Models*, Inv. No. 337-TA-833, Comm’n Op. at 151 (Pub. Version) (U.S.I.T.C. Apr. 9, 2014)).

Arista introduced evidence that it provides service and warranty support for existing customers [] (*Id.* (citing Tr. (Sadana) at 2130:21–2131:17; RX-1365 (Product Warranty); RX-1366 (A-Care); RX-1377 (Master Services Agreement)). [] (*Id.* (citing Tr. (Metivier) at 2076:15–2077:25; RX-0038C (Appendix E-3)). Additionally, [] (*Id.* at 124-25 (citing Tr. (Sadana) at 2130:21–2131:7)).

Arista made two (2) arguments with respect to the availability of other commercially available products to its clients: (1) that because its customers have specific requirements for how Arista products must interoperate with other network elements and be certified for use in specific, client-based infrastructures, those customers would face significant “burden, expense and business disruption,” if a carve out is not granted; and (2) there are no other commercially available replacement parts. (*Id.* at 125 (citing Tr. (Sadana) at 2133:23–2134:5)).

¹⁵⁴ Arista’s argument might be interpreted as inherently a “public interest” argument, although it was not styled that way.

Public Version

Staff recommended that a limited exclusion order is warranted, at least with respect to the '668 patent.¹⁵⁵ (SBr. at 88.).

If the Commission affirms this Initial Determination that Arista has violated Section 337 with respect to the asserted '668 and '577 patents, it is the recommendation of this Initial Determination that the Commission issue an LEO. The LEO should apply to Arista and to all of their affiliated companies, parents, subsidiaries, or other related business entities, or its successors or assigns,¹⁵⁶ and should prohibit the unlicensed entry of all of Arista's accused products that infringe the claims of the '668 and '577 patents. However, it is recommended there be a "carve out" for those products that Arista services through warranties and its replacement services. Cisco did not provide evidence as to how it could or would service the Arista customers who have relied upon Arista's infringing products.

Arista was the only party who addressed whether there is a need for a certification provision, and advocated that one be ordered. (RPBr. at 199.). Certification provisions have been included in previous exclusion orders where parties, as here, import both infringing and non-infringing products. *See Certain Condensers, Parts Thereof and Prods. Containing Same, Including Air Conditioners for Automobiles*, Inv. No. 337-TA-334 (Remand), Comm'n Op. at 39 (U.S.I.T.C. Sept. 10, 1997) (recognizing that "certification provisions have been included in previous exclusion orders where respondents imported both infringing and non-infringing products"). Arista suggested that a certification provision is included when Customs will be unable to determine easily whether a product is within the scope of an exclusion order through

¹⁵⁵ The Staff's position is that only the '668 patent is infringed. (SBr. at 24-29.). However, this decision also finds that the '577 patent is infringed.

¹⁵⁶ This recommendation is not intended to bypass the decision in *Kyocera Wireless Corp. v. Int'l Trade Comm'n*, 545 F.3d 1340, 1358 (Fed. Cir. 2013), but instead is standard language taken from a limited exclusion order.

Public Version

visual inspection. (RPBr. at 199 (citing *Certain Semiconductor Chips with Minimized Chip Package Size*, Inv. No. 337-TA-605, Comm'n Op. at 72 (Pub. Version) (U.S.I.T.C. June 3, 2009) ("*Certain Semiconductor Chips*").)

Given the potential difficulty for Customs to be able to distinguish one Arista product from another, a certification provision in an LEO seems both reasonable and necessary.

B. Cease and Desist Order

Section 337 provides that in addition to, or in lieu of, the issuance of an exclusion order, the Commission may issue a cease and desist order ("CDO") as a remedy for violation of Section 337. *See* 19 U.S.C. § 1337(f)(1). The Commission generally issues a CDO directed to a domestic respondent when there is a "commercially significant" amount of infringing, imported product in the United States that could be sold so as to undercut the remedy provided by an exclusion order. *See Certain Crystalline Cefadroxil Monohydrate*, Inv. No. 337-TA-293, Comm'n Op. on the Issue Under Review, and on Remedy, the Public Interest and Bonding, Pub. No. 2391, 0091 WL 11732562, at *27 (U.S.I.T.C. June 1991). Cease and desist orders have been declined when the record contains no evidence concerning infringing inventories in the United States. *Certain Condensers, Parts Thereof and Prods. Containing Same, Including Air Conditioners for Automobiles*, Inv. No. 337-TA-334 (Remand), Comm'n Op. at 28 (U.S.I.T.C. Sept. 10, 1997).

Cisco has argued that the Commission should issue a permanent cease and desist order against Arista because Arista maintains significant inventory in the United States. (CBr. at 124.). *See, e.g., Certain Agric. Vehicles and Components Thereof*, Inv. No. 337-TA-487, Comm'n Op. on Remedy, the Public Interest, and Bonding at 13 (U.S.I.T.C. Sept. 24, 2004). According to the evidence presented in this Investigation, [

] in the United States. (CBr. at 124

(citing CX-2603C; CX-0734C).). Cisco argued for a detailed CDO that would prohibit Arista from:

(1) importing or selling for importation products covered by any Asserted Patent, and components thereof, including by way of electronic transmissions into and out of the U.S.; (2) marketing, distributing, offering for sale, selling, or otherwise transferring (except for exportation) imported products covered by any Asserted Patent, and components thereof; (3) advertising imported products covered by any Asserted Patent, and components thereof; (4) soliciting U.S. agents or distributors for imported products covered by one or more of the Asserted Patents, and components thereof; or (5) aiding or abetting others in the importation, sale for or after importation, transfer, or distribution of products covered by any Asserted Patent, and components thereof.

(*Id.* (citing *Certain Coupler Devices for Power Supply Facilities*, Inv. No. 337-TA-590, Comm'n Op. at 2-3 (U.S.I.T.C. Dec. 20, 2007).).

Staff agreed with Cisco's position, generally, but without taking a specific position on the tailoring of content of the CDO. (SPBr. at 151 (citing Leonard Report ¶¶ 80-81); SBr. at 89 (citing Tr. (Leonard) at 2203:16–2206:8; CX-0734C at CSI-ANI-00685633 and Appendices referenced (Arista interrogatory response setting forth inventory); CX-2603C (Dr. Leonard's summary of inventory)).).

Arista did not take either an explicit pre-hearing or post-hearing position on this issue. (RPBr. at 198-200; RBr. at 124-26.). Consequently, Arista waived any argument it may have had with respect to this issue. (*See* G.R. 11.2, 15.1.1.).

C. Bond During the Presidential Review Period

The Administrative Law Judge and the Commission must determine whether a bond will issue and the amount of a bond to be required of a respondent, pursuant to Section 337(j)(3), during the 60-day Presidential review period following the issuance of permanent relief, in the

Public Version

event that the Commission determines to issue a remedy. 19 C.F.R. § 210.42(a)(1)(ii). The purpose of the bond is to protect the complainant from any injury. 19 C.F.R. § 210.50(a)(3).

When reliable price information is available, the Commission has often set the bond by eliminating the differential between the domestic product and the imported, infringing product. *See Certain Microsphere Adhesives, Process for Making Same, and Prods. Containing Same, Including Self-Stick Repositionable Notes*, Inv. No. 337-TA-366, Comm'n Op. at 24, 1996 WL 1056298 (U.S.I.T.C. January 1996). In circumstances where pricing information is unclear, or where variations in pricing make price comparisons complicated and difficult, the Commission typically has set a 100 percent bond. *Id.* at 24-25; *Certain Digital Multimeters and Prods. with Multimeter Functionality*, Inv. No. 337-TA-588, Comm'n Op. at 12-13 (U.S.I.T.C. June 3, 2008) (finding 100 percent bond where each respondent set its price differently, preventing clear differentials between complainant's products and the infringing imports). When a pricing comparison is impossible, it is also appropriate to set the bond based on a reasonable royalty. *Certain Digital Televisions and Certain Prods. Containing Same and Methods of Using Same*, Inv. No. 337-TA-617, Comm'n Op. at 18 (U.S.I.T.C. Apr. 23, 2009).

Respondents' contention that a product-to-product price comparison is not feasible is unpersuasive and not supported by the law. *See, e.g., Certain LED Photographic Lighting Devices and Components Thereof*, Inv. No. 337-TA-804, Comm'n Op. at 34 (U.S.I.T.C. Feb. 28, 2013) (determining the price differential and bond rate based on the prices at which the respondents' and complainants' products were being sold); *Certain Protective Cases and Components Thereof*, Inv. No. 337-TA-780, Comm'n Op. at 2, 31-33 (U.S.I.T.C. Nov. 19, 2012) (determining the price differential and bond rate based on the prices at which the respondents' and complainants' products were being sold).

Public Version

Cisco advocates for a bond during the Presidential Review Period based on the evidence that Cisco and Arista are direct competitors, and its claims that Arista “attempted to increase its sales at the expense of its competitors—including Cisco.” (CBr. at 124 (citing Tr. (Sadana) at 2118:20–2119:9; 2148:23–2150:13; Tr. (Vander Veen) at 2310:20–2311:24; Tr. (Jiandani) 1126:6-12).). Dr. Vander Veen conceded that Arista could take sales away from Cisco during the Presidential Review period. (Tr. (Vander Veen) at 2312:20–2313:4.). However, Cisco itself conceded that there is “no established or reasonable royalty for the Asserted Patents that could be used to calculate the bond.” (CBr. at 124-25.). Cisco also conceded that Arista offered no agreements that would assist in pricing a bond; neither is there any evidence of a positive price differential between Cisco’s DI Products and Arista’s products. (*Id.* at 125 (citing Tr. (Leonard) at 2207:8–2209:13.).). At best, Cisco’s expert offered only conclusory statements with regard to why he believes a price differential approach could not be used. (*Id.*). Nonetheless, without carrying its burden of proof on the issue of a bond, Cisco nonetheless argued that a 100% bond is in order to “offset any competitive advantage resulting from the unfair method of competition or unfair act” by Arista.” (CPBr. at 197; CBr. at 124 (quoting *Certain Dynamic Random Access Memories*, Inv. No. 337-TA-242, Comm’n Op. at 94 (Pub. Version) (U.S.I.T.C. Nov. 3, 2004.).).

Arista has argued that no bond should be set, but if a bond is set, it should be no more than 5%. (RPBr. at 200; RBr. at 125-26).

Staff noted that there was a sufficient quantum of evidence presented during the hearing from both Cisco and Arista witnesses that information might have been available to support a price differential analysis, but no such analysis was actually performed. (SBr. at 90 (citing Tr. (Jiandani) at 1126:6-12 (Arista is a direct competitor of Cisco’s); *id.* at 2107:9-13, 2107:22-25 (Arista “commands a 20 to 40 percent premium” over Cisco’s pricing), 2117:7-18 (identifying

Public Version

Cisco products that compete with Arista's); Tr. (Edsall) at 713:7-11 (identifying Cisco and Arista products that compete in the data center market).).

In this case, given the potential competitive effects of Arista's infringing products on Cisco, it is recommended that a 5% bond based on industry averages is appropriate. (See Tr. (Vander Veen) at 2295:2-22; RDX-8023; RX-1272 through RX-1281; *Certain Semiconductor Chips* at 72 (setting bond at 3.5% based on median royalty rate in the industry).

XV. CONCLUSION

For the reasons set forth above, the weight of the evidence supports a finding that there has been a violation of Section 337 because of infringement of certain asserted claims of the '668 and '577 patents. The evidence presented by Cisco also supports a finding that the technical and economic prongs of the domestic industry requirements are satisfied for the '668 and '577 patents. However, Arista did not prove by clear and convincing evidence that these two patents are invalid or unenforceable.

Because of Arista's significant inventory in the United States as of May 2015, a limited exclusion order with a carve-out provision for the products Arista warranties or services is recommended. A cease and desist order is recommended. Finally, a 5% bond using industry averages is recommended during the Presidential Review Period because of Arista's significant position in the market, and the potential impacts of its products on Cisco.

Within fourteen (14) days of the date of this document, each party shall submit to the Office of Administrative Law Judges a joint statement regarding whether or not they seek to have any portion of this document deleted from the public version. The parties' submission shall be made by hard copy and must include a copy of this Initial Determination on Violation with red brackets indicating any portion asserted to contain CBI to be deleted from the public version.

Public Version

The parties' submission shall also include an index identifying the pages of this document where proposed redactions are located. The parties' submission concerning the public version of this document need not be filed with the Commission Secretary.

SO ORDERED.



MaryJoan McNamara
Administrative Law Judge

APPENDIX A

Agreed Upon and Construed Claim Constructions

I. Claim Constructions of the '577 and '853 Patents

A. Agreed Terms

Term(s)	Agreed Construction
Preamble, '577 patent, claim 1	The parties agreed, and it has been construed, that the preamble is not limiting to the extent the preamble is "A method including the steps of." To the extent the preamble also includes, "maintaining a set of access control patterns in at least one associative memory," the preamble is limiting. (<i>Markman</i> Order at 12.).
"A method, including the steps of maintaining a set of access control patterns in at least one associative memory"	The parties agreed, and it has been construed, that "A method, including the steps of maintaining a set of access control patterns in at least one associative memory," as it is used in the '577 patent need no further construction, given the previously-agreed constructions of "access control patterns" and "associative memory," as well as the parties agreed-upon views as to the preamble. (SBr. at 5; CBr.II., Attach. I at 6.).
"associative memory"	The parties agreed, and it has been construed, that "associative memory," as it is used in the '577 and '853 patents has its plain and ordinary meaning. (<i>Markman</i> Order at 12.).
"a hardware content-associative memory"	The parties agreed, and it has been construed, that "hardware content-associative memory," as it is used in the '577 patent means "a content addressable memory." (SBr. at 5; CBr.II, Attach. I at 7.).
"ternary content-associative memory"	The parties agreed, and it has been construed, that "ternary content-associative memory," as it is used in the '577 patent means "a ternary content addressable memory." (<i>Markman</i> Order at 12.).
"access control"	The parties agreed, and it has been construed, that "access control," as it is used in the '577 and '853 patents has its plain and ordinary meaning. (<i>Markman</i> Order at 12.).

Public Version

“matchable information”	The parties agreed, and it has been construed, that “matchable information,” as it is used in the ’577 and ’853 patents has its plain and ordinary meaning. (<i>Markman</i> Order at 12.).
“said packet label being sufficient to perform access control processing for said packet”	The parties agreed, and it has been construed, that “said packet label being sufficient to perform access control processing for said packet,” as it is used in the ’853 patent has its plain and ordinary meaning. (<i>Markman</i> Order at 12.).
“forwarding permission”	The parties agreed, and it has been construed, that “forwarding permission,” as it is used in the ’853 patent has its plain and ordinary meaning. (<i>Markman</i> Order at 12.).

B. Construed Terms

Term(s)	Construed Construction
Claims 1 and 9 of the ’577 Patent; Claim 46 of the ’853 Patent— <i>“responsive to”</i>	“Responsive to” has been construed to have its plain and ordinary meaning, including, but not limited to, “based on” or “derived from.” (<i>Markman</i> Order at 20; Complainant’s Opening Claim Construction Br. at 14 (May 15, 2015); Respondent’s Initial Claim Construction Br. at 8 (May 15, 2015); Staff’s Initial Claim Construction Br. at 9 (May 22, 2015).).
Claim 63— <i>“access control specifier”</i>	“Access control specifier” has been construed to mean “a specifier that includes information for matching with a packet and that may indicate, or aid in indicating, an access result.” (<i>Markman</i> Order at 32.).

II. Claim Constructions of the ’875 and ’492 Patents

A. Agreed Terms

Term(s)	Agreed Construction
Preamble, ’492 Patent, Claim 1; ’875 Patent, Claims 1, 10	The parties agreed, and it was construed, that the preamble is limiting. (<i>Markman</i> Order at 37.).

Public Version

<p>'492 Patent, Claim 1; '875 Patent; Claim 10—“<i>the loop guard engine to cooperate with the spanning tree protocol engine</i>”/“<i>loop guard engine cooperating with the STP engine</i>”</p>	<p>The parties agreed, and it was construed, that “loop guard engine cooperating with the STP engine,” as it is used in the '492 and '875 patents, means “the loop guard engine in a communicating relationship with other elements of the spanning tree protocol engine.” (SBr. at 62; CBr., Attach. A at 3.).</p>
--	---

B. Construed Terms

Term(s)	Construed Construction
<p>'492 Patent, Claim 1; '875 Patent, Claims 1, 10—“<i>a discarding [port] state</i>”/“<i>a discarding or blocking state</i>”</p>	<p>“[A] discarding state,” “a discarding port state,” and “a discarding or blocking state,” as construed, mean “a port state in a spanning tree protocol or algorithm in which data frames are neither forwarded to nor received from the port.” (<i>Markman</i> Order at 42.).</p>
<p>'492 Patent, Claim 1; '875 Patent, Claims 1, 10—“<i>a listening [port] state</i>”</p>	<p>“[A] listening [port] state,” as construed, means “a port state in a spanning tree protocol or algorithm in which a port waits for information to determine whether to return to the blocking state or to transition to a state in which location information corresponding to received frames is stored.” (<i>Markman</i> Order at 46.).</p>
<p>'492 Patent, Claim 1; '875 Patent, Claims 1, 10—“<i>a forwarding [port] state</i>”</p>	<p>“[A] forwarding [port] state,” as construed, means “a port state in a spanning tree protocol or algorithm in which data frames may be forwarded to and from the port.” (<i>Markman</i> Order at 48.).</p>

III. Claim Constructions of the '668 Patent

A. Agreed Terms

Term(s)	Agreed Construction
<p>Claim 3—“<i>information implicit to the packets</i>”</p>	<p>The parties agreed, and it has been construed, that “information implicit to the packets,” as it is used in the '668 patent, should have its plain and ordinary meaning. (<i>Markman</i> Order at 52.).</p>

B. Construed Terms

Term(s)	Construed Construction
Claim 1— <i>“specific, predetermined physical ports”</i>	“Specific, predetermined physical ports” does not require construction and should have its plain and ordinary meaning. ¹⁵⁷ (<i>Markman</i> Order at 59).
Claim 1— <i>“independent of the physical port interfaces and services applied thereto”/“independent of the individual physical port interface configuration and port services applied thereto”</i>	“Independent of the physical port interfaces and services applied thereto” and “independent of the individual physical port interface configuration and port services applied thereto” have their plain and ordinary meanings. (<i>Markman</i> Order at 63).

IV. Claim Constructions of the ’211 Patent

A. Agreed Construction

Term(s)	Agreed Construction
“LAN”	The parties agreed, and it was construed, that “LAN” means “a physical connection to a host, or to a network device connected to a host.” (<i>Markman</i> Order at 67.).
“host”	The parties agreed, and it was construed, that “host” means “an end station, which is the source of, or destination of, frames transmitted over a network.” (<i>Markman</i> Order at 67.).
“intermediate device”	The parties agreed, and it was construed, that “intermediate device” means “a device used to interconnect LANs and/or other types of transmission media, such as a bridge, router, or switch.” (<i>Markman</i> Order at 67.).
“intermediate network device”	The parties agreed, and it was construed, that “intermediate network device” means “a device used to interconnect LANs and/or other types of transmission

¹⁵⁷ Under the broadest reasonable interpretation of “specific, predetermined ports,” the PTAB construed the term to “encompass[] all ports of the networking device, and is not limited to a subset of the ports.” (IPR2016-00309, Paper 8 at 8 (June 11, 2016)).

Public Version

	media, such as a bridge, router, or switch.” (<i>Markman</i> Order at 67.).
--	--

B. Construed Terms

Term(s)	Construed Construction
Claims 1, 12—“aggregating” and “aggregate”	“[A]ggregating,” as construed, means “grouping multiple LANs into a single logical link.” By the same token, to “aggregate” means to “group multiple LANs into a single logical link.” (<i>Markman</i> Order at 71.).
Claims 2, 13—“tunneling said first LAN with a third LAN through said first intermediate network device” and “tunnel said first LAN with a third LAN through said first intermediate network device”	“[T]unneling,” as construed, means “transmitting a frame without examination.” “Tunnel” means “transmit a frame without examination.” ¹⁵⁸ (<i>Markman</i> Order at 75.). The individual words “said first LAN with a third LAN through said first intermediate network device” have their plain and ordinary meanings. (<i>Id.</i>). The combined language “tunneling said first LAN with a third LAN through said first intermediate network device”/“tunnel said first LAN with a third LAN through said first intermediate network device” is construed to mean that the first intermediate device would be configured to internally transmit, without examination, frames between the first LAN and a third LAN. (<i>Id.</i>).

¹⁵⁸ Under the broadest reasonable interpretation of the term “tunneling,” the PTAB has construed this term to mean “transmitting a frame without examination, including in layer 2 and layer 3 communications.” (*See* IPR2015-00975, Paper 36 at 10 (Oct. 5, 2016).).

APPENDIX B

Arista's Products Subject to the Limited Exclusion Order¹⁵⁹

<u>'668 Patent, Claim 1</u>	<u>'668 Patent, Claim 2</u>	<u>'668 Patent, Claim 4</u>	<u>'668 Patent, Claim 5</u>	<u>'668 Patent, Claim 7</u>	<u>'668 Patent, Claim 8</u>	<u>'668 Patent, Claim 10</u>	<u>'668 Patent, Claim 13</u>	<u>'668 Patent, Claim 18</u>	<u>'668 Patent, Claim 56</u>	<u>'668 Patent, Claim 64</u>
<u>Accused Products:</u> 7010 Series, 7048 Series, 7050 Series, 7050X Series, 7150 Series, 7250X Series, 7280E Series, 7300 Series, 7500E Series	<u>Accused Products:</u> 7010 Series, 7048 Series, 7050 Series, 7050X Series, 7150 Series, 7250X Series, 7280E Series, 7300 Series, 7500E Series	<u>Accused Products:</u> 7010 Series, 7048 Series, 7050 Series, 7050X Series, 7150 Series, 7250X Series, 7280E Series, 7300 Series, 7500E Series	<u>Accused Products:</u> 7010 Series, 7048 Series, 7050 Series, 7050X Series, 7150 Series, 7250X Series, 7280E Series, 7300 Series, 7500E Series	<u>Accused Products:</u> 7300 Series, 7500E Series	<u>Accused Products:</u> 7010 Series, 7048 Series, 7050 Series, 7050X Series, 7150 Series, 7250X Series, 7280E Series, 7300 Series, 7500E Series	<u>Accused Products:</u> 7010 Series, 7048 Series, 7050 Series, 7050X Series, 7150 Series, 7250X Series, 7280E Series, 7300 Series, 7500E Series	<u>Accused Products:</u> 7010 Series, 7048 Series, 7050 Series, 7050X Series, 7150 Series, 7250X Series, 7280E Series, 7300 Series, 7500E Series	<u>Accused Products:</u> 7010 Series, 7048 Series, 7050 Series, 7050X Series, 7150 Series, 7250X Series, 7280E Series, 7300 Series, 7500E Series	<u>Accused Products:</u> 7010 Series, 7048 Series, 7050 Series, 7050X Series, 7150 Series, 7250X Series, 7280E Series, 7300 Series, 7500E Series	<u>Accused Products:</u> 7010 Series, 7048 Series, 7050 Series, 7050X Series, 7150 Series, 7250X Series, 7280E Series, 7300 Series, 7500E Series
<u>Infringement:</u> Literal Direct Induced Contributory	<u>Infringement:</u> Literal Direct Induced Contributory	<u>Infringement:</u> Literal Direct Induced Contributory	<u>Infringement:</u> Literal Direct Induced Contributory	<u>Infringement:</u> Literal Direct Induced Contributory	<u>Infringement:</u> Literal Direct Induced Contributory	<u>Infringement:</u> Literal Direct Induced Contributory	<u>Infringement:</u> Literal Direct Induced Contributory	<u>Infringement:</u> Literal Direct Induced Contributory	<u>Infringement:</u> Literal Direct Induced Contributory	<u>Infringement:</u> Literal Direct Induced Contributory

<u>'577 Patent, Claim 1</u>	<u>'577 Patent, Claim 2</u>	<u>'577 Patent, Claim 7</u>	<u>'577 Patent, Claim 9</u>	<u>'577 Patent, Claim 10</u>	<u>'577 Patent, Claim 15</u>
<u>Accused Products:</u> 7010 Series, 7048 Series, 7050 Series, 7050X Series, 7150 Series, 7250X Series, 7280E Series, 7300 Series, 7300X Series 7500E Series	<u>Accused Products:</u> 7010 Series, 7048 Series, 7050 Series, 7050X Series, 7150 Series, 7250X Series, 7280E Series, 7300 Series, 7300X Series 7500E Series	<u>Accused Products:</u> 7010 Series, 7048 Series, 7050 Series, 7050X Series, 7150 Series, 7250X Series, 7280E Series, 7300 Series, 7300X Series 7500E Series	<u>Accused Products:</u> 7010 Series, 7048 Series, 7050 Series, 7050X Series, 7150 Series, 7250X Series, 7280E Series, 7300 Series, 7300X Series 7500E Series	<u>Accused Products:</u> 7010 Series, 7048 Series, 7050 Series, 7050X Series, 7150 Series, 7250X Series, 7280E Series, 7300 Series, 7300X Series 7500E Series	<u>Accused Products:</u> 7010 Series, 7048 Series, 7050 Series, 7050X Series, 7150 Series, 7250X Series, 7280E Series, 7300 Series, 7300X Series 7500E Series
<u>Infringement:</u> Literal Direct Induced Contributory	<u>Infringement:</u> Literal Direct Induced Contributory	<u>Infringement:</u> Literal Direct Induced Contributory	<u>Infringement:</u> Literal Direct Induced Contributory	<u>Infringement:</u> Literal Direct Induced Contributory	<u>Infringement:</u> Literal Direct Induced Contributory

¹⁵⁹ CBr. at Attach. B; CBr.II at Attach. J.

**CERTAIN NETWORK DEVICES,
RELATED SOFTWARE AND
COMPONENTS THEREOF (II)**

337-TA-945

PUBLIC CERTIFICATE OF SERVICE

I, Lisa R. Barton, hereby certify that the attached **INITIAL DETERMINATION** has been served upon the Commission Investigative Attorney, Monica Bhattacharyya, Esq., and upon the following parties as indicated on **January 9, 2017**.

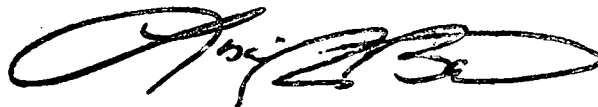

Lisa R. Barton
Secretary to the Commission
U.S. International Trade Commission
500 E Street, SW, Room 112A
Washington, D.C. 20436

ON BEHALF OF COMPLAINANT CISCO SYSTEMS, INC.:

D. Sean Trainor, Esq.
KIRKLAND & ELLIS LLP
655 15th Street N.W.
Washington, D.C. 20005
(202) 879-5000

- () Via Hand Delivery
() Via Express Delivery
() Via First Class Mail
() Other: _____

ON BEHALF OF RESPONDENT ARISTA NETWORKS, INC.:

Lauren A. Degnan, Esq.
FISH & RICHARDSON P.C.
1425 K Street, N.W., 11th Floor
Washington, D.C. 20005
(202) 783-5070

- () Via Hand Delivery
() Via Express Delivery
() Via First Class Mail
() Other: _____