

UNITED STATES INTERNATIONAL TRADE COMMISSION

1984 ANNUAL REPORT

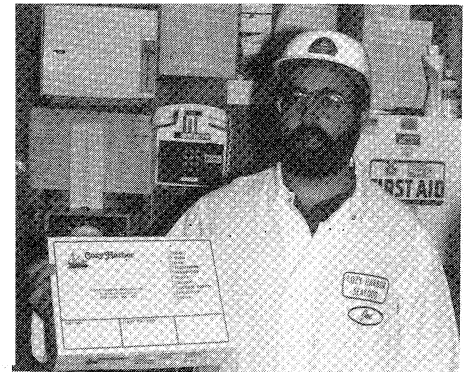
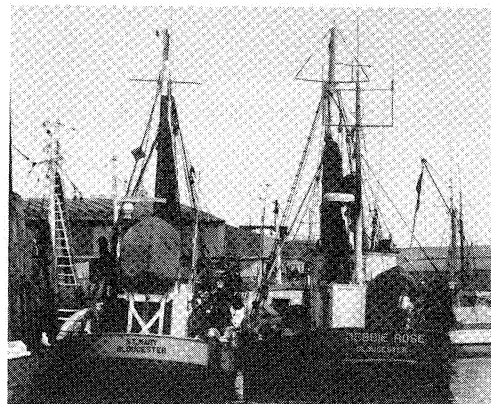
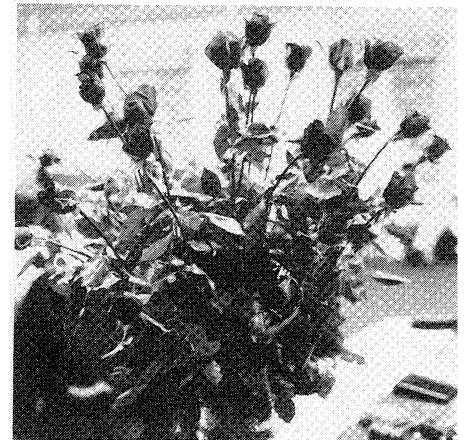
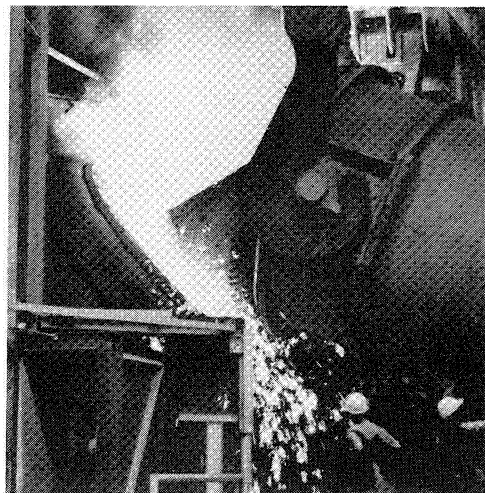
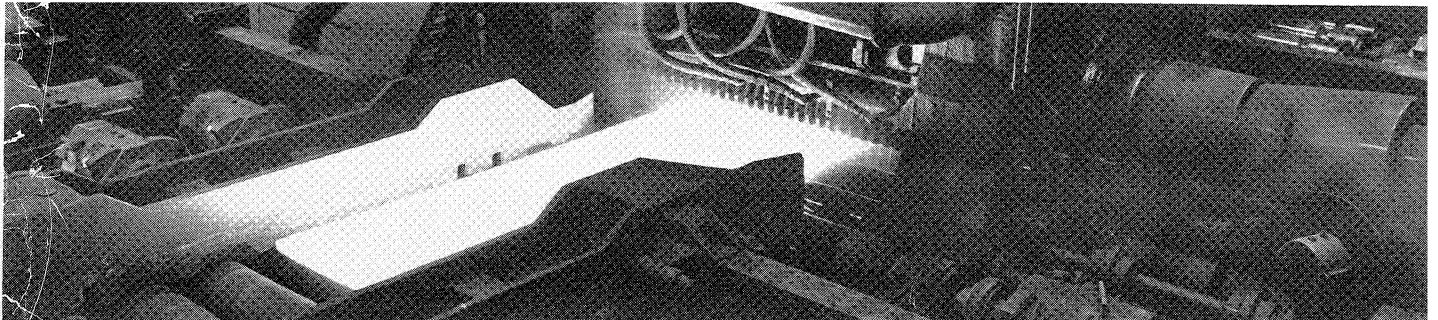

1984
Annual Report

United States International Trade Commission



Commissioners

Paula Stern, Chairwoman

Susan W. Liebeler, Vice Chairman

Alfred E. Eckes

Seeley G. Lodwick

David B. Rohr

Kenneth R. Mason
Secretary to the Commission

Address all communications to
United States International Trade Commission
Washington, DC 20436

USITC Publication 1718

Published by: Public and Consumer Affairs Office
Compiled by: Paulette Davis
Copy edited by: Eric Pargament

Photo Credits: Investigative
hearings: Hal Sundstrom and
Paulette Davis

For sale by the Superintendent of Documents
U.S. Government Printing Office
Washington, DC 20402

The Commission



Chairwoman Paula Stern, Democrat of the District of Columbia. Dr. Stern entered on duty on October 16, 1978. Her term expires on June 16, 1987.



Vice Chairman Susan W. Liebeler, Independent of California. Mrs. Liebeler entered on duty on April 20, 1984. Her term expires on December 16, 1988.



Commissioner Alfred E. Eckes, Republican of Virginia. Mr. Eckes entered on duty on September 21, 1981. His term expires on June 16, 1990.



Commissioner Seeley G. Lodwick, Republican of Iowa. Mr. Lodwick entered on duty on August 12, 1983. His term expires on December 16, 1991.

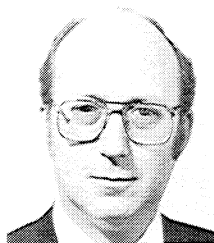

Commissioner David B. Rohr, Democrat of Maryland. Mr. Rohr entered on duty on March 27, 1984. His term expires on December 16, 1985.

Vacancy: The term expires on June 16, 1993.

Message From the Chairwoman

Fiscal year 1984 ended with the United States reporting the largest trade deficit in its history—\$123.3 billion. The consequences of the deficit were clearly apparent at the Commission. An almost constant stream of petitioners found their way to our doorstep, seeking relief from import competition. Industries that previously faced little or no serious threats from foreign competition suddenly found themselves turning to the Commission for relief. Petitioners ranged from traditional "smoke-stack" industries to the latest "high-tech" producers. An increasing number of complaints were also received from agricultural producers, signaling the advent of new trade pressures in that sector.

Several forces beyond our control contributed to our increased workload. The steep appreciation of the U.S. dollar during the year priced U.S. goods out of foreign markets and drew foreign products into U.S. markets. Underlying the high value of the dollar were fundamental shifts in the comparative advantage of many U.S. manufacturers. Firms in newly industrializing countries posed new challenges to many established U.S. industries.

The Commission's caseload reflected the broad nature of the international trade problem. Petitions increased this year under all our major statutes regardless of the "fair or unfair" status of the imports. "Escape-clause" cases, dumping and countervailing duty investigations, and

unfair import practices petitions all increased in fiscal year 1984. Only by pressing the abilities of our cadre of international trade professionals to the limit were we able to respond to the demands on our resources.

In fiscal year 1984, Congress reacted to our workload increases by authorizing 44 additional staff positions for fiscal year 1985, bringing the Commission's authorized strength to 482. As staffing levels were increased, an intensive recruiting effort was undertaken to find the best candidates available. The qualifications of our new employees, in terms of education and experience, ensure that the Commission tradition of quality output in a timely manner will continue.

This year at the Commission has been one of challenge and increased responsibility. Our caseload can be expected to increase, the challenge to continue, and our responsibilities to expand. The Commission's reputation for objective, quality fact-finding reports will put us in the forefront of the effort to better understand the complex forces driving international trading patterns.



Contents

Summary of activities	viii	Office of Tariff Affairs and Trade Agreements	23
Introduction to the USITC	ix	Office of Data Systems	26
Part I. Investigative highlights:			
Investigations under sections 201 and 203(i) of the Trade Act of 1974, the "escape clause"	1	Office of Congressional Liaison	26
"Market disruption" investigations	6	Office of the Secretary	27
Investigations under title VII of the Tariff Act of 1930:	6	Office of Administration	28
Antidumping investigations	6	Part III. Management and finance:	
Countervailing duty investigations	6	The Commission	30
Section 751 review investigations	7	Executive staff	31
Section 104(b) countervailing duty review investigations	7	Employment and appropriations	32
Section 22 investigations	10	Sources of information	34
Unfair import practice investigations	11	Appendix A. Summary of principal activities of the U.S. International Trade Commission, fiscal years 1981-84	36
Part II. Organizational activities:			
Office of Investigations	13	Appendix B. Summary of investigations completed during fiscal year 1984 and pending on September 30, 1984	37
Office of Industries	13	Appendix C. Reports submitted to Congress on proposed legislation	60
Investigations under section 332	15	Appendix D. Litigation in fiscal year 1984	68
Trade monitoring	19	Appendix E. Statutes involving the U.S. International Trade Commission	73
Summaries of trade and tariff information	19		
Office of Economics	20		
Investigation Support Division	20		
Economic Research Division	21		
Trade monitoring and reporting	22		

Summary of Activities

Investigations Completed

Tariff Act of 1930:	
Sec. 332 investigations	20
Sec. 337 investigations of alleged unfair practices in the importation and sale of imported products	37
Antidumping and countervailing duty investigations (countervailing duty, 25, consisting of 19 preliminary and 6 final; antidumping investigations, 92, consisting of 59 preliminary, 32 final, and 1 review)	117
Trade Act of 1974:	
Sec. 131 and sec. 503 advice on possible trade agreements	1
Sec. 201 "escape-clause" cases	5
Sec. 406 "market disruption" investigation	1
Trade Agreements Act of 1979, sec. 104, review of countervailing duty cases	4
Agricultural Adjustment Act, sec. 22 investigation	1
Total	186

Other Activities

Reports prepared on proposed legislation	137
Reports prepared on specified commodities	11
Reports prepared on East-West trade	4
Trade-monitoring reports	5
Summaries of trade and tariff information	59
Responses to requests from Members of Congress and congressional committees	1,922
Publications issued (in addition to reports on investigations):	
Synthetic organic chemicals, production and sales	13
Benzenoid chemicals, imports	1
Library transactions:	
Reference calls	15,922

Introduction to the USITC

The United States International Trade Commission is an independent, bipartisan, quasi-judicial agency with broad powers to investigate all factors relating to the effect of U.S. foreign trade on domestic production, employment, and consumption. Although not charged with a policymaking role, the Commission contributes substantially to the development of sound, equitable international trade policy.

Commission activities include—

- Making recommendations to the President regarding relief for industries seriously injured by increasing imports;
- Determining whether U.S. industries are materially injured by imports that benefit from pricing below fair value or subsidization;
- Directing action, subject to Presidential disapproval, against unfair trade practices such as patent infringement;
- Advising the President whether agricultural imports interfere with price-support programs of the U.S. Department of Agriculture;
- Conducting studies on trade and tariff issues and monitoring import levels; and
- Participating in the development of uniform statistical data on imports, exports, and domestic production, and the establishment of an international harmonized commodity code.

By statute, the Commission may act on its own initiative, on the petition of interested parties, or at the request of the President, the United States Trade Representative, the House Ways and Means Committee, or the Senate Finance Committee. The Commission staff of more than 436 men and women, including attorneys, economists, investigators, commodity-industry analysts, and data system programmers, gathers information and evaluates data to assist the Commission in its determinations. To get the facts and ensure that all sides of an issue are heard, extensive fieldwork is undertaken, and public hearings are held in Washington, DC, or, occasionally, in other parts of the country. The views of interested and affected parties such as labor, industry, agriculture, importers, and consumers are represented and evaluated in the Commission's work.



1



2



3

The Commission instituted the section 201 investigation on nonrubber footwear on February 3, 1984, after receipt of a petition for import relief filed by the Footwear Industries of America, the Amalgamated Clothing & Textile Workers Union, AFL-CIO, and the United Food & Commercial Workers International Union, AFL-CIO. On June 6, 1984, the Commission unanimously determined that imports of nonrubber footwear were not being imported into the United States in such increased quantities as to be a substantial cause of serious injury to the domestic industry. Witnesses testifying at a public hearing at the Commission on May 2, 1984, included (1) Senator John Danforth, Republican of Missouri, and (2) Lane Kirkland, president of the AFL-CIO. (3) From left: Senator William S. Cohen, Republican of Maine, Congressman William Alexander, Democrat of Arkansas, and Senator George Mitchell, Democrat of Maine, hold a press conference at the ITC Building before testifying in support of the nonrubber footwear petition.

Part I. Investigative Highlights

Investigations Under Sections 201 and 203(i) of the Trade Act of 1974, the "Escape Clause"

Section 201 of the Trade Act of 1974 (19 U.S.C. 2251) provides a procedure whereby domestic industries seriously injured by increased imports can petition for import relief in the form of tariffs or quantitative restrictions (import quotas).¹ To be found eligible for relief under section 201, industries need not prove that an unfair trade practice exists, as is necessary under the antidumping and countervailing duty laws and section 337 of the Tariff Act of 1930. However, under section 201, a greater degree of injury, "serious" injury, must be found to exist. In addition, relief under section 201, although temporary, should be tailored to the needs of the injured industry.

The criteria for import relief set forth in section 201 of the Trade Act of 1974 are based on article XIX of the General Agreement on Tariffs and Trade (GATT), an international agreement to which the United States is a signatory. Article XIX of the GATT is referred to as the escape clause because it permits a country to "escape" temporarily from its obligations under the GATT with respect to a product when increased imports of that product are causing or threatening to cause serious injury to domestic producers of a like or directly competitive product. Commission investigations under section 201 provide a basis for the President to invoke article XIX.

During fiscal year 1984, the Commission completed five section 201 investigations, more than twice the number completed in fiscal years 1982 and 1983. Of the five investigations, the Commission made three negative determinations and two affirmative determinations. The investigations covered a diverse group of products: stainless steel table flatware, nonrubber footwear, carbon and alloy steel, unwrought copper, and canned tuna

fish. The petitions, all of which were filed within a 3-month period, placed unusual demands on the Commission, which also experienced a substantial increase in other statutory investigations. During the period of the investigations, the Commission spent a total of 14 days, including 10 evenings, hearing testimony from 485 witnesses and attorneys representing 153 parties.

The Commission instituted the first investigation, *Stainless Steel Table Flatware* (TA-201-49), on December 13, 1983, after receiving a petition for import relief filed by the Stainless Steel Flatware Manufacturers Association. On May 1, 1984, the Commission unanimously determined that the stainless steel table flatware products were not being imported into the United States in such increased quantities as to be a substantial cause of serious injury, or

¹ The law requires the Commission to conduct such investigations upon receipt of a petition from an entity representative of a domestic industry, at the request of the President or the United States Trade Representative, or upon resolution of the House Committee on Ways and Means or the Senate Committee on Finance. The Commission also may conduct such investigations on its own motion. If, as a result of an investigation, the Commission finds that an article is being imported into the United States in such increased quantities as to be a substantial cause of serious injury, or threat thereof, to the domestic industry, it must recommend to the President the tariff or quota relief necessary to prevent or remedy the injury or recommend the provision of adjustment assistance. The Commission must complete its investigation and make its determination and any recommendations within 6 months of receipt of the petition, request, or resolution. If the Commission finds in the affirmative and recommends tariff or quota relief, the President has an additional 60 days in which to advise Congress of what, if any, relief he will provide. If the President decides to take action different from that recommended by the Commission or decides to take no action, Congress may, by enacting a joint resolution within 90 legislative days, direct the President to provide the relief recommended by the Commission. If the Commission's determination is negative, the sec. 201 proceeding is terminated.



1

On January 26, 1984, the Commission instituted an investigation under section 201 of the Trade Act of 1974 at the request of 10 domestic copper producers.

At a public hearing on May 15, 1984, the Commission heard testimony from congressional and State representatives, public officials, and officials representing both the domestic industry and foreign importers. Witnesses included (1) Senator Pete V. Domenici, Republican from New Mexico (right), and Senator Dennis Deconcini, Democrat from Arizona (in background), and (2) Congressman Robert Davis, Republican from Michigan.



2

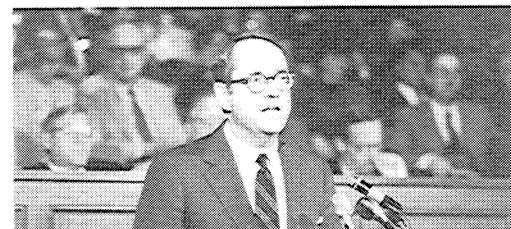
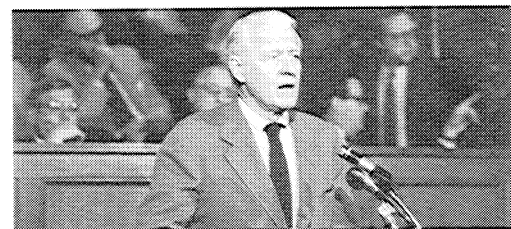
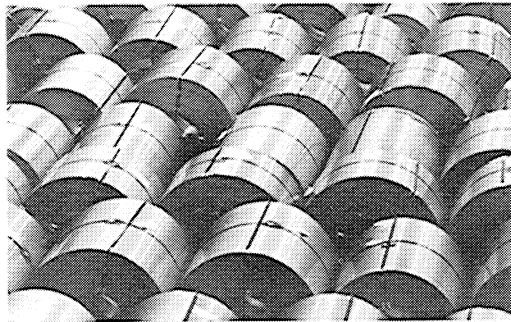

On January 24, 1984, the U.S. International Trade Commission instituted an investigation on carbon and alloy steel products after receiving a petition for import relief filed on behalf of the United Steel Workers of America, AFL-CIO, and (1) Bethlehem Steel Corp.

During 3 days of hearings, 1 of which was held at the Department of Commerce auditorium, the Commission heard testimony from congressional and State representatives and witnesses for and against the petition. On June 12, 1984, the Commission determined by a vote of 3 to 2 that imports of carbon steel products were being imported into the United States in such increased quantities as to be a substantial cause of serious injury to the domestic industry. Witnesses included (2) Senator John Heinz, Republican from Pennsylvania, (3) Senator Arlen Specter, Republican from Pennsylvania, (4) Governor Robert Orr, of Indiana, (5) Governor Richard Thornburgh, of Pennsylvania, and (6) Edward Rutkowski, County Executive, Erie County, New York.

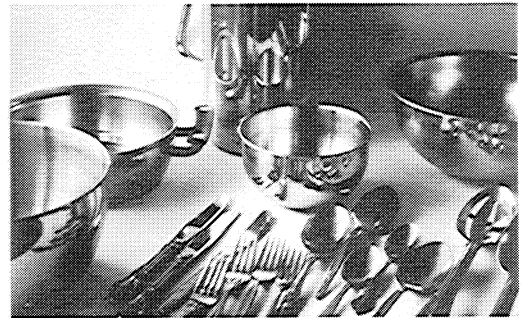

(7) Stainless steel table flatware shown was the subject of an investigation conducted by the Commission under section 201 of the Trade Act of 1974 to determine whether the products were being imported into the United States in such increased quantities as to be a substantial cause of serious injury to the domestic stainless steel table flatware industry. The Commission instituted the investigation on December 13, 1983, at the request of the Stainless Steel Flatware Manufacturers Association.



2
On February 15, 1984, the Commission instituted the investigation on tuna fish under section 201 of the Trade Act of 1974 at the request of six domestic tuna fish producers. At a public hearing held on June 5, 1984, at the Commission Hearing Room, the Commission heard testimony from congressional and State representatives, public officials, and officials representing both the domestic industry and the foreign importers. Witnesses included (1) Senator Pete Wilson, Republican of California, and (2) Congressman John Breaux, Democrat of Louisiana. On July 25, 1984, the Commission determined that imports of canned tuna fish were not being imported into the United States in such increased quantities as to be a substantial cause of serious injury to the domestic tuna fish industry.



3
The Commission instituted an investigation on fresh cut roses from Colombia under section 731 of the Tariff Act of 1930 in response to a petition for import relief filed on September 30, 1983, by Roses, Inc., a U.S. commercial rose growers' trade association. On August 28, 1984, the Commission determined that imports of fresh cut roses from Colombia were not causing material injury to a U.S. industry. (3) Cut roses are displayed at a public hearing at the Commission on June 28, 1984.

threat thereof, to the domestic industry. Because of the Commission's negative determination, no recommendation was made to the President for import relief.

Nonrubber Footwear (TA-201-50) is the third footwear investigation the Commission has conducted under section 201 of the Trade Act of 1974 and the first in which the Commission has made a negative determination. The investigation was instituted on February 3, 1984, in response to a petition for import relief filed by the Footwear Industries of America, the Amalgamated Clothing & Textile Workers Union, AFL-CIO, and the United Food & Commercial Workers International Union, AFL-CIO. The Commission concluded that increased imports were not a substantial cause of serious injury, or threat thereof, to the domestic industry.

The third investigation, *Certain Carbon and Alloy Steel Products* (TA-201-51), generated more publicity than any of the other four section 201 investigations. The Commission instituted the carbon and alloy steel investigation on January 24, 1984, after receiving a petition for import relief filed by the United Steelworkers of America, AFL-CIO, and Bethlehem Steel Corp.

After 3 days of testimony from congressional and State representatives and from witnesses for and against the petition, the Commission determined, by a vote of 3 to 2, on June 12, 1984, that certain carbon and alloy steel products were being imported into the United States in such increased quantities as to be a substantial cause of serious injury, or threat thereof, to the domestic industry. The Commission made a negative determination with respect to certain other carbon and alloy steel products, including bar, rod, pipe and tube, and railway products.

As a result of the affirmative determinations, the Commission found that it was necessary for the President to impose, with certain exclusions, a combination of tariffs and quotas on the imports. On July 24, 1984, the Commission transmitted its report recommending relief to the President.

In a statement issued by the United States Trade Representative on September 18, 1984, the President announced, after taking into account the national interest, that he would not impose the increased tariffs and import quotas recommended by the Commission but rather would seek to negotiate import restraint agreements with certain foreign countries.

In *Unwrought Copper* (TA-201-52), the Commission concluded that increased imports were seriously injuring the domestic copper industry. The Commission made its determination after receipt of a petition filed by 10 domestic copper producers on January 26, 1984.

As a result of the affirmative determinations, Chairwoman Paula Stern and Commissioner David B. Rohr recommended to the President that he increase the tariffs on imported copper, and Commissioners Alfred E. Eckes and Seeley G. Lodwick recommended that he impose quotas on the imports. On September 6, 1984, the President announced that he would not impose the relief recommended by either group of Commissioners, because he concluded that relief was not in the overall national economic interest. Further, the President determined that import restrictions would complicate efforts to maintain the stability of the international financial system and would reduce the ability of foreign countries to import goods from the United States.

In the final investigation, *Certain Canned Tuna Fish* (TA-201-53), the Commission determined that tuna fish products were not being imported in such increased quantities as to be a substantial cause of serious injury to the domestic industry. Because of the Commission's negative determination, no recommendation was made to the President as to import relief for the domestic tuna fish industry.

The Commission conducted no "re-view" investigations under section 203 of the Trade Act during fiscal year 1984.

“Market Disruption” Investigations

Under section 406 of the Trade Act of 1974 (19 U.S.C. 2436), the Commission conducts investigations to determine whether imports from a Communist country are disrupting a U.S. market. Section 406 is in many respects an adjunct provision to section 201 and adopts by reference petition, relief, and override procedures of section 201 as well as its definitions of industry and its hearing requirement. However, section 406 investigations must be completed in 3 months. Market disruption exists within a domestic industry whenever imports from a Communist country are increasing rapidly, either absolutely or relatively, so as to be a significant cause of material injury, or threat thereof, to the domestic industry. If the Commission determines that market disruption exists, it may recommend import relief in the form of tariffs or quantitative restrictions (import quotas). The President may impose quotas or duties or negotiate orderly marketing agreements to remedy market disruption.

The Commission completed one investigation under section 406 during fiscal year 1984. In the investigation, *Ferrosilicon From the Union of Soviet Socialist Republics* (TA-406-10), the Commission found that market disruption did not exist.

Investigations Under Title VII of the Tariff Act of 1930

Under title VII of the Tariff Act of 1930 (19 U.S.C. 1671, as added by the Trade Agreements Act of 1979), the Commission conducts preliminary and final investigations to determine whether there is a reasonable indication that (in preliminary investigations) or whether (in final investigations) a U.S. industry is materially injured or threatened with material injury, or

the establishment of such an industry is materially retarded, by reason of imports of merchandise that is being sold at less than fair value (i.e., dumped) or is benefiting from foreign subsidies. The Department of Commerce determines whether dumping or subsidies exist and, if so, the margin of dumping or amount of the subsidy.

Antidumping Investigations

During fiscal year 1984, the Commission completed 59 preliminary and 32 final antidumping investigations under section 731 and 1 review investigation under section 751 of the Tariff Act of 1930 (19 U.S.C. 1671). Of the 92 investigations completed during the fiscal year, 36 involved steel products such as carbon steel wire rod, stainless steel sheet and strip, welded carbon steel pipes and tubes, steel valves and parts, and carbon steel plate and sheet. Other investigations dealt with a diverse group of products including fresh cut roses, color television receivers, egg filler flats, potassium chloride, titanium sponge, and portland cement. With respect to food products, the Commission investigated such items as lamb meat, red raspberries, fresh potatoes, and dried, salted codfish.

At the close of the fiscal year, the Commission had 2 preliminary and 20 final antidumping investigations pending. These investigations also involve a wide range of products.

Countervailing Duty Investigations

The Commission conducts investigations under the countervailing duty laws only when the imports are from a country that is a signatory to the Code on Subsidies and Countervailing Duties or has undertaken similar obligations, or when the subject imports enter duty free. Most of the major free-world trading nations have signed the Code; some, such as Mex-

ico, have not. With respect to imports from countries that have not signed the Code or undertaken similar obligations, an injury test is available only for products that enter the United States free of duty under section 303(a)(2) of the Tariff Act of 1930 (19 U.S.C. 1303).

During the fiscal year, the Commission completed 19 preliminary and 6 final countervailing duty investigations. Of the 25 investigations completed, 9 involved steel products. The remaining 16 investigations covered a variety of products, including pads for woodwind instrument keys, table wine, cotton shop towels, and carbon steel wire rod.

At the close of the fiscal year, the Commission had four final and two preliminary countervailing duty investigations pending.



At the request of the United States Trade Representative, the Commission instituted an investigation under section 406 of the Trade Act of 1974 to determine whether imports of ferrosilicon from the Soviet Union are disrupting a U.S. market. A public hearing was held on January 6, 1984, in the Commission Hearing Room. Witnesses included (1) Congressman Doug Walgren, Democrat of Pennsylvania.

Section 751 Review Investigations

Section 751 of the Tariff Act of 1930 (19 U.S.C. 1675) sets forth a procedure for the review of outstanding antidumping and countervailing duty determinations. Under section 751, whenever the Commission receives information concerning, or a request for a review of, an outstanding countervailing duty or antidumping duty determination, it must first determine whether there are changed circumstances sufficient to warrant such a review. If there are, the Commission conducts review investigations. In the absence of good cause, the Commission may not conduct a review less than 24 months after publication of notice of the original determination.

During fiscal year 1984, the Commission instituted one review investigation under section 751, *Acrylic Sheet From Japan* (751-TA-8). At the close of the fiscal year, the Commission had two investigations pending under section 751, *Dry Cleaning Machinery From the Federal Republic of Germany* (751-TA-9) and *Frozen Concentrated Orange Juice From Brazil* (751-TA-10).

Section 104(b) Countervailing Duty Review Investigations

During fiscal year 1984, the Commission completed four investigations under section 104(b) of the Trade Agreements Act of 1979 (19 U.S.C. 1671 note). Section 104(b) requires the Commission, at the request of a foreign government that has signed the Subsidies Code or exporters from that country, to review outstanding orders issued under section 303 of the Tariff Act of 1930 (19 U.S.C. 1303) to determine whether a U.S. industry would be materially injured or threatened with material injury, or whether the establishment of

Statutory Timetable for Antidumping Investigations (in days)

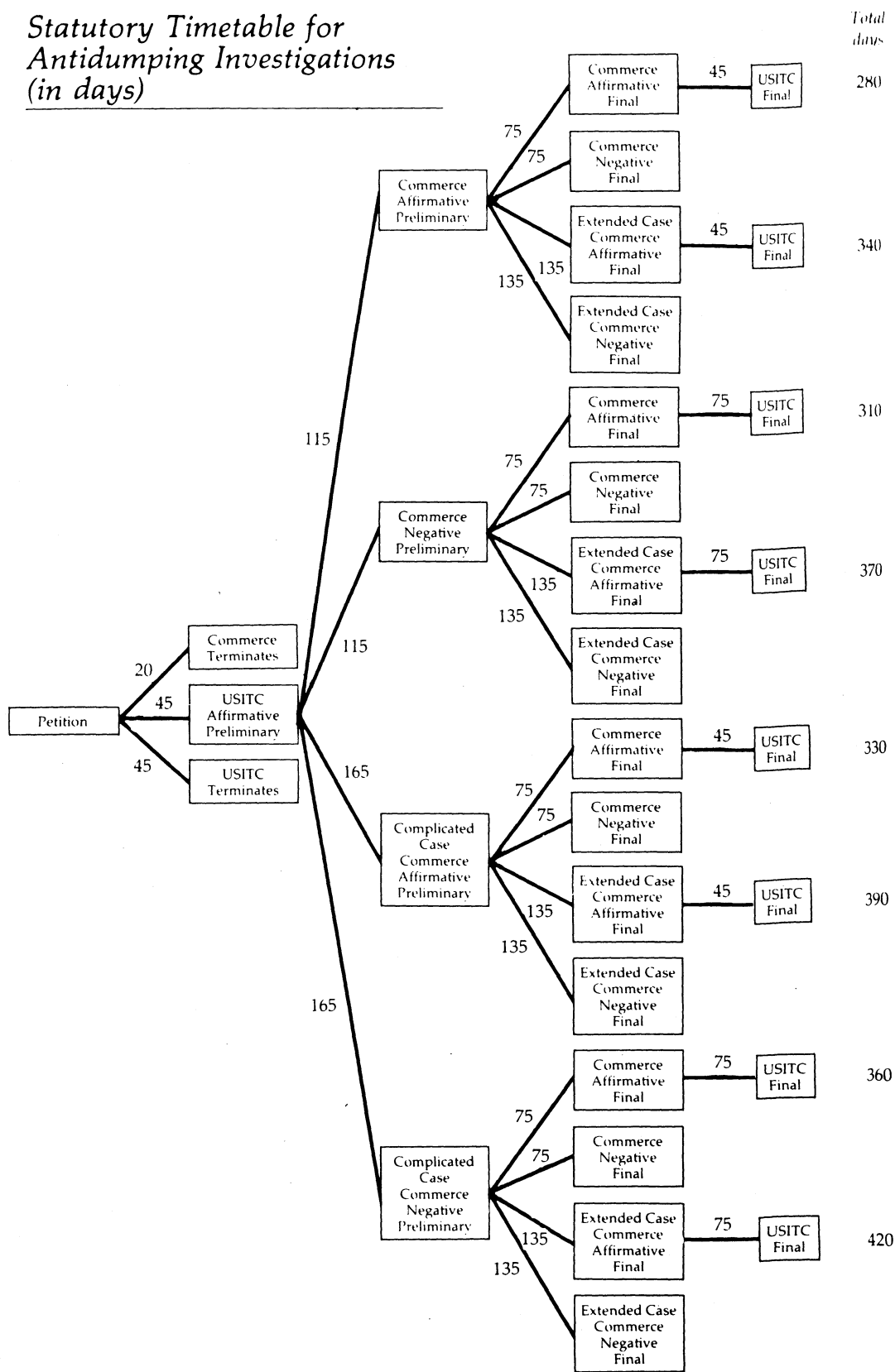

*Statutory Timetable for
Countervailing Duty
Investigations (in days)*

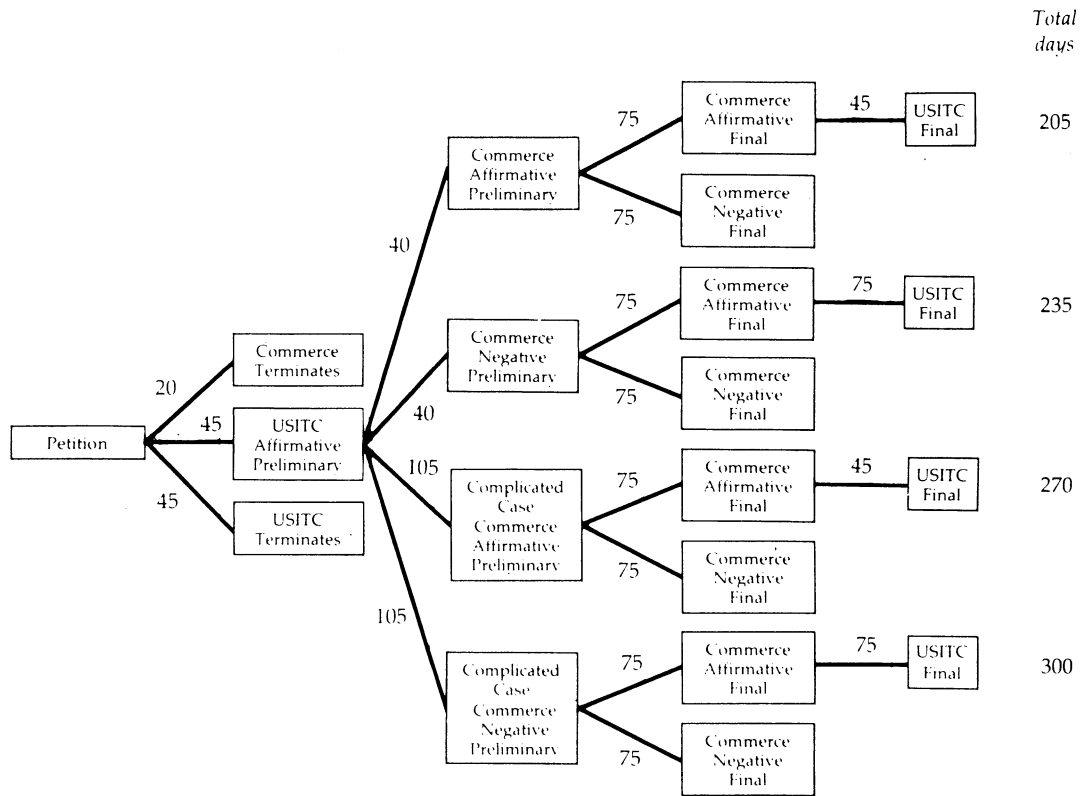

an industry would be materially retarded, if an existing countervailing duty order were to be revoked. Petitions requesting a review under section 104(b) must have been filed within 3 years of the effective date of title VII. Most of the countervailing duty orders in effect at the time the Trade Agreements Act went into effect had been issued without a Commission injury finding.

In two investigations completed under section 104, *Certain Scissors and Shears From Brazil* (104-TAA-19) and *Bottled Green Olives From Spain* (104-TAA-22), the Commission determined that a U.S. industry would not be materially injured if the existing countervailing duty order were to be revoked.

In a third investigation, *Cotton Yarn From Brazil* (104-TAA-21), the Commission partially determined that a U.S. industry would be materially injured if the existing countervailing duty order were to be revoked against imports of 100 percent cotton carded yarn. With respect to all other cotton yarn, however, the Commission determined that the countervailing duty could be revoked without injuring a U.S. industry. Petitions requesting review were withdrawn, and the Commission investigation was terminated.

Section 22 Investigations

During fiscal year 1984, the Commission completed one investigation under section 22 of the Agricultural Adjustment Act (7 U.S.C. 624). Section 22 calls for the Secretary of Agriculture to alert the President when he believes agricultural commodities are being, or are practically certain to be, imported into the United States in such quantities as to render or tend to render ineffective, or materially interfere with, U.S. Department of Agriculture (USDA) programs, including price-support programs, or substantially reduce the amount of any product processed from a commodity covered by a USDA program.

If the President agrees with the Secretary of Agriculture, he directs the Commission to conduct an investigation and develop a report, including findings and recommendations, for his consideration. After receiving the Commission's report, the President may impose quotas or duties (not to exceed 50 percent of the imported product's value) to protect the program. In cases in which the Secretary of Agriculture determines that an emergency exists, the President may take action before the Commission completes the investigation and submits the report. Any such emergency action that is taken would continue in effect pending the Commission's eventual report and recommendation.

The Commission instituted an investigation, *Certain Articles Containing Sugar* (22-46), on July 7, 1983, at the request of the President, to determine whether certain articles containing sugars derived from sugar cane or sugar beets are being, or are practically certain to be, imported under such conditions, at such prices, and in such quantities as to render or tend to render ineffective, or materially interfere with, the USDA price-support program for sugar cane and sugar beets.

The President's letter, dated June 28, 1983, also stated that he was that day taking emergency action under section 22(b) of the Agricultural Adjustment Act and issuing a proclamation establishing quotas of zero pounds for certain sugar articles. Such quotas were to continue in effect pending the report and recommendation of the Commission and possible subsequent Presidential action.

After a 5-month investigation, the Commission determined on December 7, 1983, that imports of the blended syrups, flavored syrups, flavored sugars, and certain edible preparations that were included in the emergency quotas established by the

President's proclamation were practically certain to be imported into the United States under such conditions and in such quantities as to materially interfere with the price-support program for sugar cane and sugar beets undertaken by the Department of Agriculture.

In view of its affirmative determination, the Commission, on December 16, 1983, recommended to the President that he continue to impose quotas on the articles.

At the end of the fiscal year, there was one investigation pending under section 22.

Unfair Import Practice Investigations

The Commission, under section 337 of the Tariff Act of 1930 (19 U.S.C. 1337), applies U.S. statutory and common law of unfair competition to the importation of articles into the United States and in their sale. Most violations of section 337 require finding both an unfair act in the importation into or sale in the United States of an article and a resulting actual, or tendency toward, substantial injury. If the Commission finds a violation of section 337, it can issue orders excluding the offending articles from entry into the United States as well as cease and desist orders, unless it determines that such orders should not be issued in view of public-interest considerations. Commission orders go into effect 60 days after issuance unless disapproved by the President. Appeals of Commission orders are heard by the Court of Appeals for the Federal Circuit. Violations of Commission section 337 orders are liable for civil penalties of up to \$10,000 a day.

Section 337 investigations involve formal evidentiary hearings held in accordance with the Administrative Procedure Act (5 U.S.C. 551 et seq.) before an administrative law judge (ALJ). Parties to these investigations include complainants, respondents, and the Commission staff representing the public. The investigations generally involve allegations of infringement

of patent, copyright, or trademark; trade secret theft; passing off; or violation of the antitrust laws. They must be completed within 12 months, or within 18 months in more complicated cases. Complainants may seek temporary relief pending final resolution of a case.

The Commission continues to hear patent-based investigations involving significant "high-tech" industries. Section 337 investigations on new and developing products during fiscal year 1984 included *Cardiac Pacemakers* (337-TA-162), *Amorphous Metal Articles* (337-TA-143), *Automated Fingerprint Identification Systems* (337-TA-156), *Optical Waveguide Fibers* (337-TA-189), and *Aramid Fibers* (337-TA-194). These products are enjoying wide market acceptance or promise, and the investigations are often actively and aggressively litigated.

The Commission is also hearing investigations that present other novel unfair competition issues. For example, the Commission decided in *Duracell Alkaline Batteries* (337-TA-165) that the importation and sale of authentic foreign-licensed and foreign-made Duracell batteries unlicensed in the United States is an unfair method of competition in violation of section 337 that causes substantial injury to the domestically made Duracell batteries. Another investigation, *Products with Gremlin Character Depictions* (337-TA-201), alleges that importation of articles containing copyrighted Gremlin character depictions without license violates section 337. Temporary relief is being sought in this investigation.

The Commission has also undertaken a preliminary investigation of possible unfair import practices under section 603 (19 U.S.C. 2482), *Hydrogenerators From Japan* (603-TA-9).

In all, the Commission initiated 39 investigations and completed 35 investigations during fiscal year 1984. Both were increases over the number in previous years. At the end of fiscal year 1984, there were 40 investigations under section 337 pending.

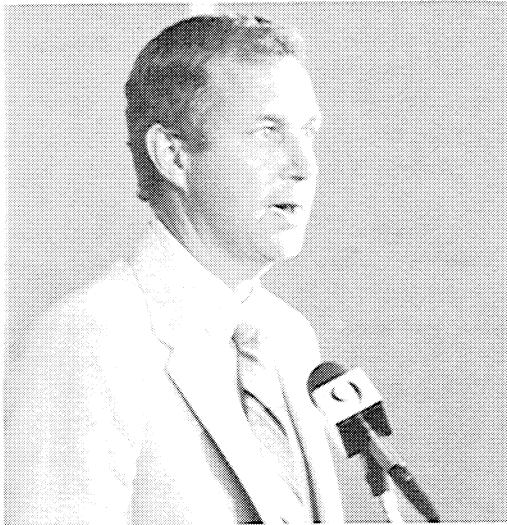

1



2

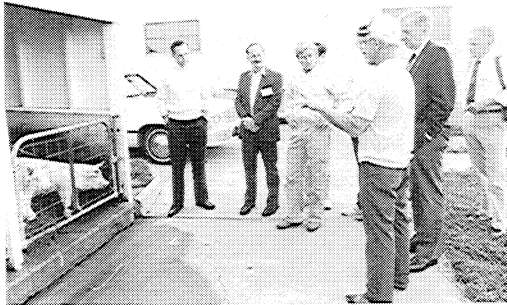

3

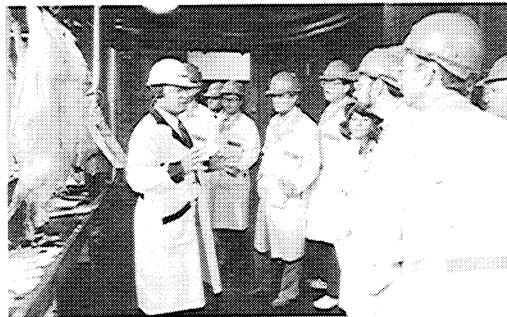

4



5

The Commission instituted an investigation under section 332 of the Tariff Act of 1930 at the request of the U.S. Senate Committee on Finance on June 25, 1984, to gather information on the competitive and economic factors affecting the U.S. and Canadian live swine and pork industries in U.S. markets. On September 21, 1984, a public hearing was held in Cedar Rapids, Iowa, where the Commissioners heard testimony from congressional and State representatives and public officials representing the domestic industry and foreign importers. Witnesses included (1) Don Gingerich, an Iowa hog farmer, and (2) Donna Keppy, an Iowa pork producer. ITC Commissioners and staff members also visited a hog farm and production plant while in Iowa. (3) Paul Kepler (white cap), manager of Farmland Station in Lisbon, explains operations at the hog farm to ITC Commissioners and staff members and (4,5) a manager at the Farmstead Foods Plant in Cedar Rapids explains how hogs are processed and packaged for delivery.

Part II. Organizational Activities

Office of Investigations

The Office of Investigations has the responsibility for conducting most of the Commission's investigations with statutory deadlines. The principal operating units in the Office of Investigations are the Unfair Import Investigations Division (UIID) and three nonadjudicative investigation divisions. UIID, with its staff of investigative attorneys, conducts adjudicative investigations relating to unfair import practices under section 337 of the Tariff Act of 1930. The three nonadjudicative divisions conduct countervailing duty and antidumping investigations under provisions of the Tariff Act of 1930, escape-clause and market disruption investigations pursuant to the Trade Act of 1974, and investigations under the Agricultural Adjustment Act to determine whether imports of agricultural products are interfering with programs of the U.S. Department of Agriculture.

The trend toward an ever-increasing statutory investigations workload continued unabated in 1984. However, there were some significant shifts in the composition of the investigations instituted in 1984: more investigations of unfair import practices under section 337 of the Tariff Act of 1930 and more antidumping investigations and fewer countervailing duty investigations. Another shift in the composition of the investigations instituted occurred with section 337 cases, where the share of the workload represented by intellectual property rights cases increased and the share of patent violation cases declined. There was also a surge in import relief investigations under section 201 of the Trade Act of 1974 in fiscal year 1984. Section 201 investigations were conducted on stainless steel flatware, nonrubber footwear, unwrought copper, canned tuna fish, and certain carbon and alloy steel products.

Although virtually all sectors of the U.S. industrial base were affected by Commission investigations in fiscal year 1984,

the sector that was the most affected was the one producing carbon steel products. These products were the subject of numerous dumping and countervailing duty investigations and the subject of a major import relief investigation. There was also a significant increase in the filing of dumping and countervailing duty petitions against imported agricultural products in 1984.

In order to cope with the increased workload in the Office of Investigations, the Commission approved the creation of a fourth nonadjudicative division within the office and the establishment of a separate division of accounting and financial analysis. Staffing of the accounting and financial analysis unit is nearly complete, and staffing of the additional nonadjudicative division is underway.

Office of Industries

The Office of Industries is responsible for providing the Commission and the public with detailed technical and economic information on U.S. industries and merchandise trade. The Commission requires such information to meet its investigative and other technical responsibilities, including such areas as tariff nomenclature, trade monitoring, and review of proposed trade legislation. In order to develop and maintain the required commodity-industry expertise for ready access by the Commission, the Office is organized into six commodity Divisions covering the major industrial sectors—agriculture and forest products, textiles and apparel, energy and chemicals, minerals and metals, machinery and equipment, and miscellaneous manufactures. Within these divisions there are some 75 international trade analysts who keep track of the import, export, production, and sale of more than 12,000 items of world trade. These specialists' expertise has been in growing demand as U.S. businesses have increased their activities in international trade. The President, Congress, and the Commission often rely heavily upon



1



2

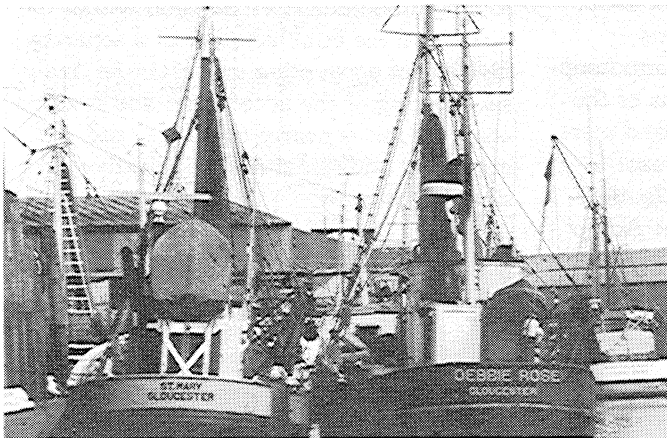

3



4

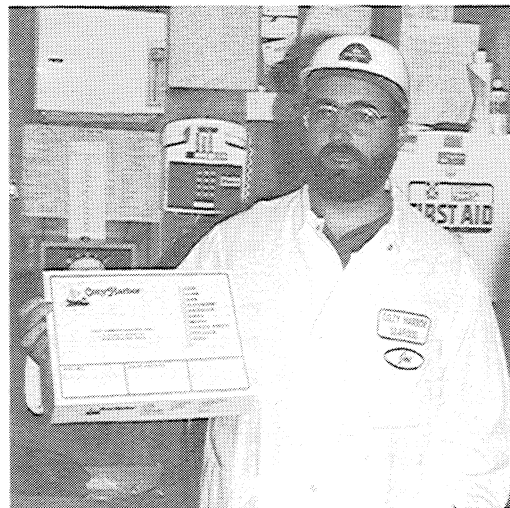

5

Public hearings in Boston (1,2) on September 5, and Portland, Maine, on September 7, 1984, were convened by the Commission to obtain testimony during a factfinding investigation under section 332 of the Tariff Act of 1930 on the conditions of competition affecting the northeastern U.S. groundfish and scallop industries in the United States. Field visits for firsthand information to fishing ports, including Gloucester (3), and Portland's Cozy Harbor Seafood, a processing plant (4,5), were made by Commissioners and the investigative staff. The investigation was requested by the United States Trade Representative.

the expertise of the analysts to obtain an objective picture of the impact of international trade (imports and exports) on U.S. industry and the factors influencing the competitive position of U.S. industry in world trade.

Investigations Under Section 332

During fiscal year 1984, the Office of Industries conducted 40 investigations under section 332¹ of the Tariff Act of 1930, including both one-time, factfinding studies and continuing industry surveys. A number of these studies explored areas where there is relatively little available information or investigative precedent. Such efforts included Commission studies on the effects of foreign product counterfeiting on U.S. industry, the implications of foreign-trade zones for U.S. industries, and the international competitiveness of U.S. producers in such areas as robotics, telecommunications equipment, foundry products, ceramic tile, video games, handtools, industrial molds, and groundfish (app. B).

Nine continuing industry surveys were conducted under section 332 to aid the Congress or the executive branch in monitoring both U.S. imports and domestic production of various products. Four of these surveys were conducted at the request of the President, four were conducted at the request of Congress, and one continuing survey is being conducted as a result of the Commission's own motion. During fiscal year 1984, Industries published surveys covering synthetic organic chemicals (a Commission series extending continuously from 1916), canned mushrooms, brooms, stainless steel and alloy tool steel, steel subject to the United States-EC Arrangement, heavyweight motorcycles, and automobiles. During fiscal year

1984, new monitoring efforts were begun in the areas of rum and nonrubber footwear.

At the beginning of fiscal year 1984, the Commission had 13 factfinding studies underway. During the year, an additional 22 studies were initiated, and 18 were completed. At the end of the fiscal year, the Commission had 17 section 332 studies underway. Certain of the completed studies are highlighted below.

Competitive Position of U.S. Producers of Robotics in Domestic and World Markets (332-155)

This study was undertaken to assess the competitive position of U.S. producers of robotics in domestic and foreign markets. The study addresses the impact of growing competition in the industry and explores related developments most likely to affect the future market position of the U.S. industry during 1979-83. Future competition in robotics is discussed.

The Effects of Foreign Product Counterfeiting on U.S. Industry (332-158)

The Commission, on its own motion, instituted this investigation into the foreign counterfeiting of U.S. products. The objectives of the investigation were (1) to identify those product sectors in which the U.S. industry faces competition from foreign counterfeited products, either in the United States or abroad, (2) to assess the impact such counterfeiting has had on these industries and U.S. exports, (3) to identify the primary country sources of counterfeiting, (4) to inventory the methods U.S. firms are using to counteract counterfeiting and their recommendations for Government action, and (5) to compile an inventory of U.S. and foreign laws and international agreements encompassing counterfeiting, including the avenues of relief available.

¹Investigations conducted under sec. 332 are requested by the President, the House Ways and Means Committee, the Senate Finance Committee, or either House of Congress or are initiated on the Commission's own motion.



The Commission instituted an investigation under section 332 of the Tariff Act of 1930 at the request of the Subcommittee on Trade, Committee on Ways and Means, U.S. House of Representatives, to examine the competitive

position of the U.S. wood and upholstered household furniture industry. A public hearing was held on April 3, 1984, in High Point, North Carolina. (1) A factory worker is shown assembling sections of a dresser.



At the request of the U.S. House Ways and Means Committee, the Commission instituted an investigation under section 332 of the Tariff Act of 1930 on June 1, 1983, to assess the trends in international trade in nonpowered handtools and the conditions of competition between domestic and foreign handtool producers. (2) Nonpowered handtools are displayed in the Commission Hearing Room during a public hearing on November 9, 1983.

*Possible Effects of Changing World
Crude Petroleum Prices (332-161)*

This study was conducted to assess the future supply and prices of crude petroleum and their possible effects on such areas as U.S. trade, the petroleum industry, the petrochemical industry, and other energy-intensive industries. Econometric models were used to forecast the possible effects of different world crude petroleum price scenarios on gross national product, net trade balance, and crude petroleum production for the United States, the Organization for Economic Cooperation and Development (OECD), the Organization of Petroleum Exporting Countries (OPEC), and non-OPEC developing countries.

*The Implications of Foreign-Trade
Zones for U.S. Industries and for
Competitive Conditions Between U.S.
and Foreign Firms (332-165)*

At the request of the Committee on Ways and Means of the U.S. House of Representatives, the Commission instituted an investigation into the implications of foreign-trade zones for U.S. industries and for competitive conditions between U.S. and foreign firms. The investigation reviews the effects on tariff revenue collection, employment, and the economy in general caused by the establishment of zones. Also, with respect to zones, the investigation addresses such issues as their current administration and operation; trends in usage; benefits; major manufacturing industries and the nature of their operations, with emphases on special-purpose zones; safeguards in the zone system; and industry concerns and recommendations for modification.

*Competitive Assessment of the U.S.
Wood and Upholstered Household
Furniture Industry (332-170)*

At the request of the Committee on Ways and Means of the U.S. House of Representatives, the Commission instituted

this study to examine the competitive position of the U.S. wood and upholstered household furniture industry, particularly with respect to imports from Taiwan, Canada, Denmark, Yugoslavia, and other Far Eastern countries. The study presents (1) a profile of the U.S. and major foreign furniture industries, (2) an analysis of the key economic factors in the U.S. market, including U.S. consumption, production, and trade, (3) a discussion of relevant U.S. and foreign Government policies and regulations and their influence on the wood and upholstered household furniture industry, and (4) an analysis of the conditions of competition in the U.S. market between domestic and foreign furniture products, including factors such as price, quality, marketing techniques, and the technology level.

*Changes in the U.S. Telecommunications
Industry and the Impact on
U.S. Telecommunications Trade
(332-172)*

At the request of the Committee on Finance, United States Senate, the Commission instituted this investigation to gather information for a report on the implications of recent court and regulatory changes and of the American Telephone & Telegraph Corp. (AT&T) divestiture on trade in telecommunications equipment. The study presents (1) a profile of the U.S. telecommunications industry with emphasis on its present and future competitive position in light of court and regulatory actions, especially the AT&T divestiture, (2) an analysis of key economic factors in the U.S. market for telecommunications equipment, (3) proposed trade nomenclature for imports and exports to provide an accurate U.S. trade information base for telecommunications equipment, and (4) the estimated impact of divestiture on the level and composition of trade in the near and long term.



1



2



3

At the request of the United States Trade Representative, the Commission instituted an investigation under section 332 of the Tariff Act of 1930 to obtain information concerning the probable economic effect on U.S. industries producing like or directly competitive articles and on consumers for changes in the list of articles eligible for GSP duty-free treatment. A public hearing was held in the Commission Hearing Room on September 27, 1983. Witnesses included (1) Gary L. Riley (left), president of the Cookware Group, General Housewares Corp., and Joseph W. Dorn, attorney representing General Housewares Corp.

(2) Arkansas Governor Bill Clinton testifies at a public hearing at the Commission on April 10, 1984. The Commission instituted an investigation under section 332 of the Tariff Act of 1930 at the request of the United States Trade Representative to determine the probable economic effects on U.S. industries of providing duty-free treatment for imports from Israel.

(3) Witnesses testify and display counterfeit products at a public hearing on foreign product counterfeiting on August 23, 1983. The Commission instituted the investigation under section 332 of the Tariff Act of 1930 to assess the impact of foreign product counterfeiting on U.S. industry, considering both the domestic and export markets.

International Developments in Biotechnology and Their Possible Impact on Certain Sectors of the U.S. Chemical Industry (332-174)

The competitiveness in world markets of chemical products produced by biotechnological processes, the current status of the world's biotechnology industry, possible future trends, and factors that could affect the biotechnology industry and trade are analyzed in this study. Factors affecting the biotechnology industry that were investigated include research and development, technology transfer, joint ventures, licensing, and Government participation. Pharmaceuticals, agrochemicals, and certain other organic chemicals are emphasized the most because of the importance of biotechnology-based products in each of these sectors.

Competitive Assessment of the U.S. Foundry Industry (332-176)

Following a request from the United States Trade Representative, at the direction of the President, the Commission instituted this investigation to examine conditions of competition between domestic and foreign castings producers. The report assesses structural characteristics of the U.S. industry and foreign industries (by major world suppliers), evaluating product attributes of U.S.- and foreign-made castings in the U.S. and foreign markets; examines the impact on domestic producers of competition from imports; and identifies steps that have been and may be taken in response to competition in the U.S. and foreign markets. The report includes an overview of the entire foundry industry, together with a detailed analysis of 10 selected key products that are representative of major segments of the foundry industry in terms of manufacturing process, import competition, shipments, marketing, and financial condition.

Trade Monitoring

During fiscal year 1984, the Office of Industries continued the quarterly report series entitled *U.S. Trade Shifts in Selected Commodity Areas*. The quarterly report is a byproduct of the Office's normal trade-monitoring activities and provides brief analyses of significant foreign-trade shifts in major industrial sectors as well as trade statistics for approximately 650 commodity groups within those major sectors. Four reports were issued in the series covering the second and third quarters of 1983, 1983 in its entirety, and the first quarter of 1984.

Summaries of Trade and Tariff Information

The Commission completed 59 new summaries of trade and tariff information and 48 updates of previously published summaries. The summaries provide the Congress, Government agencies, the public, and business institutions with information on the commodities listed in the Tariff Schedules of the United States.

This year, the completed summary series included 14 reports on animal and vegetable products, 10 on forest products, 8 on textiles and apparel, 6 on chemicals and related products, 1 on nonmetallic minerals and products, 15 on metals and metal products, and 5 on miscellaneous manufactured products. The current series, which is now complete, provides comprehensive coverage of product uses, manufacturing processes, and commercial practices and includes analyses of the numerous factors affecting U.S. and world trade in each commodity area. The completed summary series will be kept current through biannual supplements to each of the 244 individual reports in this series.

Office of Economics

The Office of Economics provides support in all areas of the Commission's work. The two principal responsibilities of the Commission—investigating the effects of imports on U.S. industries and providing expert advice to the Congress and the President on international trade issues—require analysis based on sound economic principles and methods.

The Office of Economics (OE) comprises three divisions. The largest, the Investigation Support Division, works closely with the Commission's Office of Investigations on statutory investigations, examining the economic effects of imports on U.S. producers of competitive goods. The Research Division works on studies of current issues in international trade requested by the Congress or the President or self-initiated by the Commission. The Trade Reports Division carries out trade-reporting functions for which the Commission has statutory responsibility. Trade Reports Division economists also continually monitor the economic, trade, and industrial policies of the nonmarket economies and of major U.S. trading partners.

Investigation Support Division

During fiscal year 1984, the Investigation Support Division (ISD) continued to provide comprehensive analysis of economic factors affecting the products subject to Commission investigations under the various import-injury statutes and in other types of Commission investigations.

In fiscal year 1984, the Commission completed five import-injury investigations under section 201 of the Trade Act of 1974. These investigations required a great deal of complex analysis on the part of ISD economists, since the Commission had to evaluate and rank all factors that caused injury to the petitioners, including the effects of economic cycles, of changing

consumption patterns, of U.S. producers' moving offshore to supply the U.S. market, and of the increased competitiveness of foreign producers.

For example, in two investigations—*Unwrought Copper* (TA-201-52) and *Carbon and Alloy Steel* (TA-201-51)—ISD economists provided extensive analyses on the role of consumer and capital spending in the U.S. markets for the products, the effects of exchange-rate fluctuations on U.S. trade in these products, and the implications of high interest rates on the industries and their customers. ISD economists also scrutinized the economic analyses presented by the parties to the investigations and helped the Commissioners evaluate these submissions. Extensive and thorough examination of the market behavior of the U.S. producers and their foreign competition was provided as background for the Commission's remedy recommendations for the copper and steel industries. ISD economists also advised the staff of the United States Trade Representative and other executive branch agencies regarding the Commission's findings and proposed remedies.

Steel and chemical products continued to dominate the Commission's agenda of investigations into allegations of unfairly traded imports during fiscal year 1984. Fifty-two of the 115 title VII investigations filed in fiscal year 1984 involved steel and chemical products. For many of these articles, the analysis of ISD economists played an important role in the final Commission determinations. For example, ISD economists provided important information on the role of transportation costs in determining the competitiveness of U.S. producers in both steel and chemicals. They also provided the extensive price data and indepth analysis of the market for cement on the west coast to help the Commission understand the industry's intricate market structure. The analysis of ISD economists

contributed in a similar manner to the investigation involving titanium sponge. This market was complicated by the role of U.S. Government purchases for strategic stockpiles.

ISD economists also participated in two investigations conducted under section 332 of the Trade Act of 1974. Both of these cases—*Industrial Molds from Canada* (332-169) and *Groundfish from Canada* (332-173)—involved complex price relationships and marketing practices where bidding and auction mechanisms required intensive analysis.

Economic Research Division

The Economic Research Division in the OE provides technical analyses of international economic issues of interest to the Commission and to policymakers in the Congress and in the administration. Most of the analyses are conducted under the Commission's section 332 program, which is jointly managed by the OE and the Office of Industries. Economic Research Division economists also regularly assist on import-injury investigations when the caseload of petitions is particularly heavy or when some aspect of an investigation requires an expertise that an economist in the Economic Research Division can provide.

As in fiscal year 1983, the most important research conducted by the OE in fiscal year 1984 was on the topic "Foreign Industrial Targeting and its Effects on U.S. Industries." This study was requested by the House Committee on Ways and Means in March 1983 and is being completed in three phases. The first phase covered targeting by Japan and included a definition of industrial targeting, a general discussion of the effects of targeting, and a review of the relevant literature. The report on the first phase was released to the Committee

on Ways and Means on October 7, 1983.¹ The second phase was released April 23, 1984,² and covered targeting by the European Community. The first two phases list a number of practices in Japan and in the European Community that constitute industrial targeting. The third phase was initiated on June 6, 1984, and covers targeting by Canada, Mexico, Brazil, Taiwan, and the Republic of Korea (Korea). This phase will be completed by January 1985. To gather data for the targeting study, Commission staff visited Government officials in Japan, France, West Germany, the United Kingdom, Brazil, Canada, Korea, Mexico, Taiwan, and the European Communities Commission in Belgium.

Two other studies were conducted by the Economic Research Division in fiscal year 1984. The first was *U.S. Trade Related Employment* (332-154), released to the public October 26, 1983. It estimates the job content of U.S. exports and imports for disaggregate industry sectors and individual U.S. trading partners. The second study was *China's Economic Development Strategies and Their Effects on U.S.-China Trade* (332-168). The study analyzes the effects of China's current 5-year plan and discusses recent changes in China's development strategies.

The Economic Research Division participated in one other study managed by the OE. This is a compilation of methodology to be used by the Commission staff in calculating the consumer cost of various import-relief measures. The study

¹*Foreign Industrial Targeting and Its Effects on U.S. Industries, Phase I: Japan: Report to the Subcommittee on Trade, Committee on Ways and Means, U.S. House of Representatives on Investigation No. 332-162 . . .*, USITC Publication 1437, October 1983.

²*Foreign Industrial Targeting and Its Effects on U.S. Industries, Phase II: The European Community and Member States: Report to the Subcommittee on Trade, Committee on Ways and Means, U.S. House of Representatives on Investigation No. 332-162 . . .*, USITC Publication 1517, April 1984.

was done in response to a request from the United States Trade Representative that the Commission supply estimates of the consumer costs of the import relief recommended by the Commission in affirmative section 201 investigations. The methodology developed in the study has already been used to estimate the consumer cost of section 201 relief for the steel and copper industries. These estimates were forwarded to the President for his review of these cases.

In addition to conducting studies managed by the Economic Research Division, economists made contributions to several studies managed by the Office of Industries. The most important of these was *Changes in the U.S. Telecommunications Industry and the Impact on U.S. Telecommunications Trade* (332-172).

As a result of the large number of petitions filed before the Commission in fiscal year 1984, the Economic Research Division was again asked to devote substantial resources to unfair practice and import-injury investigations. The Division provided economic analyses for a number of these investigations, including the section 201 investigations on copper; the anti-dumping cases on fresh potatoes from Canada, wire rod from Argentina, Spain, and Poland, staplers from Sweden, and mushrooms from the People's Republic of China; and the countervailing duty cases on wire rod from Spain, cotton yarn from Brazil, and olives from Spain.

Trade Monitoring and Reporting

The Trade Reports Division (TRD) continually monitors economic and policy developments abroad that are likely to have an important effect on U.S. commerce. Economists are assigned to cover the major U.S. trading partners (the European Community, Japan, Canada, Mexico, and the "newly industrialized" countries) and the main Communist economies (China, the Soviet Union, and Eastern Europe).

The foreign-country expertise of TRD complements the Commission's commodity trade expertise. At a time when the trade and industrial policies of foreign governments are of increasing concern, the expertise of this staff helps the Commission to serve the informational and analytical needs of the nation's trade policymakers in the Congress and the executive branch.

There is a growing demand for this foreign-country expertise in key areas of the Commission's work; the Commission's three studies of foreign industrial targeting practices described above were conducted principally by TRD economists. The country specialists visited each country studied and investigated targeting practices through interviews with the responsible government officials.

TRD economists handled some 200 informal foreign-trade inquiries, such as supplying figures on trade with the Pacific Rim countries and describing U.S. obligations under the General Agreement on Tariffs and Trade. The inquiries came from congressional offices, Government agencies, and the public. They also participated in the work of various subcommittees of the interagency Trade Policy Staff Committee (TPSC), which formulates the President's trade policy.

As an important part of its international trade-monitoring program, TRD produces three regular reports on trade and trade agreements activities for the Congress and the interested public. The Commission's annual report on the *Operation of the United States Trade Agreements Program* (OTAP)¹ is a reference source on U.S. trade policy activity. Some 2,000 copies of this report are distributed on request to U.S. and foreign government officials, academics, libraries, trade associations, and U.S. embassies around the world. The 35th report, covering trade agreements

¹The *Operation of the United States Trade Agreements Program* is prepared in conformity with sec. 163(b) of the Trade Act of 1974.

activities in calendar year 1983, was issued in June 1984. In addition to regular coverage of multilateral trade activities in the GATT and the Organization for Economic Cooperation and Development, U.S. bilateral trade relations with key countries, and the administration of U.S. trade law, the 35th OTAP also contained special reports on renewal of the Generalized System of Preferences (GSP) system, counterfeit trade, the new Caribbean Basin free-trade program, and the U.S. Bilateral Investment Treaty program. The report also began coverage of two increasingly important areas of U.S. trade policy—trade relations with the newly industrialized countries (Taiwan, Korea, and Brazil) and developments in international trade policy and regulation of the main services-producing sectors.

The Commission's quarterly reports on trade between the United States and the nonmarket economy countries (NME's)¹ reported in detail current trends in U.S.-NME developments and significant commercial and trade policy developments affecting this trade. The material on China's economy and U.S.-Chinese trade presented in the March 1984 report was used by a major network as background material for their reporting on the President's trip to China in April. A special section of the report issued in June 1984 presented estimates of U.S. exports of high-

¹Sec. 410 of the Trade Act of 1974 gives the Commission responsibility for the development and operation of an East-West Trade Statistics Monitoring System and requires reports on U.S.-Nonmarket Economy trade each calendar quarter.

During fiscal year 1984, the Commission produced the following reports: the *36th Quarterly Report to the Congress and the Trade Policy Committee on Trade Between the United States and the Nonmarket Economy Countries during July-September 1983*, USITC Publication 1468, December 1983; *37th Quarterly Report . . .* (1983 annual issue), USITC Publication 1511, March 1984; *38th Quarterly Report . . .*, USITC Publication 1547, June 1984; and *39th Quarterly Report . . .*, USITC Publication 1583, September 1984.

technology products and showed the reported destinations of these shipments over the past 5 years.

Fiscal year 1984 was the third year of operation of the Commission's East-West Trade Statistics Monitoring System, an automated system for monitoring all U.S. imports of manufactured goods from Communist countries and for analyzing them in relation to competing domestic production. As described in the Commission's 39th quarterly report on East-West trade,² the system identified nine products imported from NME's as candidates for closer analysis.

The monthly *International Economic Review* (IER), a staff publication of the Office of Economics, informs the Commission, the public, and others in the trade policy community on current trade-related statistics and policy developments in the areas monitored by Trade Reports Division economists.

Office of Tariff Affairs and Trade Agreements

The Commission makes several vital technical contributions to the U.S. Government's ability to monitor world trade, its efforts to reduce barriers to the international movement of goods and services, and its responsibility to represent the interests of U.S. industries. The 25 attorneys, nomenclature analysts, and other staff members who constitute the Office of Tariff Affairs and Trade Agreements assist the Commission in meeting its responsibilities in these areas.

A significant area of activity for the Office during fiscal year 1984 was its continuing work on the Harmonized Commodity Description and Coding System, an international classification system and statistical enumeration for merchandise in inter-

²*39th Quarterly Report . . .*, USITC Publication 1583, September 1984, pp. 37-57.

national trade. Development of the Harmonized System has been the joint work of many nations and international organizations under the auspices of the Customs Cooperation Council, headquartered in Brussels, Belgium. To facilitate trade, this new nomenclature would provide common descriptions for each article in international commerce.¹

During fiscal year 1984, staff members participated in meetings of the Harmonized System Committee and related bodies, pursuant to the Commission's continuing responsibility to express the needs of the U.S. business community as the Harmonized System was developed. At present, the Commission staff is involved in the revision of the Explanatory Notes to supplement the Harmonized System nomenclature, the draft conversion of the export schedule (Schedule B), and the SIC-based product codes on the basis of the Harmonized System, the maintenance of the tariff schedule converted to the Harmonized System, and the provision of technical assistance to other Government agencies in their work on the possible conversion to the new tariff system.

Should the President choose to seek such a conversion, the converted schedule would be presented to Congress in the form of draft legislation. This process would occur in the future. At present, the *Tariff Schedules of the United States Annotated* (TSUSA) continues to play an important part in ascertaining the U.S. position

in international commerce. Not only do the tariff schedules provide the duty rates applicable to all articles imported into the United States, but they also serve as the basis for the collection of statistics on U.S. imports. The latter function has become increasingly important in recent years as duty rates have been lowered and as international trade has grown in volume and complexity. The development of computerized data-processing technology has made sophisticated statistical data on trade flows available, delimited by the organization and content of the TSUSA, and this Office has played an important part in the formulation of that data.

The TSUSA contains approximately 7,000 legal classifications arranged in a hierarchical structure and describing every product in international trade. For the purpose of collecting duties, each classification is assigned a five-digit number that identifies the kind of product or products covered. For statistical purposes, many such legal provisions are subdivided into annotations, each of which adds two more digits to the identifying number, so that data may be gathered about imports of specified articles. There are now about 14,000 such annotations.

The Office chairs an interagency group known as the Committee for Statistical Annotation of Tariff Schedules. The Committee includes representatives of the Department of Commerce's Bureau of the Census and the Department of the Treasury's Customs Service. The Committee considers petitions from firms, business and industry groups, and Government agencies for establishing new statistical subcategories in the TSUSA and in the Statistical Classification of Domestic and Foreign Commodities Exported From the United States (Schedule B). During fiscal year 1984, the Committee considered 45 such requests. Twenty-five requests were adopted as proposed, 13 were adopted with some modifications, and 7 were rejected. The petitions that were adopted resulted in the creation of approximately 200 new items in the TSUSA and Schedule B.

¹In August 1981, President Reagan requested that the Commission initiate an investigation and draft a report to serve as the basis for the conversion of the Tariff Schedules of the United States (TSUS) into the format of the Harmonized System. The Commission conducted hearings and sought public comment in preparing its draft conversion, receiving numerous submissions from industries, associations, and Government agencies. The Commission submitted its report containing the converted tariff schedule and cross-references to the President on June 30, 1983. Following review by the Trade Policy Staff Committee, an updated version of the converted schedule was published in September 1984.

The Commission publishes new editions of the TSUSA annually and, during each year, supplements the current editions to reflect legislation, Presidential proclamations and Executive orders, and other modifications. During fiscal year 1984, the Commission published the 15th (1984) edition of the TSUSA, reflecting the fifth stage of tariff reductions negotiated during the Tokyo round of Multilateral Trade Negotiations under the GATT. Three supplements to the 1984 edition were issued during the fiscal year.

The Commission also issues the *History of the TSUSA*, containing all staged rates of duty, amendments and modifications in the legal text, and changes in statistical annotations to permit the tracing of individual products through various editions of the TSUSA. During fiscal year 1984, the Commission staff began preparation of a second supplement to the *History of the TSUSA*. In addition, the Office maintained the Looseleaf Consolidated U.S. Schedule of Concessions under the GATT, which is submitted to the other Contracting Parties and used by those involved in trade with the United States.

In another major area of activity during the fiscal year, the Office prepared 137 reports on pending trade and tariff legislation for the House Committee on Ways and Means and the Senate Committee on Finance and prepared or reviewed technical drafts for 6 Presidential proclamations and Executive orders for the Office of the United States Trade Representative. Staff members are also involved in the Commission's import-injury and section 332 investigations, such as the studies of foreign-trade zones, telecommunications equipment, nonrubber footwear, and titanium sponge.

Office personnel represent the U.S. Government on the Technical Committee on Trade in Civil Aircraft of the GATT and are involved in a technical capacity in other GATT-related activities, including preparations for negotiations under article XXVIII in connection with the future implementation of the Harmonized System.

In negotiations to begin in 1984, all signatory countries adopting the Harmonized System will review and renegotiate their schedules of concessions to bring them into conformity with the new nomenclature and to maintain, to the extent possible, the existing balance of concessions. The extensive modification of nomenclatures currently used is expected to result in incidental duty changes on hundreds of products, which would violate commitments already made under the GATT. Office personnel have been engaged in the preparation of documents and statistical data for use by U.S. negotiators.

Finally, members of the Office are significantly involved in the administration of the U.S. Generalized System of Preferences. The GSP, initially proposed in the United Nations Council on Trade and Development (UNCTAD) during the 1960's, is a program under which developed countries provide unilateral preferential tariff treatment to products imported from developing countries. The U.S. GSP was authorized by the Trade Act of 1974 and became effective on January 1, 1976; it was renewed through July 4, 1993, by the Trade and Tariff Act of 1984. Each year since its implementation, the Commission has provided a substantial amount of technical assistance in the operation of the GSP. In particular, Commission staff are involved in the annual TPSC review of the GSP, during which petitions are received from importers, U.S. producers, and foreign governments for changes in the list of products that are eligible for duty-free treatment under the GSP; the annual statistical analysis necessary for determining which countries may lose or regain eligibility for duty-free entry of specific products under the so-called competitive-need formula; the preparation of Presidential Executive orders to modify the GSP; and the preparation of an annual booklet providing a full and up-to-date listing of eligible articles and beneficiary countries.

Members of the Office of Tariff Affairs and Trade Agreements have also been involved in technical work during fiscal year 1984 concerning the recently enacted renewal of the GSP through July 1993.

For each of the products involved in the petitions accepted for review, the Commission is requested to conduct formal investigations under section 503(a) of the Trade Act of 1974 and section 332 of the Tariff Act of 1930 to advise the President of the probable economic effect on U.S. industries and consumers of the requested modifications. The Commission's advice in the 1983 review was submitted in November 1983, and work was in progress on advice in the 1984 review at the end of fiscal year 1984.

Office of Data Systems

The Commission maintains a comprehensive data collection, manipulation, and storage capability to support its multifaceted trade mission activities. The Office of Data Systems, through the functions performed by its library, data processing, and statistical staffs, carries out the Commission's responsibility in this area.

The Automated Data Processing (ADP) staff develops and maintains a number of computerized information systems used in generating a variety of trade statistics and maintains an extensive collection of import and export data in its magnetic tape library. These information systems, together with several administrative support systems, are loaded in an in-house IBM 4331 computer and the National Institute of Health Computer Center's System 370, which together account for the bulk of the agency's computer resource.

The Statistical Services Division (SSD) staff is able to stay abreast of the constant need for reliability in trade statistics by using computers and improved access methods, including microfiche readers. SSD statisticians provide input to many of the Commission's prehearing reports (approximately 110 in 1984) and respond to daily

inquiries for data from trade statistics' users both in and out of Government.

The Main Library completes the trade statistics information triangle by maintaining published hard-copy data for many of the computerized sources generated and used throughout the Commission. Much of this hard-copy backup is in the form of published Census statistics on imports and exports, including an extensive micrographics collection. Also included among the Main Library's information resource capability are several computer terminals used for acquiring and cataloging publications and accessing the commercial data bases currently used in Commission work, which together with the other sources available within the Office of Data Systems provide a complete cross-reference to most of the traditional trade statistics used in the Federal Government. The Main Library makes extensive use of the nationwide On-Line Computer Library Center library network to support its acquisition, cataloging, and interlibrary loan activities.

Office of Congressional Liaison

During fiscal year 1984, trade policy became a major issue in Congress, as several trade measures were considered in both Houses of Congress. The five section 201 investigations brought before the Commission generated a high level of congressional interest in the Commission's activities. The Office of Congressional Liaison is responsible for coordinating Commission services to the Congress and informing the Commission of relevant congressional action.

A major activity of the Office was responding to congressional inquiries. Over 1,000 calls and 500 letters were received by the Office during the year. Congressional interest in the Commission was also reflected in the 42 appearances by Members of

Congress at Commission hearings. The Office also provided periodic reports to the Commission on the status of trade legislation and on congressional hearings and meetings on trade issues.

Another important function of the Office was to coordinate the Commission's actions regarding legislation that would transfer the ITC Building from the Commission to the Smithsonian Institution. At the close of the fiscal year, the bill had passed the House of Representatives and was pending in the Senate.

In addition to the activities of the Office of Congressional Liaison, the Commission provided a wide range of services to the Congress. Chairwoman Stern and Commissioner Eckes testified at 11 congressional hearings during the year. The Commission also completed reports on 137 bills introduced in the House and Senate. These reports, which are prepared for the House Ways and Means and Senate Finance Committees, provide statistical and legal background information for use in committee meetings.

Office of the Secretary

The Secretary to the Commission is responsible for compiling and maintaining the Commission's official records. The Office of the Secretary functions as the point of entry where petitions, briefs, and other legal documents are received from parties, embassies, the public, and other Government agencies; it also serves as the point of issuance for the Commission's notices, reports, and orders relating to the conduct of investigations. The Secretary's position is the only one in the agency besides those of the six Commissioners established by law. The Secretary's responsibilities include the management of a large volume of paperwork and detail. During fiscal year 1984, parties made a total of 13,000 filings in connection with agency investigations. This represented an increase of 32 percent over filings in fiscal year 1983.

The Secretary also schedules and participates in all Commission meetings and hearings. The Office staff must plan and coordinate work relating to transcripts or tape recordings of the proceedings, witness lists, the timing of testimony, and the display of exhibits before the Commission. When the Commission travels to another location for a hearing, the staff makes the arrangements. The Commission held 56 meetings and 67 days of hearings in fiscal year 1984.

An additional function of the Office of the Secretary is, as an outgrowth of its recordkeeping responsibility, to serve as the depository for historical information relating to the Commission's development as an institution since its inception in 1916.

The Secretary is responsible for administering requests for confidential treatment of proprietary information, requests for information issued under protective orders, and requests for information under the Freedom of Information Act. The Commission's Rules of Practice and Procedure (19 CFR 201.6) describe confidential information and the Commission's rationale for maintaining the confidentiality of proprietary business information. Examples of information the Commission considers to be eligible for confidential treatment are data relating to secrets, sales, shipments, profit, or employment of individual firms. The rationale for maintaining the confidentiality of such data is twofold. Disclosure would have the effect of either (1) impairing the Commission's ability to obtain information necessary to perform its statutory functions or (2) causing substantial harm to the competitive position of the entity from which such information was obtained. The Secretary considered 521 such requests during fiscal year 1984, representing a 29-percent increase over the number in fiscal year 1983.

Under the Commission's rules (19 CFR 207.7), counsel for parties involved in legal actions at the Commission may apply for the release of confidential information under a protective order. This practice is administered by the Secretary. The Secretary considered 83 such requests during fiscal year 1984, or 12 percent more than in fiscal year 1983. A total of 73 requests were granted.

The Commission's rules (19 CFR 201.17-201.21) provide for requests for information under the Freedom of Information Act (5 U.S.C. 552). Essentially, the act supports the public's right of access to Government records except under explicit exceptions. At the Commission, most denials of access to information involve information that is business confidential, involve personnel matters, or relate to pre-determination staff advice to the Commission. Under the Commission's rules, the determination as to each request is made by the Secretary. The Secretary considered 192 such requests during fiscal year 1984, 14 percent fewer than in fiscal year 1983. Of the requests received, 97 were granted in part and denied in part; the remainder either were granted in their entirety or the agency had no records of the type requested.

The Commission's Public and Consumer Affairs Office is a branch of the Office of the Secretary. The Public and Consumer Affairs Office has the dual role of administering the Commission's media relations program and aiding teachers, students, historians, foreign visitors, consumers, and other interested members of the public in understanding Commission activities. In this respect, the Public Affairs staff publishes press releases, brochures, media advisories, and other materials; briefs members of the press; and answers frequent inquiries from the public. The Commission's need for a professional public affairs component has risen with the growing media and public attention to trade issues during the past several years.

Office of Administration

During fiscal year 1984, the Office of Administration concentrated its efforts in financial management improvement and human resource development, preparing to add 10 percent more permanent staff to the Commission and planning for the physical relocation of the Commission.

Considerable time was devoted to installing an in-house financial management capability tailored to the needs of the Commission's cost center managers. The new capability was in operation on April 1, 1984. Additionally, in the financial management area, procedures for implementing a system to comply with the provisions of the Federal Managers' Financial Integrity Act were well in place by early fiscal year 1984.

During fiscal year 1984, 14 employees participated in the Commission's Executive and Managerial Development Program. This program provides special training for individuals selected as potential members of the Senior Executive Service and for other employees now in managerial positions or expected to fill such positions in the future. The Commission's seven Senior Executive Service members participated in executive training required annually for all Senior Executives. In addition, provisions were implemented to establish a continuing development requirement for the Commission's merit pay managers. Also critical to the Commission's operations was the extensive use of word-processing training for support and professional staff. During fiscal year 1984, 187 of the Commission's staff took on-site courses administered by a trainer under contract with the Commission. Of the 187 trained, 75 percent were support personnel and 25 percent were professional staff members.

Commission employees were recognized for their work accomplishments during the fiscal year. Fiscal year 1984 saw 131 incentive awards, including 42 Quality Step Increases, 36 Special Achievement Awards, 52 Sustained Superior Performance Awards, and one Commissioners' Award for Exceptional Service.

The International Trade Commission Building at 701 E Street NW., Washington, DC, where most of the Commission's staff is located, remains in deplorable condition and is long overdue for basic repairs and alterations. The building is over 140 years old, and the Commission and its predecessor, the U.S. Tariff Commission, have made the building headquarters since 1921. A significant amount of time was spent during fiscal year 1984 attempting to persuade the General Services Administration to repair the facility. A new roof was finally installed, but the roof drain system remains unrepaired, resulting in office ceilings and interior walls continuing to deteriorate. The substructure of the building's inner courtyard continues to deteriorate, and the building's exterior masonry shows many cracks, with large pieces falling to

the ground. Many of the building's windows and frames need to be replaced. There is no central heating and ventilation system, and electrical power within the building is insufficient in several areas.

On June 29, 1983, the U.S. Senate passed legislation (S. 1287) that would transfer the ITC Building to the Smithsonian Institution for museum and related purposes without reimbursement and direct the General Services Administration to relocate the Commission to another facility in downtown Washington, DC, approved by the GSA and the Commission Chairman. The legislation also would direct the General Services Administration to maintain the ITC Building to prevent further deterioration and to ensure occupant safety until the building is transferred to the Smithsonian. Similar legislation was introduced in the U.S. House of Representatives on September 28, 1983, and as of the end of fiscal year 1984, it was progressing toward enactment.

Part III. Management and Finance

The Commission

The six Commissioners of the United State International Trade Commission are appointed by the President and confirmed by the U.S. Senate for terms of 9 years, unless appointed to fill an unexpired term. A Commissioner who has served for more than 5 years is not eligible for reappointment. Not more than three Commissioners may be members of the same political party.

The Chairman is designated by the President and serves for a 2-year term. No Chairman may be of the same political party as the preceding Chairman, nor may the President designate two Commissioners of the same political party as the Chairman and Vice Chairman.

At the close of fiscal year 1984, there were five Commissioners: Paula Stern, Chairwoman; Susan W. Liebeler, Vice Chairman; and Alfred E. Eckes, Seeley G. Lodwick, and David B. Rohr. In addition,

Veronica A. Haggart served as a Commissioner until June 16, 1984.

Paula Stern, Democrat of the District of Columbia. Dr. Stern's term expires June 16, 1987.

Susan W. Liebeler, Independent of California. Ms. Liebeler's term expires December 16, 1988.

Alfred E. Eckes, Republican of Virginia. Mr. Eckes' term expires June 16, 1990.

Seeley G. Lodwick, Republican of Iowa. Mr. Lodwick's term expires December 16, 1991.

David B. Rohr, Democrat of Maryland. Mr. Rohr's term expires December 16, 1985.

Executive Staff

The executive staff of the Commission at the close of fiscal year 1984 was as follows:

Office of the Administrative Law Judges Acting Chief Administrative Law Judge	Janet D. Saxon
Office of Congressional Liaison, Director	Thomas D. Gallagher
Office of the Secretary Secretary	Kenneth R. Mason
Assistant Secretary/ Public and Consumer Affairs Officer	Harold W. Sundstrom
Office of Executive and International Liaison, Director	William T. Hart
Office of the General Counsel General Counsel	Michael H. Stein
Assistant General Counsel for Litigation and Special Projects	Michael Mabile
Assistant General Counsel for Antidumping and Countervailing Duty Investigations	Vacant
Assistant General Counsel for Section 337 Investiga- tions	N. Timor Yaworski
Assistant General Counsel for Escape-Clause, Section 22, and Section 332 Investigations	William W. Gearhart
Office of Operations, Director	William E. Fry, Acting
Office of Data Systems, Director	Michael J. Olsavsky
Office of Economics, Director	John Suomela
Office of Industries, Director	Norris A. Lynch
Chiefs of Divisions:	
Agriculture, Fisheries, and Forest Products	David Ingersoll
Minerals and Metals	Larry L. Brookhart
Energy and Chemicals	John Gersic
Textiles, Leather Products, and Apparel	Reuben I. Schwartz
Machinery and Equipment	Aaron H. Chesser
General Manufactures	Walter S. Trezevant
Office of Investigations, Director	Lynn Featherstone, Act- ing
Supervisory Investigator	Vera Libeau
Supervisory Investigator	Robert Eninger
Supervisory Investigator	Robert Carpenter
Unfair Import Investigations Division, Acting Chief	Arthur Wineburg
Office of Tariff Affairs and Trade Agreements, Director	Eugene A. Rosengarden
Office of Administration, Director	Lorin L. Goodrich
Office of Finance and Budget, Director	Richard D. Arnold
Office of Management Services, Director	David E. Spencer
Office of Personnel, Director	Terry P. McGowan

The ALJ's conduct formal proceedings in section 337 investigations, exercise independent judgment according to the Administrative Procedure Act, and transmit determinations to the Commission for its consideration in rendering a final decision.

The Director, Office of Congressional Liaison, acts as a point of contact for the Commission with the Congress, nonexecutive Federal agencies, State and local agencies, and international organizations and associations involved in international trade.

The Secretary maintains the official records and documents for the Commission. The Secretary keeps the minutes of, and assists in, the conduct of all Commission meetings and is responsible for the issuance of public notices and information. The Assistant Secretary/Public and Consumer Affairs Officer in the Office of the Secretary is responsible for media relations and consumer affairs.

The Director, Office of Executive and International Liaison, coordinates Commission activities and assistance to the United States Trade Representative, other officials in the Executive Office of the President, and executive departments and keeps the Commission informed of trade issues and policy formulation regarding bilateral and multilateral trade agreements.

The General Counsel is the Commission's chief legal officer and adviser.

The Director, Office of Operations, is responsible for the coordination, direction, and control of the investigative, analytical, and research work of the Commission. The Offices of Data Systems, Economics, Industries, Investigations, and Tariff Affairs and Trade Agreements report to the Director of Operations.

The Director, Office of Administration, is responsible for the coordination, direction, and control of the administrative and management functions and programs of the Commission, including personnel,

accounting, budget, management analysis, administrative services, and publications services. The Offices of Finance and Budget, Management Services, and Personnel report to the Director of Administration.

Employment and Appropriations

The level of permanent full-time staff at the end of fiscal year 1984 was higher than that at the end of fiscal year 1983. There were 436 permanent employees on board on September 30, 1984, compared with 399 on September 30, 1983. This increase in employment reflected the beginning of a program to hire additional staff to handle the Commission's growth in workload. Congress authorized 44 additional permanent positions in 1984, increasing the Commission's personnel ceiling from 438 to 482. Supplemental funds were appropriated in August 1984 to begin filling these positions. Congress also appropriated a funding level for fiscal year 1985 that would maintain the newly authorized personnel strength.

To do the work mandated by the Congress, the Commission maintains an expert staff of professional commodity and nomenclature analysts, investigators, attorneys, economists, data system programmers, and administrative support personnel. These include nationally and internationally recognized experts—a skilled grouping of men and women who constantly monitor their fields for developments that affect U.S. policy and trade interests.

The following tabulation shows the number of permanent officers and employees of the Commission by organizational units at the close of fiscal year 1984:

Organizational unit	Sept. 30, 1984
Commissioners	5
Offices of the Commissioners	20
Office of the Administrative Law Judges	11
Office of the Secretary	17
Office of Executive and International Liaison	4
Office of Congressional Liaison	3
Office of the General Counsel	30
Office of the Director of Operations	2
Office of Data Systems	36
Office of Economics	35
Office of Industries	134
Office of Investigations	46
Office of Tariff Affairs and Trade Agreements	24
Office of the Director of Administration	2
Office of Finance and Budget	11
Office of Management Services	36
Office of Personnel	12
Upward Mobility Program	8
Total	436

The U.S. International Trade Commission submits its budget directly to the Congress.¹ During fiscal year 1984, appropriated funds made available to the Commission amounted to \$21,488,000. Reimbursements received totaled \$90,000, making available a grand total of \$21,578,000. Obligations for fiscal years 1983 and 1984 were as follows (in thousands of dollars):

Item	Fiscal year 1983	Fiscal year 1984
Salaries and personnel benefits	\$14,430	\$15,880
Travel and transportation	290	422
Rental and communications services	1,797	2,345
Other services	1,464	1,167
Printing and reproduction	325	291
Equipment, supplies, and material	1,144	1,237
Total	19,450	21,342

A majority of the Commission's employees are housed in the historic U.S. International Trade Commission Building, 701 E Street NW., Washington, DC. Designed by Robert Mills (who also designed

¹Because of the unique role of the Commission as a quasi-judicial, bipartisan, and independent agency designed to provide trade expertise to both legislative and executive branches of Government, Congress provided in sec. 175 of the Trade Act of 1974 (19 U.S.C. 2232) that the budget of the U.S. International Trade Commission would not be subject to control by the Office of Management and Budget, but would instead be submitted directly to the Congress.

the Treasury Building and the Washington Monument), it was built from 1839 to 1860 under the supervision of Thomas U. Walter, one of the architects of the Capitol. The building was first occupied by the Commission in 1921. Through the first century of its service, the building housed the Postmaster General, the General Land Office, the Bureau of Education, the National Selective Draft Board, the Panama Canal Commission, and General John J. Pershing.

Owing to space limitations at the U.S. International Trade Commission Building, approximately 18 percent of the Commission's employees on September 30, 1984, were located at the Bicentennial Building, 600 E Street NW., Washington, DC, and the Interstate Commerce Commission Building, 12th and Constitution Avenue NW., Washington, DC.

Sources of Information

In addition to its statutory obligations to conduct public investigations, the Commission assists the legislative and executive branches of Government and responds to inquiries from the news media and the public.

As the international economic trade research arm of the Government, the Commission maintains an 80,000-volume library, which receives about 2,400 periodicals annually. The library, located in room 301 of the ITC Building, houses not only publications on international trade and U.S. tariff and commercial policy but also many business and technical journals.

The Commission's Office of the General Counsel maintains a law library and a comprehensive file of documents on legislation affecting U.S. trade. The law library is located in room 213 of the ITC Building.

The Commission's Office of Data Systems maintains a comprehensive computer tape library consisting of historical trade data developed from the Department of Commerce import/export statistics, related descriptive information for a variety of commodity classification groups, and computerized files used in preparing many of the reports issued by the Commission.

Facilities for research by the public are located in the Office of the Secretary, room 156, and in the Commission libraries. Inquiries should be directed to the specific organizational unit or to the Secretary, U.S. International Trade Commission, 701 E Street NW., Washington, DC 20436, telephone 202-523-0161. Publications may be ordered 24 hours a day, 7 days a week, by calling 202-523-5178.

International Trade Commission

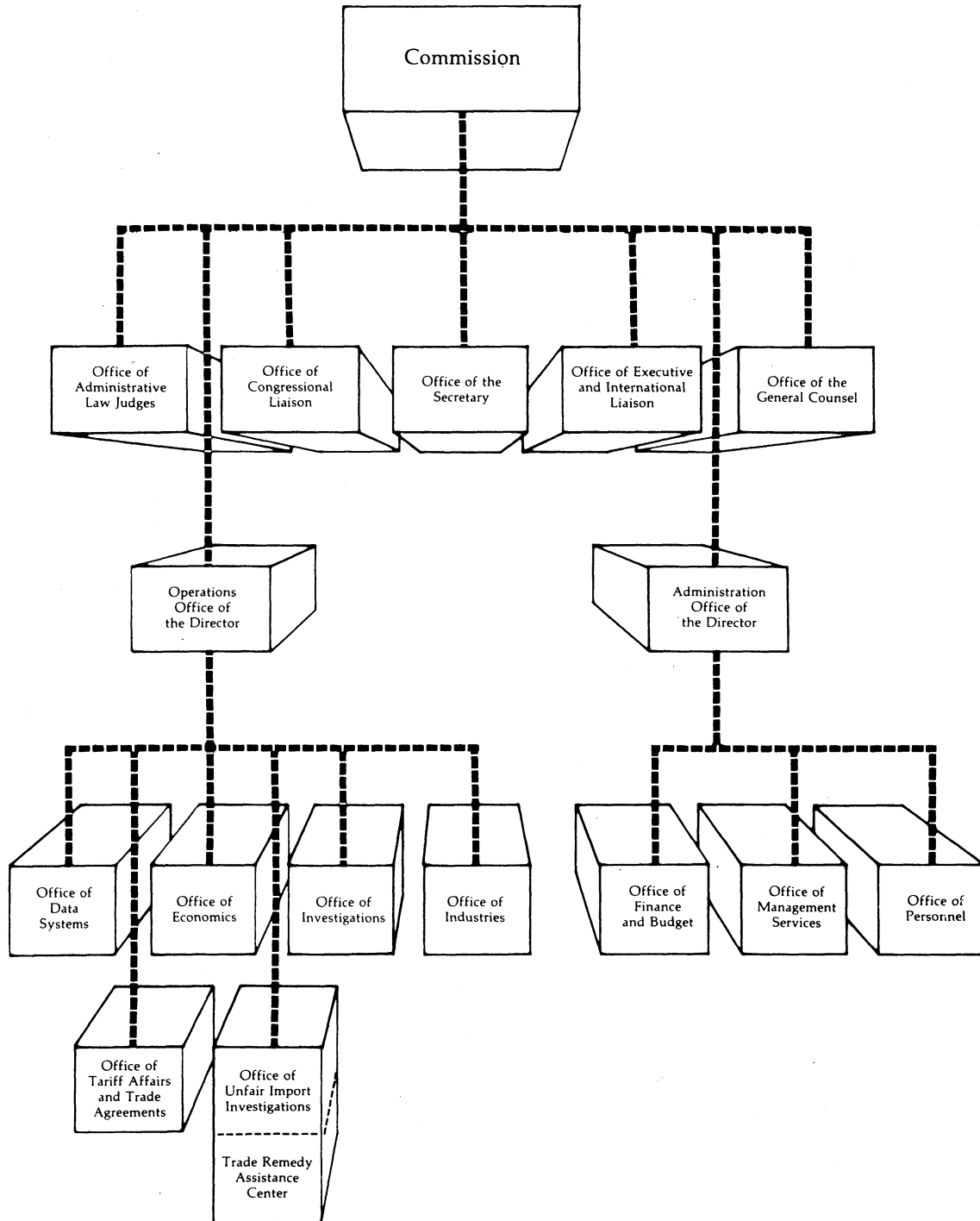

Appendix A

Summary of Principal Activities of the U.S. International Trade Commission, Fiscal Years 1981-84

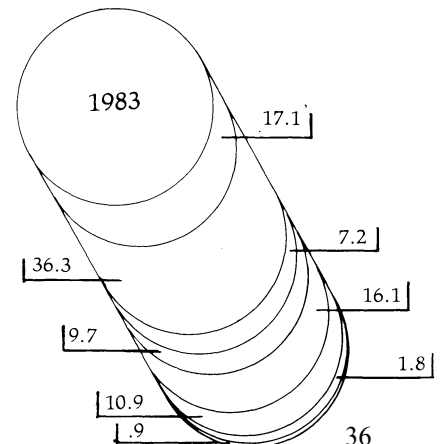
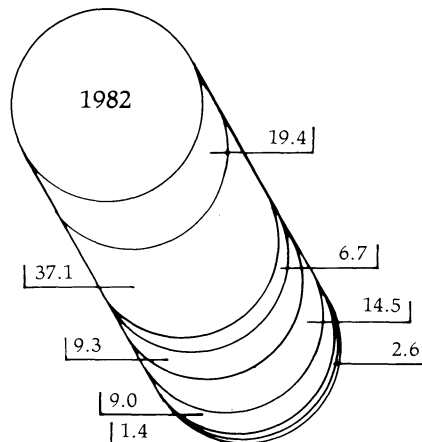
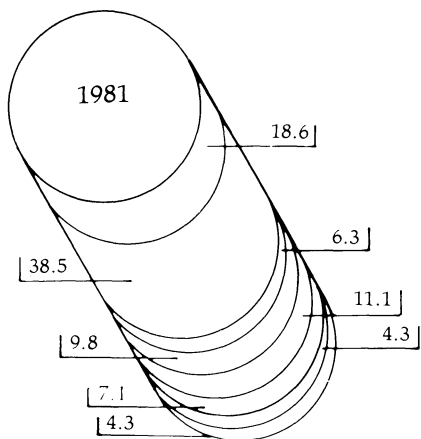
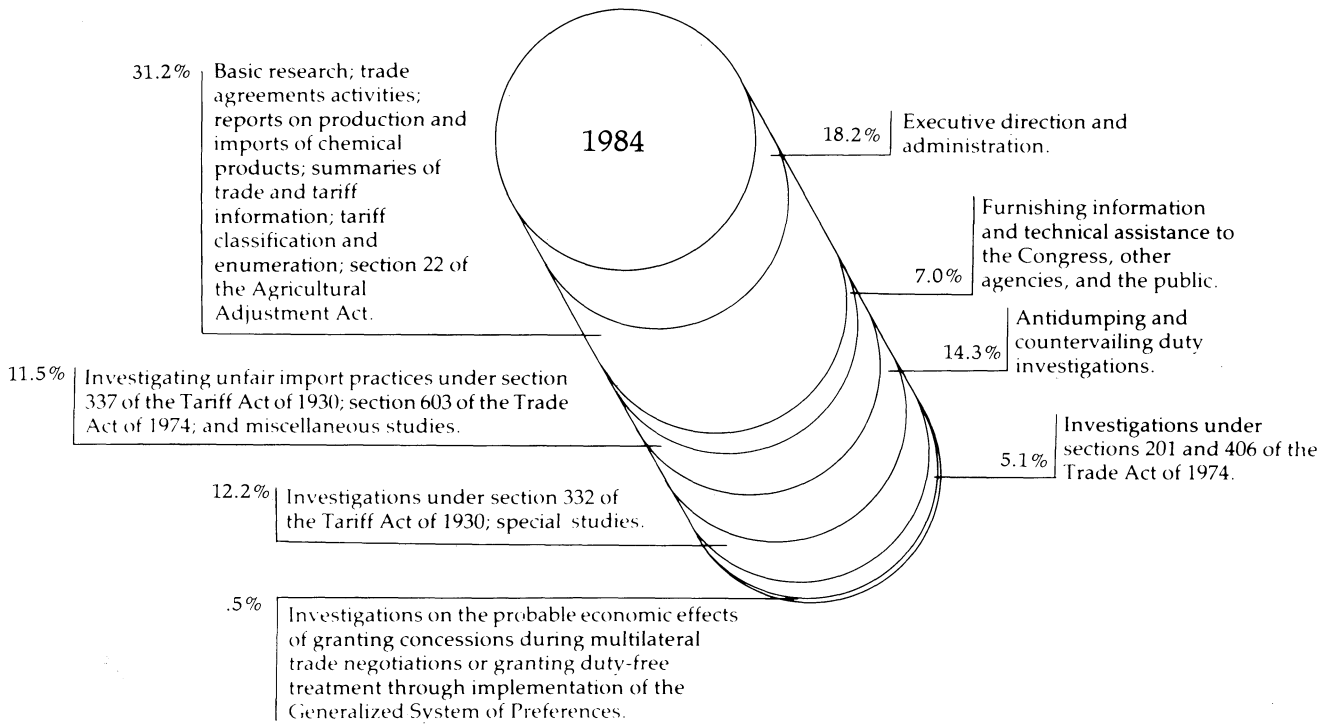

Appendix B

Summary of Investigations Completed During Fiscal Year 1984 and Pending on September 30, 1984

Table 1

"Escape clause" investigations completed under sec. 201 of the Trade Act of 1974, fiscal year 1984

Investigation No.	Article concerned	Petitioner or requester	Petition or request filed	Public hearing	Finding of Commission	Commissioners' votes			Commission's report	
						Affirmative	Negative	Not participating	To the President	USITC Publication No.
TA-201-49	Stainless steel table flatware.	Stainless Steel Flatware Manufacturers Association.	12-13-83	3-29-84	Negative	—	Eckes Stern Haggart Lodwick Rohr	Liebeler ¹	6-13-84	1536
TA-201-50	Nonrubber footwear	Footwear Industries of America, Inc., Amalgamated Clothing & Textile Workers Union, AFL-CIO, and United Food & Commercial Workers International Union, AFL-CIO.	1-23-84	5-2-84 to 5-4-84	Negative	—	Eckes Stern Lodwick Liebeler Rohr	Haggart ²	7-9-84	1545
TA-201-51	Carbon and certain alloy steel products.	The United Steelworkers of America, AFL-CIO/CLC, and Bethlehem Steel Corp.	1-24-84	5-9-84 to 5-11-84	Affirmative ³	Eckes ⁴ Lodwick ⁵ Rohr ⁴	Eckes ⁶ Stern Lodwick ⁶ Liebeler Rohr ⁶	Haggart ²	7-24-84	1553
TA-201-52	Unwrought copper	Anaconda Minerals Co., Asarco Inc., Copper Range Co., Cyprus Mines Corp., Duval Corp., Inspiration Consolidated Copper Co., Kennecott Corp., Magma Copper Co., Phelps Dodge Corp., Pinto Valley Copper Corp., and Ranchers Exploration & Development Corp.	1-26-84	5-15-84 to 5-17-84	Affirmative	Stern ⁷ Eckes ⁸ Lodwick ⁸ Liebeler ⁹ Rohr ⁷	—	Haggart ¹⁰	7-16-84	1549
TA-201-53	Certain canned tuna fish	The United States Tuna Foundation; C.H.B. Foods, Inc.; the American Tuna Boat Association; the United Industrial Workers, AFL-CIO; the Fishermen's Union of America, AFL-CIO; the Fishermen's Union, ILWU, No. 33.	2-14-84	6-5-84	Negative	Stern	Liebeler Eckes Lodwick Rohr	—	8-15-84	1558

¹Commissioner Liebeler assumed her duties on Apr. 20, 1984, and was not a Commissioner during most of the investigative period.

²Commissioner Haggart did not participate in the vote in order to avoid any possibility or appearance of conflict of interest.

³On July 11, 1984, the Commission determined that it would recommend to the President that he impose quantitative restrictions and increased duties on imports of certain carbon and alloy steel products for a 5-year period. 3 Commissioners recommended tariffs and quotas, and 2 Commissioners recommended that the President impose no relief.

⁴With respect to ingots, blooms, billets, slabs, and sheet bars; plates; sheets and strip; wire and wire products; structural shapes and units; and pipes, tubes, and blanks.

⁵With respect to ingots, blooms, billets, slabs and sheet bars; plates; sheets and strip; wire and wire products; and structural shapes and units.

⁶With respect to imports of wire rod, railway-type products, and bars.

⁷Recommended a tariff increase of 5 cents per pound in addition to the existing rate of duty on imports of refined copper and blister copper for a period of 5 years.

⁸Recommended that the President impose quantitative restrictions for a 5-year period in an aggregate amount of 425,000 short tons per year. Imports of refined copper will be restricted to 375,000 short tons, of which 25,000 short tons per year will be reserved for imports of wire bar. Imports of blister copper will be restricted to 50,000 short tons per year.

⁹Recommended no relief.

¹⁰Commissioner Haggart did not participate because she would no longer be at the Commission at the time of the final vote.

Table 2

“Market disruption” investigation completed under sec. 406 of the Trade Act of 1974, fiscal year 1984

Investigation No.	Article concerned	Petitioner or requester	Petition or request filed	Public hearing	Finding of Commission	Commissioners' votes		Commission's report	
						Affirmative	Negative	To the President	USITC Publication No.
TA-406-10	Ferrosilicon from the Soviet Union.	United States Trade Representative.	11-2-83	1-6-84	Negative	Eckes	Stern Haggart Lodwick	2-2-84	1484

Table 3

Antidumping investigations completed under sec. 731 of the Tariff Act of 1930, fiscal year 1984

Investigation No.	Article concerned	Preliminary investigation				Final investigation					
		(a) Request received (b) Conference (c) Report to Secretary of Commerce	Finding that “there is a reasonable indication [of injury]” (Commerce continues its investigation)	Finding that “there is no reasonable indication [of injury]” (Commerce terminates its investigation)	Not participating	USITC Publication No.	(a) Advice received from Commerce (b) Hearing (c) Report to Secretary of Commerce	Affirmative	Negative	Not participating	USITC Publication No.
731-TA-44 ¹	Sorbitol from France.	—	—	—	—	—	(a) 7-18-83 (b) 9-19-83 (c) 10-17-83	Eckes Stern ² Haggart ² Lodwick ²	Stern ³ Haggart ³ Lodwick ³	—	1441
731-TA-108 and 731-TA-109.	Portland cement from Australia and Japan.	—	—	—	—	—	(a) 4-29-83 (b) 9-12-83 (c) 10-20-83	—	Eckes Stern Haggart Lodwick	—	1440
731-TA-113	Carbon steel wire rod from Brazil.	—	—	—	—	—	(a) 5- 4-83 (b) 7-12-83 (c) 10-31-83	Eckes Stern Haggart Lodwick	—	—	1444
731-TA-114	Carbon steel wire rod from Trinidad and Tobago.	—	—	—	—	—	(a) 5- 4-83 (b) 7-12-83 (c) 10-31-83	Eckes Stern Haggart Lodwick	—	—	1444
731-TA-116 and 731-TA-117.	Carton-closing staples and non-automatic carton-closing staple machines from Sweden.	—	—	—	—	—	(a) 6- 2-83 (b) 8-11-83 (c) 12- 2-83	Eckes Haggart Lodwick	Stern	—	1454
731-TA-118	Certain lightweight polyester filament fabric from Japan.	—	—	—	—	—	(a) 8- 8-83 (b) 10-27-83	—	—	—	Terminated 1-26-84.
731-TA-119	Certain lightweight polyester filament fabric from the Republic of Korea.	—	—	—	—	—	(a) 8- 8-83 (b) 10-27-83 (c) 12- 5-83	—	Eckes Stern Haggart Lodwick	—	1457
731-TA-120 and 731-TA-122.	Certain tapered roller bearings and parts thereof from Japan.	—	—	—	—	—	(a) 8-30-83 (b) 1-25-84 (c) 2-27-84	—	Eckes Stern Lodwick	Haggart ⁴	1497

See footnotes at end of table.

Table 3—Continued

Antidumping investigations completed under sec. 731 of the Tariff Act of 1930, fiscal year 1984

Investigation No.	Article concerned	Preliminary investigation				Final investigation						
		(a) Request received (b) Conference (c) Report to Secretary of Commerce	Finding that "there is a reasonable indication [of injury]" (Commerce continues its investigation)	Finding that "there is no reasonable indication [of injury]" (Commerce terminates its investigation)	Not participating	USITC Publication No.	(a) Advice received from Commerce (b) Hearing (c) Report to Secretary of Commerce	Affirmative	Negative	Not participating	USITC Publication No.	
731-TA-123	Certain flat-rolled carbon steel products from Brazil.	—	—	—	—	—	(a) 9- 7-83 (b) 1-31-84 (c) 3- 5-84	Eckes Stern Haggart Lodwick	—	—	—	1499
731-TA-124	Certain fresh potatoes from Canada.	—	—	—	—	—	(a) 8- 2-83 (b) 11-18-83 (c) 12-19-83	—	Eckes Stern Lodwick	Haggart ²	—	1463
731-TA-125	Potassium permanganate from the People's Republic of China.	—	—	—	—	—	(a) 8- 9-83 (b) 12- 2-83 (c) 1-20-84	Eckes Stern Haggart Lodwick	—	—	—	1480
731-TA-126	Potassium permanganate from Spain.	—	—	—	—	—	(a) 8- 9-83 (b) 12- 2-83 (c) 1- 5-84	Eckes Stern Haggart Lodwick	—	—	—	1474
731-TA-130	Chloropicrin from the People's Republic of China.	—	—	—	—	—	(a) 9-19-83 (b) 2- 9-84 (c) 3-19-84	Eckes Stern Haggart Lodwick	—	—	—	1505
731-TA-131 and 731-TA-132.	Certain welded carbon steel pipes from the Republic of Korea and Taiwan.	—	—	—	—	—	(a) 10-28-83 (b) 3-27-84 (c) 4-25-84	Eckes Stern ⁵ Haggart Lodwick	Stern ⁶	Rohr ⁷ Liebeler ⁸	—	1519
731-TA-134 and 731-TA-135.	Color television receivers from the Republic of Korea and Taiwan.	—	—	—	—	—	(a) 10-19-83 (b) 3- 8-84 (c) 4- 9-84	Eckes Stern Haggart Lodwick	—	Rohr ⁷	—	1514
731-TA-136	Cyanuric acid and its chlorinated derivatives from Japan.	—	—	—	—	—	(a) 11-18-83 (b) 3-14-84 (c) 4- 9-84	Eckes Haggart	Stern	Rohr ⁷	—	1513
731-TA-138	Certain rectangular welded carbon steel pipes and tubes from the Republic of Korea.	—	—	—	—	—	(a) 10-28-83 (b) 3- 7-84 (c) 4-27-84	Eckes ⁹ Haggart ⁹ Lodwick ⁹	Eckes ¹⁰ Stern Haggart ¹⁰ Lodwick ¹⁰	Rohr ⁷ Liebeler ⁸	—	1519
731-TA-139	Acrylic sheet from Taiwan.	—	—	—	—	—	(a) 1-11-84 (b) 4-12-84 (c) 5- 9-84	—	Eckes Stern Haggart Lodwick Rohr	Liebeler ¹¹	—	1525
731-TA-145	Certain steel valves and parts thereof from Japan.	(a) 9-22-83 (b) 10-17-83 (c) 11- 7-83	Eckes Stern Haggart Lodwick	—	—	1446	(a) 4- 2-84 (b) 6-19-84 (c) 7-30-84	Eckes	Stern Liebeler Lodwick Rohr	—	—	1556
731-TA-146 and 731-TA-147.	Certain flat-rolled carbon steel products from Belgium and the Federal Republic of Germany.	(a) 9-29-83 (b) 10-26-83 (c) 11-14-83	Eckes Stern Haggart Lodwick	—	—	1451	—	—	—	—	—	—

See footnotes at end of table.

Table 3—Continued

Antidumping investigations completed under sec. 731 of the Tariff Act of 1930, fiscal year 1984

Investigation No.	Article concerned	Preliminary investigation				Final investigation					
		(a) Request received (b) Conference (c) Report to Secretary of Commerce	Finding that "there is a reasonable indication [of injury]" (Commerce continues its investigation)	Finding that "there is no reasonable indication [of injury]" (Commerce terminates its investigation)	Not participating	USITC Publication No.	(a) Advice received from Commerce (b) Hearing (c) Report to Secretary of Commerce	Affirmative	Negative	Not participating	USITC Publication No.
731-TA-147 (court remand).	Cut-to-length carbon steel plate from the Federal Republic of Germany.	(a) 9-29-83 (b) 10-26-83 (c) 11-14-83	Stern Eckes Lodwick Liebeler Rohr	—	—	1550	—	—	—	—	—
731-TA-148	Fresh cut roses from Colombia.	(a) 9-30-83 (b) 10-24-83 (c) 11-14-83	Eckes Lodwick	Stern	—	1450	(a) 3-14-84 (b) 7-30-84 (c) 9-10-84	Eckes	Stern Lodwick Rohr	Haggart * Liebeler ¹²	1575
731-TA-149	Barium chloride from the People's Republic of China.	(a) 10-25-83 (b) 11-15-83 (c) 12- 9-83	Eckes Stern Haggart Lodwick	—	—	1458	(a) 4- 6-84 (b) 8-23-84 (c) 10- 4-84	Stern Liebeler Eckes Lodwick Rohr	—	—	1584
731-TA-150	Barium carbonate from the People's Republic of China.	(a) 10-25-83 (b) 11-15-83 (c) 12- 9-83	Eckes Stern Haggart Lodwick	—	—	1458	—	—	—	—	—
731-TA-151	Certain hot-rolled carbon steel plate from the Republic of Korea.	(a) 10-31-83 (b) 11-22-83 (c) 12-15-83	Eckes Stern Haggart Lodwick	—	—	1459	(a) 4-12-84 (b) 6-29-84 (c) 8- 9-84	Liebeler Eckes Lodwick Rohr	Stern	—	1561
731-TA-152	Pads for woodwind instrument keys from Italy.	(a) 11- 7-83 (b) 11-30-83 (c) 12-21-83	Eckes Stern Haggart Lodwick	—	—	1466	(a) 4-25-84 (b) 7-12-84 (c) 8-23-84	Eckes Lodwick Rohr	Stern Liebeler	—	1566
731-TA-153	Hot-rolled carbon steel sheet from Brazil.	(a) 11-10-83 (b) 12- 7-83 (c) 12-27-83	Eckes Stern Haggart Lodwick	—	—	1470	(a) 4-26-84 (b) 7-26-84 (c) 8-23-84	Stern Eckes Lodwick Rohr	Liebeler	—	1568
731-TA-154	Certain carbon steel products from Brazil.	(a) 11-10-83 (b) 12- 7-83 (c) 12-27-83	Eckes Stern Haggart Lodwick	—	—	1470	(a) 7-11-84 (b) 8-16-84 (c) 8-23-84	—	Stern Liebeler Eckes Lodwick Rohr	—	1579
731-TA-155 and 731-TA-156.	Choline chloride from Canada and the United Kingdom.	(a) 11-15-83 (b) 12- 8-83 (c) 12-30-83	Eckes Stern Haggart Lodwick	—	—	1473	—	—	—	—	—
731-TA-157, 731-TA-158, and 731-TA-160.	Carbon steel wire rod from Argentina, Mexico, and Spain.	(a) 11-23-83 (b) 12-14-83 (c) 1- 9-84	Eckes Stern Haggart Lodwick	—	—	1476	—	—	—	—	—
731-TA-159	Carbon steel wire rod from Poland.	(a) 11-23-83 (b) 12-14-83 (c) 1- 9-84	Eckes Stern Haggart Lodwick	—	—	1476	(a) 5- 8-84 (b) 7-31-84 (c) 9- 4-84	—	Stern	Liebeler Eckes Lodwick Rohr	1574
731-TA-161 and 731-TA-162.	Titanium sponge from Japan and the United Kingdom.	(a) 11-28-83 (b) 12-20-83 (c) 1-12-84	Eckes Stern Haggart Lodwick	—	—	1477	—	—	—	—	—

See footnotes at end of table.

Table 3—Continued

Antidumping investigations completed under sec. 731 of the Tariff Act of 1930, fiscal year 1984

Investigation No.	Article concerned	Preliminary investigation				Final investigation						
		(a) Request received (b) Conference (c) Report to Secretary of Commerce	Finding that "there is a reasonable indication [of injury]" (Commerce continues its investigation)	Finding that "there is no reasonable indication [of injury]" (Commerce terminates its investigation)	Not participating	USITC Publication No.	(a) Advice received from Commerce (b) Hearing (c) Report to Secretary of Commerce	Affirmative	Negative	Not participating	USITC Publication No.	
731-TA-163	Certain cell-site radio apparatus and subassemblies thereof from Japan.	(a) 12-29-83 (b) 1-20-84 (c) 2-13-84	Eckes Stern Haggart Lodwick	—	—	1488	—	—	—	—	—	—
731-TA-164	Stainless steel sheet and strip from Spain.	(a) 1-13-84 (b) 2- 6-84 (c) 2-27-84	Eckes Haggart Lodwick	Stern	—	1495	—	—	—	—	—	—
731-TA-165	Certain valves, nozzles, and connectors of brass from Italy for use in fire protection systems.	(a) 1-23-84 (b) 2-14-84 (c) 3- 8-84	Eckes Haggart Lodwick Stern	Stern ¹³	—	1500	—	—	—	—	—	—
731-TA-166	Bicycle tires and tubes from Taiwan.	—	—	—	—	—	(a) 1-20-84 (b) 4-17-84 (c) 5-21-84	Eckes Stern Haggart Lodwick Rohr	—	—	Liebeler *	1532
731-TA-167 and 731-TA-168	Certain table wine from France and Italy.	(a) 1-27-84 (b) 2- 1-84 (c) 3-12-84	—	Eckes Stern Lodwick	Haggart ⁴	1502	—	—	—	—	—	—
731-TA-169 through 731-TA-171	Carbon steel plate not in coils from Finland, South Africa, and Spain.	(a) 2-10-84 (b) 3- 7-84 (c) 3-26-84	Eckes Stern Haggart Lodwick	—	—	1510	—	—	—	—	—	—
731-TA-172 and 731-TA-173	Carbon steel plate in coils from South Africa and Spain.	(a) 2-10-84 (b) 3- 7-84 (c) 3-26-84	Eckes Stern Haggart Lodwick	—	—	1510	—	—	—	—	—	—
731-TA-174	Hot-rolled carbon steel sheet from South Africa.	(a) 2-10-84 (b) 3- 7-84 (c) 3-26-84	Eckes Stern Haggart Lodwick	—	—	1510	—	—	—	—	—	—
731-TA-175 through 731-TA-177	Cold-rolled carbon steel sheet from Argentina, South Africa, and Spain.	(a) 2-10-84 (b) 3- 7-84 (c) 3-26-84	Eckes Stern ¹⁴ Haggart Lodwick	Stern ¹⁵	—	1510	—	—	—	—	—	—

See footnotes at end of table.

Table 3—Continued

Antidumping investigations completed under sec. 731 of the Tariff Act of 1930, fiscal year 1984

Investigation No.	Article concerned	Preliminary investigation					Final investigation				
		(a) Request received (b) Conference (c) Report to Secretary of Commerce	Finding that "there is a reasonable indication [of injury]" (Commerce continues its investigation)	Finding that "there is no reasonable indication [of injury]" (Commerce terminates its investigation)	Not participating	USITC Publication No.	(a) Advice received from Commerce (b) Hearing (c) Report to Secretary of Commerce	Affirmative	Negative	Not participating	USITC Publication No.
731-TA-178 through 731-TA-180.	Galvanized carbon steel sheet from Australia, South Africa, and Spain.	(a) 2-10-84 (b) 3- 7-84 (c) 3-26-84	Eckes Stern Haggart Lodwick	—	—	1510	—	—	—	—	—
731-TA-181 and 731-TA-182.	Carbon steel angles, shapes, and sections from South Africa and Spain.	(a) 2-10-84 (b) 3- 7-84 (c) 3-26-84	Eckes Stern Haggart Lodwick	—	—	1510	—	—	—	—	—
731-TA-183	Large-diameter carbon steel welded pipes from Brazil.	(a) 3-21-83 (b) 4-16-84 (c) 5- 7-84	Eckes Stern Haggart Lodwick Rohr	—	Liebeler *	1524	—	—	—	—	—
731-TA-184 through 731-TA-187.	Potassium chloride from East Germany, Israel, Spain, and the U.S.S.R.	(a) 3-30-84 (b) 4-24-84 (c) 5-14-84	Eckes Haggart Lodwick Rohr	—	Stern ¹⁶ Liebeler *	1529	—	—	—	—	—
731-TA-188	Lamb meat from New Zealand.	(a) 4-18-84 (b) 5-10-84 (c) 6- 4-84	Haggart Lodwick	Eckes Stern Rohr Liebeler	—	1534	—	—	—	—	—
731-TA-189	Calcium hypochlorite from Japan.	(a) 4-25-84 (b) 5-18-84 (c) 6-11-84	Eckes Stern Haggart Lodwick Liebeler Rohr	—	—	1540	—	—	—	—	—
731-TA-190	Stainless steel wire cloth from Japan.	(a) 6- 1-84 (b) 6-22-84 (c) 7-16-84	Stern Eckes Lodwick	Liebeler Rohr	—	1552	—	—	—	—	—
731-TA-191 through 731-TA-195.	Oil country tubular goods from Argentina, Brazil, the Republic of Korea, Mexico, and Spain.	(a) 6-13-84 (b) 7- 6-84 (c) 7-30-84	Stern Liebeler Eckes Lodwick Rohr	—	—	1555	—	—	—	—	—
731-TA-196	Certain red raspberries from Canada.	(a) 7- 5-84 (b) 7-27-84 (c) 8-20-84	Stern Liebeler Eckes Lodwick Rohr	—	—	1565	—	—	—	—	—
731-TA-197 and 731-TA-198.	Certain welded carbon steel pipes and tubes from Brazil and Spain.	(a) 7-17-84 (b) 8- 8-84 (c) 8-31-84	Stern Liebeler ¹⁷ Eckes Lodwick Rohr	Liebeler ¹⁸	—	1569	—	—	—	—	—
731-TA-199	Certain dried salted codfish from Canada.	(a) 7-19-84 (b) 8-10-84 (c) 9- 4-84	Stern Eckes Lodwick Rohr	Liebeler	—	1571	—	—	—	—	—

See footnotes at end of table.

Table 3—Continued

Antidumping investigations completed under sec. 731 of the Tariff Act of 1930, fiscal year 1984

Investigation No.	Article concerned	Preliminary investigation				Final investigation					
		(a) Request received (b) Conference (c) Report to Secretary of Commerce	Finding that "there is a reasonable indication [of injury]" (Commerce continues its investigation)	Finding that "there is no reasonable indication [of injury]" (Commerce terminates its investigation)	Not participating	USITC Publication No.	(a) Advice received from Commerce (b) Hearing (c) Report to Secretary of Commerce	Affirmative	Negative	Not participating	USITC Publication No.
731-TA-200	Radial-ply tires for passenger cars from the Republic of Korea.	(a) 7-20-84 (b) 8-13-84 (c) 9- 4-84	—	Stern Liebeler Eckes Lodwick Rohr	—	1572	—	—	—	—	—
731-TA-201	Egg filler flats from Canada.	(a) 8- 3-84 (b) 8-24-84 (c) 9-17-84	Stern Liebeler Lodwick Rohr	—	Eckes ¹⁹	1577	—	—	—	—	—
731-TA-202 and 731-TA-203.	Tubular metal-framed stacking chairs from Italy and Taiwan.	(a) 8-10-84 (b) 8-31-84 (c) 9-24-84	Stern Liebeler Eckes Lodwick Rohr	—	—	1581	—	—	—	—	—

¹The Court of International Trade remanded this investigation for a new determination within 60 days from the date of entry of the order.

²With respect to imports of crystalline sorbitol.

³With respect to imports of liquid sorbitol.

⁴Commissioner Haggart did not participate in the vote in order to avoid any possibility or appearance of conflict of interest.

⁵With respect to imports from Taiwan.

⁶With respect to imports from the Republic of Korea.

⁷Commissioner Rohr did not participate in the vote because he was sworn in as a Commissioner after the hearing and had not participated in any aspect of the investigation.

⁸Commissioner Liebeler assumed her duties on Apr. 20, 1984, and was not a Commissioner during most of the investigative period.

⁹With respect to imports of light-walled, rectangular, welded carbon steel pipes and tubes.

¹⁰With respect to imports of heavy-walled, rectangular, welded carbon steel pipes and tubes.

¹¹Commissioner Liebeler did not participate in the vote because she was sworn in as a Commissioner after the hearing and was not a Commissioner during most of the investigative period.

¹²Vice Chairman Liebeler did not participate because of consulting work done by her husband through a Los Angeles law firm for a party potentially interested in the outcome of this investigation.

¹³With respect to brass pressure-regulating valves.

¹⁴With respect to imports from Argentina and South Africa.

¹⁵With respect to imports from Spain.

¹⁶Commissioner Stern did not participate in the vote in order to avoid any possibility or appearance of conflict of interest.

¹⁷With respect to imports of small-diameter, circular, welded carbon steel pipes and tubes.

¹⁸With respect to imports of light-walled, rectangular (including square), welded carbon steel pipes and tubes.

¹⁹Commissioner Eckes was in transit abroad and unable to vote.

Table 4

Countervailing duty investigations completed under sec. 701 of the Tariff Act of 1930, fiscal year 1984

Investigation No.	Article concerned	Preliminary investigation					Final investigation				
		(a) Request received (b) Conference (c) Report to Secretary of Commerce	Finding that "there is a reasonable indication [of injury]" (Commerce continues its investigation)	Finding that "there is no reasonable indication [of injury]" (Commerce terminates its investigation)	Not participating	USITC Publication No.	(a) Advice received from Commerce (b) Hearing (c) Report to Secretary of Commerce	Affirmative	Negative	Not participating	USITC Publication No.
701-TA-201	Forged under-carriage components from Italy.	—	—	—	—	—	(a) 8-30-83 (b) 11-22-83 (c) 12-21-83	Eckes Haggart Lodwick	Stern	—	1465
701-TA-202	Cotton shop towels from Pakistan.	—	—	—	—	—	(a) 10-27-83 (b) 1-17-84 (c) 2-23-84	Eckes Stern Haggart Lodwick	—	—	1490
701-TA-203	Pads for woodwind instrument keys from Italy.	(a) 11- 7-83 (b) 11-30-83 (c) 12-21-83	Eckes Stern Haggart Lodwick	—	—	1466	—	—	—	—	—
701-TA-204	Certain carbon steel products from Brazil.	(a) 10-10-83 (b) 12- 7-83	—	—	—	Terminated 11-29-83.	—	—	—	—	—
701-TA-205 through 701-TA-207.	Certain carbon steel products from Brazil.	(a) 10-10-83 (b) 12- 7-83 (c) 12-27-83	Eckes Stern Haggart Lodwick	—	—	1470	(a) 3- 5-84 (b) 4-27-84 (c) 6- 8-84	Eckes Stern Haggart Lodwick Rohr	—	Liebeler ¹	1538
701-TA-208	Iron bars from Brazil.	(a) 11-15-83 (b) 11-21-83 (c) 12-30-83	—	Eckes Stern Haggart Lodwick	—	1472	—	—	—	—	—
701-TA-209	Carbon steel wire rod from Spain.	(a) 11-23-83 (b) 12-14-83 (c) 1- 9-84	Eckes Stern Haggart Lodwick	—	—	1476	(a) 3-12-84 (b) 5- 7-84 (c) 6-22-84	Eckes Stern Lodwick Liebeler Rohr	—	Haggart ²	1544
701-TA-210 and 701-TA-211.	Certain table wine from France and Italy.	(a) 1-27-84 (b) 2- 1-84 (c) 2-17-84	—	Eckes Stern Lodwick	Haggart ²	1502	—	—	—	—	—
701-TA-212	Certain carbon steel products from Australia.	(a) 2-10-84 (b) 3- 7-84 (c) 3-26-84	Eckes Haggart Lodwick	Stern	—	1510	—	—	—	—	—
701-TA-213	Potassium chloride from Spain.	(a) 3-30-84 (b) 4-24-84 (c) 5-14-84	Eckes Haggart Lodwick Rohr	—	Stern ³ Liebeler ⁴	1529	—	—	—	—	—
701-TA-214	Lamb meat from New Zealand.	(a) 4-18-84 (b) 5-10-84 (c) 6- 4-84	Haggart Lodwick	Eckes Stern Rohr Liebeler	—	1534	—	—	—	—	—
701-TA-215 through 701-TA-217.	Oil country tubular goods from Brazil, the Republic of Korea, and Spain.	(a) 6-13-84 (b) 7- 6-84 (c) 7-30-84	Stern Liebeler Eckes Lodwick Rohr	—	—	1555	—	—	—	—	—

See footnotes at end of table.

Table 4—Continued

Countervailing duty investigations completed under sec. 701 of the Tariff Act of 1930, fiscal year 1984

Investigation No.	Article concerned	Preliminary investigation			Final investigation						
		(a) Request received (b) Conference (c) Report to Secretary of Commerce	Finding that "there is a reasonable indication [of injury]" (Commerce continues its investigation)	Finding that "there is no reasonable indication [of injury]" (Commerce terminates its investigation)	Not participating	USITC Publication No.	(a) Advice received from Commerce (b) Hearing (c) Report to Secretary of Commerce	Affirmative	Negative	Not participating	USITC Publication No.
701-TA-218 and 701-TA-219.	Certain carbon steel structural shapes and certain cold-rolled carbon steel sheet from the Republic of Korea.	(a) 6-18-84 (b) 7-10-84 (c) 8- 2-84	Stern ⁵ Liebeler Eckes Lodwick Rohr	Stern ⁶	—	1559	—	—	—	—	—
701-TA-220	Certain welded carbon steel pipes and tubes from Spain.	(a) 7-17-84 (b) 8- 8-84 (c) 8-31-84	Stern Liebeler ⁷ Eckes Lodwick Rohr	Liebeler ⁸	—	1569	—	—	—	—	—

¹Commissioner Liebeler assumed her duties on Apr. 20, 1984, and was not a Commissioner during most of the investigative period.

²Commissioner Haggart did not participate in the vote in order to avoid any possibility or appearance of conflict of interest.

³Commissioner Stern did not participate in the vote in order to avoid any possibility or appearance of conflict of interest.

⁴Commissioner Liebeler did not participate in the vote because she was sworn in as a Commissioner after the hearing and was not a Commissioner during most of the investigative period.

⁵With respect to imports of certain carbon steel structural shapes.

⁶With respect to imports of certain cold-rolled carbon steel sheet.

⁷With respect to imports of small-diameter, circular, welded carbon steel pipes and tubes.

⁸With respect to imports of light-walled, rectangular (including square), welded carbon steel pipes and tubes.

Table 5

Countervailing duty investigation completed under sec. 303 of the Tariff Act of 1930, fiscal year 1984

Investigation No.	Article concerned	Preliminary investigation			Final investigation						
		(a) Request received (b) Conference (c) Report to Secretary of Commerce	Finding that "there is a reasonable indication [of injury]" (Commerce continues its investigation)	Finding that "there is no reasonable indication [of injury]" (Commerce terminates its investigation)	Not participating	USITC Publication No.	(a) Advice received from Commerce (b) Hearing (c) Report to Secretary of Commerce	Affirmative	Negative	Not participating	USITC Publication No.
303-TA-15	Potassium chloride from Israel.	(a) 3-30-84 (b) 4-24-84 (c) 5-14-84	Eckes Haggart Lodwick Rohr	—	Stern ¹ Liebeler ²	1529	—	—	—	—	—

¹Commissioner Stern did not participate in the vote in order to avoid any possibility of appearance of conflict of interest.

²Commissioner Liebeler assumed her duties on Apr. 20, 1984, and was not a Commissioner during most of the investigative period.

Table 6

Countervailing duty investigation under sec. 303
of the Tariff Act of 1930 pending on Sept. 30, 1984

Investigation No.	Article concerned	Request received
303-TAA-15 (Final).	Potassium chloride from Israel	6-29-84

Table 7

Countervailing duty investigations completed under sec. 104
of the Trade Agreements Act of 1979, fiscal year 1984

Investigation No.	Article concerned	(a) Request received (b) Hearing (c) Report to Secretary of Commerce				USITC Publication No.
			Affirmative	Negative	Not participating	
104-TAA-19	Certain scissors and shears from Brazil.	(a) 7-11-83 (b) 10-20-83 (c) 11-15-83	—	Eckes Stern Haggart Lodwick	—	1456
104-TAA-20	Certain castor oil products from Brazil.	(a) 7-22-83 (b) 12- 8-83 (c) 1-27-84	Eckes Haggart Lodwick	Stern	—	1483
104-TAA-21	Cotton yarn from Brazil.	(a) 7-17-81 (b) 4- 6-84 (c) 5-17-84	Eckes ¹ Haggart ¹ Lodwick ¹ Rohr ¹	Eckes ² Stern Haggart ² Lodwick ² Rohr ²	Liebeler ³	1530
104-TAA-22	Bottled green olives from Spain.	(a) 4-23-82 (b) 4- 9-84 (c) 5-21-84	—	Eckes Stern Lodwick Rohr	Haggart ⁴ Liebeler ³	1531

¹100 percent cotton carded yarn from Brazil.

²All other cotton yarn.

³Commissioner Liebeler did not participate in the vote because she was sworn in as a Commissioner after the hearing and was not a Commissioner during most of the investigative period.

⁴Commissioner Haggart did not participate in the vote in order to avoid any possibility or appearance of conflict of interest.

Table 8**Antidumping and countervailing duty investigations
pending on Sept. 30, 1984**

Investigation No.	Article concerned	Request received
Preliminary: 701-TA-221	Certain cast-iron pipe fittings from Brazil	9-18-84
701-TA-222	Certain cast-iron pipe fittings from India	9-18-84
731-TA-204	Grand and upright pianos from the Republic of Korea	8-21-84
731-TA-205	Carbon steel wire rod from the German Democratic Republic	8-26-84
Final: 731-TA-149	Barium chloride from the People's Republic of China	4- 6-84
731-TA-155	Choline chloride from Canada	4-30-84
731-TA-157	Carbon steel wire rod from Argentina	5- 8-84
731-TA-160	Carbon steel wire rod from Spain	5- 8-84
731-TA-161	Titanium sponge from Japan	5-11-84
731-TA-162	Titanium sponge from the United Kingdom	5-11-84
731-TA-163	Cell-site transceivers and subassemblies thereof from Japan	6-12-84
731-TA-164	Stainless steel sheet from Spain	10-23-84
731-TA-165	Certain valves, nozzles, and connectors of brass from Italy for use in fire protection systems	7-10-84
731-TA-169	Carbon steel plate from Finland	7-25-84
731-TA-171	Carbon steel plate from Spain	7-25-84
731-TA-175	Cold-rolled carbon steel sheet from Argentina	7-25-84
731-TA-177	Cold-rolled carbon steel plate and sheet from Spain	7-25-84
731-TA-178	Galvanized carbon steel sheet from Australia	7-25-84
731-TA-180	Galvanized carbon steel sheet from Spain	7-25-84
731-TA-182	Carbon steel angles, shapes, and sections from Spain	7-25-84
731-TA-183	Large-diameter carbon steel welded pipes from Brazil	9- 5-84
731-TA-184	Potassium chloride from East Germany	9-12-84
731-TA-186	Potassium chloride from Spain	9-12-84
731-TA-187	Potassium chloride from the U.S.S.R.	9-12-84
701-TA-213	Potassium chloride from Spain	6-29-84
701-TA-215	Oil country tubular goods from Brazil	9-12-84
701-TA-216	Oil country tubular goods from the Republic of Korea	9-12-84
701-TA-217	Oil country tubular goods from Spain	9-12-84
104-TAA-23	Certain tomato products from Greece	3-16-84
751-TA-9	Drycleaning machinery from West Germany	5-18-84
751-TA-10	Frozen concentrated orange juice from Brazil	5-31-84

Table 9

“Review” investigation completed under sec. 751 of the Tariff Act of 1930, fiscal year 1984

Investigation No.	Article concerned	(a) Request received (b) Hearing (c) Report to Secretary of Commerce	Affirmative	Negative	Not participating	USITC Publication No.
751-TA-81 ¹	Acrylic sheet from Japan.	(a) 11-1-83	—	—	—	—

¹On June 27, 1984, the Commission, by notice, stated that the petition is moot and dismissed the petition without prejudice.

Table 10

“Review” investigations under sec. 751 of the Tariff Act of 1930 pending on Sept. 30, 1984

Investigation No.	Article concerned	Request received
751-TA-9	Drycleaning machinery from West Germany	5-18-84
751-TA-10	Frozen concentrated orange juice from Brazil	5-31-84

Table 11

Investigation completed under sec. 22 of the Agricultural Adjustment Act, fiscal year 1984

Investigation No.	Article concerned	Request received	Date investigation instituted	Public hearing	Finding and recommendations	Date report was		USITC Publication No.
						Submitted to President	Released by President	
22-46	Certain articles containing sugar.	6-29-83	7-7-83	10-25-83	Advise the President that imports of the blended sirups, flavored sirups, flavored sugars, and certain edible preparations, which are included in the emergency quotas established by Presidential Proclamation No. 5071, are practically certain to be imported into the United States under such conditions and in such quantities as to materially interfere with the price-support program for sugar cane and sugar beets undertaken by the Department of Agriculture.	12-16-83	—	1462

Table 12

Investigations of unfair trade practices completed under sec. 337 of the Tariff Act of 1930, fiscal year 1984

Article concerned	Complainant	Complaint filed	Date of publication of notice in <i>Federal Register</i> and No.	Public hearing	Finding and remedy of Commission	Date orders issued	USITC Publication No.
Certain multicellular plastic film.	Unipak (H.K.), Aberdeen, Hong Kong.	5- 5-83	6-15-83, 337-TA-54B.	—	No violation	6-19-84	—
Certain headboxes and papermaking machine forming sections for the continuous production of paper and components thereof.	Beloit Corp., Beloit, WI.	2-21-80	4- 8-80, 337-TA-82A.	2-24-81	Terminated ¹	8- 8-84	—
Certain plastic-capped decorative emblems.	D.L. Auld Co., Columbus, OH.	4-13-82; 5- 3-82 (amendment)	5-19-82, 337-TA-121.	—	Terminated	11-14-83	—
Certain grooved wooden handle kitchen utensils and gadgets.	Bonny Products Inc., Hewlett, NY.	7- 7-82	8-11-82, 337-TA-125.	—	Violation ²	4-13-84	—
Certain limited-charge cell culture micro-carriers.	Flow General, Inc., and Flow Laboratories, Inc., McLean, VA; Massachusetts Institute of Technology, Boston, MA.	7-19-82; 8- 3-82 (amendment)	8-25-82, 337-TA-129.	9-15-83	Terminated; no violation.	11-18-83	1486
Certain vertical milling machines and parts, attachments, and accessories thereto.	Textron Inc., Providence, RI.	10-14-82	11-17-82, 337-TA-133.	1- 9-84	Terminated; no violation.	3-22-84	1512
Certain heavy-duty staple gun tackers.	Arrow Fastener Co., Inc., Saddle Brook, NJ.	1- 7-83	3-24-83, 337-TA-137.	—	Violation ³	2-24-84	1506
Certain caulking guns.	Peter J. Chang, Columbia, MD.	1-26-83; 2- 9-83 (supplement)	2-24-83, 337-TA-139.	—	Violation ³	2-24-84	1507
Certain personal computers and components thereof.	Apple Computer, Inc., Cupertino, CA.	1-31-83	3- 9-83, 337-TA-140.	1-10-84	Violation ⁴	3- 9-84	1504
Certain direct current, brushless, axial flow fans.	Papst Mechatronic Corp., Middletown, RI.	3-11-83	4-13-83, 337-TA-144.	—	Terminated ⁵	12-12-83	—
Certain rotary wheel printers.	Qume Corp., San Jose, CA.	3-16-83	4-20-83, 337-TA-145.	—	Terminated ⁵	6- 8-84	—
Certain canape makers.	LK Manufacturing Corp., Greenvale, NY.	3-24-83; 4-18-83 and 4-20-83 (amendments)	4-27-83, 337-TA-146.	—	Violation ⁶	10-23-83	1436
Certain modular structural systems.	FOGA Systems Div. of R.C. Dudek & Co., Inc., Westlake Village, CA.	8- 8-83; 8-24-83 and 9- 1-83 (amendments)	9-15-83, 337-TA-164.	—	Terminated; no violation.	6- 4-84	—
Certain computerized jacquard pattern cutting systems.	Viable Systems, Inc., Needham, MA.	9- 7-83	10-13-83, 337-TA-166.	—	Terminated; no violation.	8-21-84	—

See footnotes at end of table.

Table 12—Continued

**Investigations of unfair trade practices completed under sec. 337
of the Tariff Act of 1930, fiscal year 1984**

Article concerned	Complainant	Complaint filed	Date of publication of notice in <i>Federal Register</i> and No.	Public hearing	Finding and remedy of Commission	Date orders issued	USITC Publication No.
Certain combination punch press and laser assemblies and components thereof.	Houdaille Industries, Inc., Strippit Div., Akron, NY.	9-16-83	10-26-83, 337-TA-168.	—	Terminated ⁵	6-20-84	—
Certain shearing machines.	Bendix Automation Co., Cleveland, OH.	10-21-83; 11- 8-83 and 11-16-83 (supplements)	11-25-83, 337-TA-172.	—	Terminated ⁵	9- 6-84	—
Certain valves.	Clow Corp., Oakbrook IL.	10-26-83; 11-14-83 and 11-18-83 (supplements)	11-30-83, 337-TA-173.	—	Terminated ⁵	8- 9-84	—
Certain metal and wire shelf products and accessories.	InterMetro Industries Corp., Wilkes Barre, PA.	11-10-83	12-16-83, 337-TA-175.	—	Terminated; with prejudice.	7- 2-84	—
Certain outboard motors and components thereof.	Outboard Marine Corp., Waukegan, IL	11-10-83; 11-28-83 (amendment)	12-16-83, 337-TA-176.	—	Terminated ⁵	5-18-84	—
Certain papermaking machine forming sections for the continuous production of paper and components thereof.	Beloit Corp., Beloit, WI.	4- 5-83	5-11-83, 337-TA-147.	—	Terminated; no violation.	3-19-84	—
Certain radar detectors and accompanying owner's manuals.	Cincinnati Microwave, Inc., Cincinnati, OH.	4-29-83	6- 2-83, 337-TA-149.	—	Terminated ⁵	1-11-84	—
Certain self-stripping electrical tap connectors.	Minnesota Mining & Manufacturing Co., St. Paul, MN.	5- 6-83; 5-19-83 (amendment)	6- 8-83, 337-TA-150.	—	Violation ⁷	5-24-84	—
Certain plastic food-storage containers.	Dart Industries, Inc., Northbrook, IL.	6- 9-83	7-13-83, 337-TA-152.	—	Violation ⁸	7-13-84	—
Certain micro-processors, related parts, and systems.	Zilog Inc., Campbell, CA.	6- 9-83	7-25-83, 337-TA-153.	—	Terminated ⁵	1-31-84	—
Certain dot matrix line printers and components thereof.	Printronic, Inc., Irving, CA.	6-16-83	7-27-83, 337-TA-154.	—	Terminated ⁹	3-14-84	—
Certain liquid crystal display watches with rocker switches.	Timex Corp., Waterbury, CT.	6-16-83	7-28-83, 337-TA-155.	—	Terminated ¹⁰	2-16-84	—
Certain minutiae-based automated fingerprint identification systems.	De La Rue Printrak Inc., Anaheim, CA.	6-22-83	8- 3-83, 337-TA-156.	—	Terminated with prejudice.	1-16-84	—
Certain office desk accessories and related products.	Eldon Industries, Inc., Hawthorne, CA.	7- 6-83; 7- 7-83 (supplement)	8-10-83, 337-TA-157.	—	Terminated	5- 3-84	—

See footnotes at end of table.

Table 12—Continued

Investigations of unfair trade practices completed under sec. 337 of the Tariff Act of 1930, fiscal year 1984

Article concerned	Complainant	Complaint filed	Date of publication of notice in <i>Federal Register</i> and No.	Public hearing	Finding and remedy of Commission	Date orders issued	USITC Publication No.
Certain plastic light screw anchors.	Mechanical Plastic Corp., Pleasantville, NY.	7-12-83	8-17-83, 337-TA-158.	—	Terminated ⁵	4- 6-84	—
Certain poultry cut up machines.	Foodcraft Equipment, Co., Inc., New Holland, PA.	7-14-83	8-24-83, 337-TA-159.	—	Terminated ¹¹	4-12-84	—
Certain composite diamond-coated textile machinery components.	Surface Technology, Inc., Princeton, NJ.	7-19-83	8-26-83, 337-TA-160.	—	Terminated; no violation.	7-23-84	—
Certain trolley wheel assemblies.	C.L. Frost & Sons, Inc., Grand Rapids, MI.	7-19-83	8-26-83, 337-TA-161.	—	Violation ¹²	8-29-84	—
Certain cardiac pacemakers and components thereof.	Medtronic, Inc., Minneapolis, MN.	8- 2-83	9-12-83, 337-TA-162.	—	Terminated with prejudice.	8-30-84	—
Certain nutating valve actuators and components thereof.	Morgan Industries, Inc., Seattle, WA.	8- 2-83; 8- 4-83, 8-16-83, and 8-22-83 (supplements)	9-14-83, 337-TA-163.	—	Terminated with prejudice.	4-11-84	—
Certain film web drive stretch apparatus and components thereof.	Lantech, Inc., Louisville, KY.	11-17-83; 12- 6-83 (amendment)	12-29-83, 337-TA-177.	—	Terminated ¹³	3-14-84	—

¹Consent order, Presidential review period has not expired as of Sept. 30, 1984.

²Cease and desist order and revocation of entry under bond, to remain in effect until July 1, 1985; President took no action; became final June 13, 1984.

³Exclusion order, President took no action; became final Apr. 25, 1984.

⁴Exclusion order, President took no action; became final May 9, 1984.

⁵Settlement agreement.

⁶Exclusion order, President took no action; became final Dec. 20, 1983.

⁷Exclusion order, President took no action; became final July 24, 1984.

⁸Exclusion order and cease and desist order; President took no action; became final Sept. 11, 1984.

⁹Consent order; President took no action; became final May 15, 1984.

¹⁰Consent order; President took no action; became final May 8, 1984.

¹¹Consent order; President took no action; became final June 12, 1984.

¹²Exclusion order; Presidential review period has not expired as of Sept. 30, 1984

¹³Consent order; President took no action; became final May 16, 1984.

Table 13

**Investigations of unfair trade practices under sec. 337
of the Tariff Act of 1930 pending on Sept. 30, 1984**

Article concerned	Complainant	Complaint filed	Date of publication of notice in <i>Federal Register</i> and No.	Public hearing
Certain large video matrix display systems and components thereof.	Stewart-Warner Corp., Chicago, IL.	10-26-79	12-19-79, 337-TA-75. ¹	5-8-81
Certain amorphous metal alloys and amorphous metal articles.	Allied Corp., Morristown, NJ.	3-11-83	4-12-83, 337-TA-143.	—
Certain processes for the manufacture of skinless sausage casing and the resulting product.	Teepak Inc., Chicago, IL; Bufpak Corp., New York, NY.	4-25-83	5-25-83, 337-TA-148. ²	—
Certain apparatus for flow injection analysis and components thereof.	U.S. International Trade Commission.	6-15-83	6-22-83, 337-TA-151. ³	—
Certain alkaline batteries	Duracell Inc., Bethel, CT.	8-16-83	9-21-83, 337-TA-165.	—
Certain single-handle faucets	Masco Corp. of Indiana, Indianapolis, IN.	9-16-83; 10- 7-83 (supplement)	10-24-83, 337-TA-167.	—
Certain processes for the manufacture of skinless sausage casings and resulting product.	Union Carbide Corp., Danbury, CT.	9-20-83; 10-11-83 (amendment)	10-26-83, 337-TA-169. ²	—
Certain bag closure clips	Chip Clip Corp., Dearborn, MI.	10- 5-83	11- 9-83, 337-TA-170.	—
Certain glass-tempering systems	Glasstech, Inc., Perrysburg, OH.	10-11-83,	11-16-83 337-TA-171.	—
Certain woodworking machines	Delta International Machinery Corp., Pittsburgh, PA.	11-10-83; 11-21-83 (supplement)	12-15-83, 337-TA-174. ⁴	—
Certain vinyl-covered foam blocks	The Dolly Toy Co., Tipp City, OH.	11-23-83; 12- 8-83 (supplement)	12-28-83, 337-TA-178.	—
Certain spherical roller bearings and components thereof and tools and equipment for the manufacture thereof.	SKF Industries, Inc., King of Prussia, PA.	12- 5-83	1-11-84, 337-TA-179.	—
Certain X-ray image intensifier tubes.	Varian Associates, Inc., Palo Alto, CA.	12-21-83	2- 1-84, 337-TA-180.	—
Certain meat-deboning machines	Lever Brothers, Co., New York, NY; Protecon, B.V., Holland Protecon, Inc., Kenosha, WI.	1- 3-84; 1-31-84 and 2- 1-84 (supplements)	2-15-84, 337-TA-181.	—
Certain fluidized supporting apparatus.	Support Systems Intl. Inc., Charleston, SC.	1- 4-84; 1- 9-84 and 1-25-84 (supplements)	2-15-84, 337-TA-182. ⁵	—
Certain indomethacin	Merck & Co., Inc., Rahway, NJ.	1-17-84	2-23-84, 337-TA-183.	—
Certain foam earplugs	Cabot Corp., Boston, MA.	1-19-84; 2- 6-84 and 2-10-84 (supplements)	2-29-84, 337-TA-184.	—

See footnotes at end of table.

Table 13—Continued

**Investigations of unfair trade practices under sec. 337
of the Tariff Act of 1930 pending on Sept. 30, 1984**

Article concerned	Complainant	Complaint filed	Date of publication of notice in <i>Federal Register</i> and No.	Public hearing
Certain rotary wheel printing systems.	Qume Corp., San Jose, CA.	1-27 84	3- 7-84, 337-TA-185.	—
Certain tennis rackets	Prince Manufacturing Inc., Princeton, NJ.	1-26-84	3- 7-84, 337-TA-186.	—
Certain glass construction blocks.	Pittsburgh Corning Corp., Pittsburgh, PA.	2- 2-84; 2-21-84 and 2-23-84 (supplements)	3-14-84, 337-TA-187.	—
Certain fluidized supporting apparatus and components thereof.	UHI Corp., Los Angeles, CA.	2-23-84	3-28-84, 337-TA-188. ⁵	—
Certain optical waveguide fibers.	Corning Glass Works, Corning, NY.	3- 7-84; 3-27-84 (supplement)	4-18-84, 337-TA-189.	—
Certain softballs and polyurethane cores therefor.	Lannom Manufacturing Co., Inc., Tullahoma, TN.	4- 3-84	5-11-84, 337-TA-190.	—
Certain stretch wrapping apparatus and components thereof.	Lantech, Inc., Louisville, KY.	4-11-84	5-17-84, 337-TA-191.	—
Certain spring-balanced arm lamp heads.	Luxo Lamp Corp., Port Chester, NY.	4-12-84	5-23-84, 337-TA-192.	—
Certain rowing machines and components thereof.	Precor, Inc., Redmond, WA.	4-16-84	5-23-84, 337-TA-193.	—
Certain aramid fiber	E. I. du Pont de Nemours & Co., Wilmington, DE.	4-18-84	5-23-84, 337-TA-194.	—
Certain cloisonne jewelry	Laurel Burch, Inc., San Francisco, CA.	4-26-84	6- 6-84, 337-TA-195.	—
Certain apparatus for installing electrical lines and components therefor.	Scoggins Manufacturing Inc., Graham, NC.	5-14-84	6-20-84, 337-TA-196.	—
Certain compound-action metal-cutting snips and components therefor.	Cooper Industries, Inc., Houston, TX	6- 7-84	7-18-84, 337-TA-197.	—
Certain portable electronic calculators.	Texas Instruments, Inc., Dallas, TX.	6- 8-84; 6-28-84 and 7- 2-84 (supplements)	7-18-84, 337-TA-198.	—
Certain anodes for cathodic protection and components thereof.	The Duriron Co., Inc., Dayton, OH.	6-11-84; 6-22-84 (supplement)	7-25-84, 337-TA-199.	—
Certain ink jet printing systems and components thereof.	A. B. Dick Co., Chicago, IL.	6-12-84; 6-28-84 (supplement)	7-25-84, 337-TA-200.	—
Certain products with Gremlin character depictions.	Warner Bros. Inc., New York, NY.	7-25-84; 8-10-84 (amendment); 8-17-84 (supplement)	8-30-84, 337-TA-201.	—

See footnotes at end of table.

Table 13—Continued

**Investigations of unfair trade practices under sec. 337
of the Tariff Act of 1930 pending on Sept. 30, 1984**

Article concerned	Complainant	Complaint filed	Date of publication of notice in <i>Federal Register</i> and No.	Public hearing
Certain telephone base housings and related packaging and printed materials.	GTE Communication Systems Corp., Phoenix, AZ.	7-26-84; 8-14-84 (supplement)	9- 6-84, 337-TA-202.	—
Certain floppy disk drives and components thereof.	Tandon Corp., Chatsworth, CA.	8- 1-84; 8-13-84 (supplement)	9- 6-84, 337-TA-203.	—
Certain pull-type golf carts and wheels therefor.	Ajay Enterprises Corp., Delavan, WI; Spherex, Inc., Seabrook, NH.	8- 8-84	9-19-84, 337-TA-204.	—
Certain dialyzers using telescoping connectors for fluid lines.	Baxter Travenol Laboratories, Inc., Deerfield, IL.	8-29-84; 9-14-84 (amendment)	337-TA-205	—
Certain surgical implants for fixation of bone fragments.	Synthes Ltd. (U.S.A.), Wayne, PA.	9- 6-84	—	—
Certain automotive transmission shifters.	Grand Haven Stamped Products, Division of JSJ Corp., Grand Haven, MI.	9-20-84	—	—

¹Commission found no infringement of claim 12 of U.S. Letters Patent 3,495,762 and suspended the remainder of the investigation until the Court of Appeals for the Federal Circuit issues an opinion regarding the validity of U.S. Letters Patent 3,941,926, in a case currently pending before that court.

²Commission consolidated with 337-TA-169 on Nov. 22, 1983.

³Commission on May 7, 1984, suspended investigation until completion of the reexamination proceeding pending before U.S. Patent and Trademark Office.

⁴Rockwell International Corp. was the original complainant. On Apr. 12, 1984, the portion of Rockwell's Power Tool Division

that includes manufacture and sale of woodworking machines in issue was sold by Rockwell to Delta International Machinery Corp. Commission accepted substitution May 31, 1984.

⁵Investigation consolidated with 337-TA-188 on Apr. 13, 1984. Commission on Aug. 31, 1984, suspended the investigations pursuant to 337(b)(1).

Table 14

General investigations of trade and tariff matters completed under sec. 332 of the Tariff Act of 1930, fiscal year 1984

Investigation No.	Subject	Origin	USITC Publication	
			No.	Date
332-111	Semiannual and annual surveys on nonelectric cooking ware of steel.	Request from the President— Presidential Proclamation No. 4713.	—	—
332-116	Effect of the enlargement of the European Community on U.S. trade.	Instituted by the U.S. International Trade Commission on its own motion.	—	—
332-152	Monthly reports providing information on the U.S. automobile industry.	Request from the Subcommittee on Trade, Committee on Ways and Means, U.S. House of Representatives.	1438 1452 1460 1478 1489	October 1983 November 1983 December 1983 January 1984 February 1984
332-154	U.S. trade-related employment.	Instituted by the U.S. International Trade Commission on its own motion.	1445	October 1983
332-155	The competitive position of U.S. producers of robotics in domestic and world markets.	Instituted by the U.S. International Trade Commission on its own motion.	1475	January 1984
332-156	Competitive assessment of the U.S. ceramic floor and wall tile industry.	Instituted by the U.S. International Trade Commission on its own motion.	1442	October 1983
332-157	U.S. embargoes on agricultural exports: implications for the U.S. agricultural industry and U.S. exports.	Instituted by the U.S. International Trade Commission on its own motion.	1461	December 1983
332-158	The effects of foreign product counterfeiting on U.S. industry.	Instituted by the U.S. International Trade Commission on its own motion.	1479	January 1984
332-160	A competitive assessment of the U.S. video game industry.	Instituted by the U.S. International Trade Commission on its own motion.	1501	March 1984
332-161	The possible effects of changing world crude petroleum prices.	Instituted by the U.S. International Trade Commission on its own motion.	1494	February 1984
332-163	Trends in international trade in nonpowered handtools.	Request from the Subcommittee on Trade, Committee on Ways and Means, U.S. House of Representatives.	1485	February 1984
332-165	The implications of foreign-trade zones for U.S. industries and for competitive conditions between U.S. and foreign firms.	Request from the Subcommittee on Trade, Committee on Ways and Means, U.S. House of Representatives.	1496	February 1984
TA-503(a)-11 and 332-166.	President's list of articles which may be designated or modified as eligible articles for purposes of the U.S. Generalized System of Preferences.	Request from the United States Trade Representative.	1 1256	November 1983 May 1984

See footnote at end of table.

Table 14—Continued

General investigations of trade and tariff matters completed under sec. 332 of the Tariff Act of 1930, fiscal year 1984

Investigation	Subject	Origin	USITC Publication	
			No.	Date
332-169	Competitive conditions relating to the importation of industrial molds into the United States from Canada.	Request from the Chairman of the Subcommittee on Trade, Committee on Ways and Means, U.S. House of Representatives.	1522	April 1984
332-170	A study on a competitive assessment of the U.S. wood and upholstered household furniture industry.	Request from the Subcommittee on Trade, Committee on Ways and Means, U.S. House of Representatives.	1543	June 1984
332-171	Probable economic effect on U.S. producers of the expansion of the duty-free coverage of the agreement on trade in civil aircraft.	Request from the United States Trade Representative.	¹	February 1984
332-172	Changes in the U.S. telecommunications industry and the impact on U.S. telecommunications trade.	Request from the Committee on Finance, U.S. Senate.	1542	June 1984
332-176	Competitive assessment of the U.S. foundry industry.	Request from the United States Trade Representative.	1582	August 1984
332-179	The impact of tariff and nontariff barriers on the U.S. sheet vinyl flooring industry.	Instituted by the U.S. International Trade Commission on its own motion.	1562	August 1984
332-180	Probable economic effect of providing duty-free treatment for imports from Israel.	Request from the United States Trade Representative.	¹	May 1984

¹Confidential report.

Table 15

**General investigations of trade and tariff matters under
sec. 332 of the Tariff Act of 1930 pending on Sept. 30, 1984**

Investigation No.	Subject	Origin	USITC Publication	
			No.	Date
332-73	Formulation of an international commodity code.	Sec. 608(c)(1) of the Trade Act of 1974	—	—
332-84	Quarterly statistical reports providing certain information on canned and frozen mushrooms.	Request from the President	1498 1537 1573	February 1984 May 1984 August 1984
332-97	Report on consumption of corn brooms.	Public Law 89-241 and Executive Order 11377.	1518	April 1984
332-135	Synthetic organic chemical reports.	Instituted by the U.S. International Trade Commission on its own motion.	1469 1548	January 1984 July 1984
332-153	Monthly reports on selected steel industry data.	Request from the Subcommittee on Trade, Committee on Ways and Means, U.S. House of Representatives.	1439 1453 1464 1482 1491 1509 1516 1528 1546 1554 1567 1578	October 1983 November 1983 December 1983 January 1984 February 1984 March 1984 April 1984 May 1984 June 1984 July 1984 August 1984 September 1984
332-162	Foreign industrial targeting and its effects on U.S. industries.	Request from the Subcommittee on Trade, House Committee on Ways and Means, U.S. House of Representatives.	1437 1517	October 1983 April 1984
332-164	Quarterly and annual reports providing information on heavyweight motorcycles.	Presidential Proclamation No. 5050	1455 1492 1493 1533 1570	November 1983 February 1984 February 1984 May 1984 August 1984
332-167	Quarterly survey on certain stainless steel and alloy tool steel.	Presidential Proclamation No. 5074	1432 1449 1487 1508 1523 1560	October 1983 November 1983 February 1984 February 1984 March 1984 March 1984 May 1984 August 1984
332-168	China's economic development strategies and their effects on U.S. trade.	Instituted by the U.S. International Trade Commission on its own motion.	—	—
332-173	Conditions of competition affecting the Northeastern U.S. groundfish and scallop industries in selected markets.	Request from the United States Trade Representative.	—	—
332-174	International developments in biotechnology and their possible impact on certain sectors of the U.S. chemical industry.	Instituted by the U.S. International Trade Commission on its own motion.	—	—
332-175	Rum: Annual report on selected economic indicators.	Request from the Senate Committee on Finance.	—	—

See footnote at end of table.

Table 15—Continued

**General investigations of trade and tariff matters under
sec. 332 of the Tariff Act of 1930 pending on Sept. 30, 1984**

Investigation No.	Subject	Origin	USITC Publication	
			No.	Date
332-177	Monthly reports providing information on the U.S. automobile industry.	Request from the Subcommittee on Trade, Committee on Ways and Means, U.S. House of Representatives.	1503 1515 1527 1541 1551 1564 1576	March 1984 April 1984 May 1984 June 1984 July 1984 August 1984 September 1984
332-178	A study of U.S. imports of goods manufactured by convict, forced, or indentured labor.	Request from the Senate Committee on Finance.	—	—
332-181	Conditions of competition between certain domestic and imported fabricated structural steel products.	Instituted by the U.S. International Trade Commission on its own motion.	—	—
332-182	The position and competitiveness of the United States in world coal trade.	Instituted by the U.S. International Trade Commission on its own motion.	—	—
332-183	The shift from U.S. production of commodity petrochemicals to value-added chemical products and the possible impact on U.S. trade.	Instituted by the U.S. International Trade Commission on its own motion.	—	—
332-184	Emerging textile-exporting countries.	Instituted by the U.S. International Trade Commission on its own motion.	—	—
332-185	Assessment of the effects of barter and countertrade transactions on U.S. industries.	Instituted by the U.S. International Trade Commission on its own motion.	—	—
332-186	Conditions of competition between the U.S. and Canadian live swine and pork industries.	Request from the Senate Committee on Finance.	—	—
332-187 and TA-503(a)-12.	President's list of articles which may be designated or modified as eligible articles for purposes of the U.S. Generalized System of Preferences.	Request from the President	—	—
332-188	The internationalization of the automobile industry and its effects on the U.S. automobile industry.	Initiated by the U.S. International Trade Commission on its own motion.	—	—
332-189	Study of the multifiber arrangement.	Initiated by the U.S. International Trade Commission on its own motion.	—	—
332-190	Headwear of cotton and of manmade fibers.	Request from the United States Trade Representative.	—	—
332-191	Nonrubber footwear quarterly statistical reports.	Request from the Senate Committee on Finance.	—	—
332-192	The impact of rules of origin on U.S. imports and exports.	Request from the President	—	—

See footnote at end of table.

Table 15—Continued

General investigations of trade and tariff matters under
sec. 332 of the Tariff Act of 1930 pending on Sept. 30, 1984

Investigation No.	Subject	Origin	USITC Publication	
			No.	Date
332-193	Conditions of competition between the U.S. and major foreign filbert industries.	Request from the Senate Committee on Finance.	—	—
332-194	World trade flows in major agricultural products.	Request from the Senate Committee on Finance.	—	—

¹ Confidential report.

Table 16

Preliminary investigation pending under sec. 603
of the Trade Act of 1974, fiscal year 1984

Investigation No.	Article concerned	Date and basis for initiation	Hearing	Commission finding	USITC Publication No.
603-TA-9	Certain hydrogenerators from Japan.	4-11-84	—	—	—

Table 17

Investigations having no legally fixed dates for completion

Investigation title	Date received or instituted	Comment
Butter from Australia	5-17-82	Staff work in progress
Unwrought zinc from Spain	4-23-82	Terminated 10-5-84
Ferroalloys from Spain	4-23-82	Staff work in progress
Vitamin K from Spain	6-17-82	Staff work in progress
Amoxicillin trihydrate and its salts from Spain	9-13-84	Staff work in progress
Certain hydrogenerators from Japan	4-11-84	Staff work in progress

Appendix C

Reports Submitted to Congress on Proposed Legislation

Reports Submitted to the Senate on Proposed Legislation

1. S. 1431 (Mr. Durenberger)—To suspend for a 2-year period the duty on the chemical commonly known as Flecainide acetate. October 18, 1983.
2. S. 1636 (Ms. Hawkins)—To amend the Tariff Schedules of the United States to establish equal and equitable classification and duty rates for certain imported citrus products. October 5, 1983.
3. S. 1642 (Mr. Matsunaga)—Relating to the tariff treatment of certain telescopes not designed for use with infrared light. October 26, 1983.
4. S. 1743 (Mr. Pell)—To amend the Tariff Schedules of the United States to suspend for a 3-year period the duty on certain benzenoid chemicals (NA-125 and NA-125-chloride). October 3, 1983.
5. S. 1759 (Mr. Symms)—To extend for 3 years the suspension of duty on 4-chloro-3-methylphenol. October 4, 1983.
6. S. 1771 (Mr. Moynihan)—To extend temporary suspension of duties on certain clock radios until September 30, 1987. October 5, 1984.
7. S. 1808 (Mr. Mattingly)—To amend the Tariff Act of 1930 regarding the country-of-origin marking requirements for certain imported pipe, pipe fittings, and compressed-gas cylinders. October 25, 1983.
8. S. 1836 (Mr. D'Amato)—To provide equitable treatment for certain fresh vegetables produced in the United States. December 12, 1983.
9. S. 1845 (Mr. Chafee)—To amend the Tariff Schedules of the United States to extend duty-free treatment to the reimportation of certain articles originally imported duty free. December 7, 1983.
10. S. 1853 (Mr. Tower)—To amend the Tariff Act of 1930 to exempt from duties equipments and repairs to certain vessels, and for other purposes. December 16, 1983.
11. S. 1886 (Mr. Grassley)—To amend the Tariff Schedules of the United States to suspend for a 3-year period the duty on certain chemical intermediates. December 16, 1983.
12. S. 1954 (Mr. Johnson)—To apply duty-free treatment with respect to articles exported for purposes of rendering certain geophysical or contracting services abroad and returned. January 20, 1984.
13. S. 1972 (Mr. Roth)—To amend the Tariff Act of 1930 to allow drawbacks if imported bulk articles are exchanged for domestic articles that are used in the manufacture or production of exports. December 21, 1983.
14. S. 1977 (Mr. Percy)—To amend the Foreign Trade Zones Act to exempt until June 30, 1986, bicycle component parts which are not reexported from the exemption from the customs laws otherwise available to merchandise in foreign-trade zones. December 21, 1983.
15. S. 1986 (Mr. DeConcini)—To provide for the duty-free entry of articles required for the installation and operation of a telescope in Arizona. January 24, 1984.

16. S. 2003 (Mr. Domenici)—To amend the Tariff Schedules of the United States to impose duties on subsidized hydraulic cement, cement clinker, and concrete block and brick. February 15, 1984.
17. S. 2010 (Mr. Tsongas)—To amend subpart E, part 3, schedule 6, of the Tariff Schedules of the United States. March 14, 1984.
18. S. 2019 (Mr. Grassley)—To permit until December 31, 1986, the duty-free entry of magnetron tubes used in microwave cooking appliances. January 3, 1984.
19. S. 2022 (Mr. Moynihan)—To suspend temporarily the duty on diphenyl guanidine and di-ortho-tolyl guanidine. September 26, 1984.
20. S. 2054 (Mr. Symms)—To suspend for a 3-year period the duty on hydrazone, 3-(4-methylpiperazinylimino-methyl)rifamycin SV. December 16, 1983.
21. S. 2055 (Mr. Symms)—To suspend for a 3-year period the duty on 5H-Dibenz[b,f]azepine-5-propanamine, 10, 11-dihydro-N-methyl-monohydrochloride. December 13, 1983.
22. S. 2056 (Mr. Symms)—To suspend for a 3-year period the duty on 3-[(hydroxydiphenylacetyl)oxy]-1,1-dimethylpiperidinium bromide. December 16, 1983.
23. S. 2092 (Mr. Bentsen)—To continue until the close of June 30, 1989, the existing suspension of duties on certain forms of zinc. February 16, 1984.
24. S. 2156 (Mr. Warner)—To repeal the existing suspension of duty on carob flour. February 21, 1984.
25. S. 2172 (Mr. Wallop)—To suspend for a 3-year period the duty on Clo-miphene citrate. January 16, 1984.
26. S. 2182 (Mr. Wilson)—To harmonize, reduce, and eliminate barriers to trade in wine on a basis that ensures substantially equivalent competitive opportunities for all wines moving in international trade. February 22, 1984.
27. S. 2194 (Mr. Mitchell)—To amend the general headnotes of the Tariff Schedules of the United States regarding products of the insular possessions. February 15, 1984.
28. S. 2197 (Mr. Wallop)—To suspend for a 3-year period the duty on Terfenadine. February 14, 1984.
29. S. 2198 (Mr. Wallop)—To suspend for a 3-year period the duty on Dicyclomine hydrochloride. February 16, 1984.
30. S. 2200 (Mr. Thurmond)—To temporarily suspend the duty on tetraaminobiphenyl until 4 years after date of enactment. April 4, 1984.
31. S. 2288 (Mr. Levin)—To extend duty-free treatment to imports of chipper knife steel. July 3, 1984.
32. S. 2293 (Mr. Levin)—To provide for the duty-free entry of a ring of eight bells for the use of Kalamazoo College, Kalamazoo, MI. May 15, 1984.
33. S. 2317 (Mr. Heinz)—To suspend for 3 years the duty of crude 8+5-hydroxyquinolines. June 2, 1984.
34. S. 2332 (Mr. Bentsen)—To suspend for a 3-year period the duty on lactulose. May 2, 1984.
35. S. 2333 (Mr. Bentsen)—To suspend for a 3-year period the duty on iron-dextran complex. May 2, 1984.
36. S. 2334 (Mr. Bentsen)—To suspend for a 3-year period the duty on nicotine resin complex. May 22, 1984.

37. S. 2340 (Mr. DeConcini)—To increase the duty on imported copper by an amount that offsets the cost incurred by copper producers in the United States in meeting domestic environmental requirements. May 5, 1984.
38. S. 2426 (Mr. Heinz)—To provide for the temporary suspensions of the duty on mixtures of 5-chloro-2-methyl-4-isothiazolin-3-one, 2-methyl-4-isothiazoline-3-one, magnesium chloride and magnesium nitrate. May 10, 1984.
39. S. 2427 (Mr. Heinz)—To provide for temporary suspension of the duty on mixtures of potassium 1-(p-chlorophenyl)-1,4-dihydro-6-methyl-4-oxo-pyridazine-3-carboxylate ("fenridazon-potassium") and formulation adjuvants. June 6, 1984.
40. S. 2428 (Mr. Exon)—Relating to classification of imported steel tubes used in lampposts. June 2, 1984.
41. S. 2429 (Mr. Packwood)—To amend the Tariff Schedules of the United States to increase the duty on certain shelled filberts. June 5, 1984.
42. S. 2439 (Mr. Randolph)—To suspend the duty on certain surface-active agents until the close of June 30, 1986. June 5, 1984.
43. S. 2440 (Mr. Randolph)—To suspend the duty on certain benzenoid chemicals until the close of June 30, 1986. June 11, 1984.
44. S. 2441 (Mr. Randolph)—To suspend the duty on certain nitrogenous chemical compounds until the close of June 30, 1986. June 22, 1984.
45. S. 2474 (Mr. Heinz)—To amend the Tariff Schedules of the United States with respect to the tariff treatment accorded to film, strips, and sheets of acrylic plastic materials. June 15, 1984.
46. S. 2479 (Mr. Bentsen)—To amend the Tariff Schedules of the United States to clarify the classification of any naphtha described as both a petroleum product and a benzenoid chemical. May 30, 1984.
47. S. 2493 (Mr. Moynihan)—To extend for 4 years the temporary suspension of duty on tartaric acid and certain tartaric chemicals. May 10, 1984.
48. S. 2542 (Mr. Heinz)—To suspend until July 1, 1987, the duty on lace-braiding machines and parts thereof. June 22, 1984.
49. S. 2596 (Mr. Matsunaga)—To extend duty-free treatment to scrolls or tablets imported for use in religious observances. June 22, 1984.
50. S. 2613 (Mr. Heinz)—To suspend the duties on circular knitting machines designed for sweater or garment length knitting until the close of December 31, 1989. July 13, 1984.
51. S. 2642 (Mr. Goldwater)—To suspend until July 1, 1989, the duty on yttrium-bearing ores, materials, and compounds containing by weight more than 19 percent but less than 85 percent yttrium oxide equivalent. August 30, 1984.
52. S. 2712 (Mr. Johnston)—To return the ad valorem and specific duties on necktie imports to the levels in effect as of January 1, 1981, for a period of 5 years. September 4, 1984.
53. S. 2739 (Mr. Dodd)—To extend for 2 additional years the suspension of duty on uncompounded allyl resins. July 25, 1984.
54. S. 2787 (Mr. Heinz)—To suspend for a 3-year period the duty on o-benzyl-p-Chlorophenol. August 28, 1984.

55. S. 2827 (Mr. Moynihan)—Relating to the tariff classification of certain silicone resins and materials. August 31, 1984.
56. S. 2839 (Mr. Moynihan)—To amend the Tariff Schedules of the United States regarding the classification of certain articles of wearing apparel. September 5, 1984.
57. S. 2863 (Mr. Grassley)—To suspend the duty on acetylsulfaguanidine until the close of December 31, 1986. September 14, 1984.
58. S. 2865 (Mr. Dole)—Authorizing the President to proclaim modifications in the rates of duty for certain articles in trade in civil aircraft. September 17, 1984.
59. S. 2877 (Mr. Bradley)—Relating to the tariff treatment of certain canned mushrooms. September 27, 1984.
60. S. 2896 (Mr. Boschwitz)—Providing for a reduction in the duty on certain fresh asparagus. September 17, 1984.
61. S. 2769 (Finance Committee)—To promote economic revitalization and facilitate expansion of economic opportunities in the Caribbean Basin region. October 12, 1983.
62. S. 3398 (Finance Committee)—To change the tariff treatment with respect to certain articles, and for other purposes.
- Sec. 113—Classification of certain gloves. October 3, 1983.
- Sec. 114—Uniform tariff treatment of pet toys. October 14, 1983.
- Sec. 121—Crude feathers and down. October 13, 1983.
- Sec. 122—Canned corned beef. October 14, 1983.
- Sec. 126—4,4-Bis(alpha, alpha-dimethylbenzyl) diphenylamine. October 12, 1983.
- Sec. 127—Flecainide acetate. October 14, 1983.

- Sec. 204—Unlawful importation or exportation of certain vehicles; inspections. October 4, 1984.
- Sec. 211(a)—Foreign-trade zone. October 3, 1983.
- Sec. 211(b)—Section 3 of the act of June 18, 1984 (commonly known as the Foreign Trade Zones Act (19 U.S.C. 81c)) is amended. February 1, 1984.

Reports Submitted to the House on Proposed Legislation

1. H.R. 717 (Mr. Wright)—To provide that certain property held in foreign-trade zones shall be exempt from State and local ad valorem taxation. January 30, 1984.
2. H.R. 3158 (Mr. Gibbons)—To implement the Customs Convention on Containers, 1972. November 14, 1983.
3. H.R. 3159 (Mr. Gibbons)—To require that customs duties determined to be due upon a liquidation or reliquidation are due upon that date, and for other purposes. November 4, 1983.
4. H.R. 3174 (Mr. Matsui)—Relating to the tariff treatment of certain telescopes not designed for use with infrared light. October 26, 1983.
5. H.R. 3587 (Mr. Ireland)—To amend the Tariff Schedules of the United States to establish equal and equitable classification and duty rates for certain imported citrus products. October 5, 1983.
6. H.R. 3727 (Mr. Downey)—To eliminate import quotas on sugar. December 12, 1983.

7. **H.R. 3731** (Mr. Vander Jagt)—To extend temporary suspension of duties on certain clock radios until September 30, 1987. October 5, 1984.
8. **H.R. 3740** (Mr. Albosta)—To suspend for a 3-year period the duty on 3-[(Hydroxydiphenylacetyl)oxy]-1,1-dimethylpiperidinium bromide. December 13, 1983.
9. **H.R. 3741** (Mr. Albosta)—To suspend for a 3-year period the duty on 5H-Dibenz[b,f]azepine-5-propanamine, 10, 11-dihydro-N-methyl-, monohydrochloride. December 16, 1983.
10. **H.R. 3742** (Mr. Albosta)—To suspend for a 3-year period the duty on hydrazone, 3-(4-methylpiperazinyliminomethyl)rifamycin SV. December 16, 1983.
11. **H.R. 3785** (Mr. Brooks)—To suspend for 1 year the duty on catalytic naphtha. December 16, 1983.
12. **H.R. 3795** (Mr. Coelho)—To harmonize, reduce, and eliminate barriers to trade in wine on a basis that ensures substantially equivalent competitive opportunities for all wine moving in international trade. January 3, 1984.
13. **H.R. 3983** (Mr. Heftel)—Regarding the operation of certain duty-free sales enterprises. June 11, 1984.
14. **H.R. 4035** (Mr. Jacobs)—To suspend temporarily the duty on a certain chemical intermediate. December 16, 1983.
15. **H.R. 4178** (Mr. McKinney)—To amend the Tariff Act of 1930 to increase from \$250 to \$1,500 the value of goods eligible for informal entry, and for other purposes. June 11, 1984.
16. **H.R. 4218** (Mr. Britt)—To extend duty-free treatment to Meta-toluic acid (MTA). January 31, 1984.
17. **H.R. 4223** (Mr. Moore)—To suspend for a 3-year period the duty on 4-O-beta-D-galactopyranosyl-D-fructose. February 22, 1984.
18. **H.R. 4224** (Mr. Moore)—To suspend for a 3-year period the duty on nicotine resin complex. February 24, 1984.
19. **H.R. 4225** (Mr. Moore)—To suspend for a 3-year period the duty on an iron-dextran complex. May 2, 1984.
20. **H.R. 4232** (Mr. Brooks)—To amend the Tariff Schedules of the United States to clarify the classification of any naphtha described as both a petroleum product and a benzenoid chemical. January 24, 1984.
21. **H.R. 4255** (Mr. Frenzel)—Providing for a reduction in the duty on certain fresh asparagus. March 16, 1984.
22. **H.R. 4329** (Mr. Crane)—To extend until July 1, 1987, the existing suspension of duty on 4-chloro-3-methylphenol. May 2, 1984.
23. **H.R. 4339** (Mr. Guarini)—To amend the Tariff Schedules of the United States regarding the classification of certain articles of wearing apparel. April 17, 1984.
24. **H.R. 4353** (Mr. Heftel)—Relating to the tariff classification of salted and dried plums, and for other purposes. April 16, 1984.
25. **H.R. 4443** (Mr. Jones)—To continue until the close of June 30, 1989, the existing suspension of duties on certain forms of zinc. May 3, 1984.
26. **H.R. 4482** (Mr. Archer)—To amend the Tariff Schedules of the United States with respect to the classification of certain diamond articles. May 25, 1984.

27. **H.R. 4513** (Mr. Green)—To extend for 4 years the temporary suspension of duty on tartaric acid and certain tartaric chemicals. May 10, 1984.
28. **H.R. 4560** (Mr. Shannon)—To amend the general headnotes of the Tariff Schedules of the United States regarding products of the insular possessions. July 1, 1984.
29. **H.R. 4647** (Mr. Frenzel)—To apply a reduced rate of duty to certain dried egg yolk processed from eggs produced in the United States and exported to Canada for use in the manufacture of lysozyme. April 6, 1984.
30. **H.R. 4695** (Mr. Edwards)—To amend the Tariff Schedules of the United States to impose a duty on tubeless tire valves. May 1, 1984.
31. **H.R. 4765** (Mr. Albosta)—To extend duty-free treatment to imports of chipper knife steel. July 3, 1984.
32. **H.R. 4790** (Mr. Clinger)—To suspend for 3 years the duty on crude 8+5-hydroxyquinolines. July 2, 1984.
33. **H.R. 4825** (Mr. Conable)—To provide for a temporary reduction in duty on imported fresh, chilled, or frozen brussels sprouts. May 10, 1984.
34. **H.R. 4887** (Mr. Vander Jagt)—To permit until January 1, 1987, the duty-free entry of magnetron tubes used in microwave cooking appliances. June 4, 1984.
35. **H.R. 4891** (Mr. Archer)—To provide duty-free treatment to certain cresylic acid. June 22, 1984.
36. **H.R. 4899** (Mr. Frenzel)—To suspend the duty on acetylsulfaguanidine until the close of December 3, 1986. July 6, 1984.
37. **H.R. 5010** (Mr. Pease)—Relating to the tariff treatment of zinc-bearing ores, zinc dross and skinnings, zinc waste and scrap, unwrought zinc, and certain zinc-bearing materials. May 3, 1984.
38. **H.R. 5182** (Mr. Bonker)—To amend the Tariff Schedules of the United States to clarify the duty treatment of certain types of plywood. July 10, 1984.
39. **H.R. 5206** (Mr. Bedell)—To authorize the imposition of additional duties on swine and pork products of Canadian origin in order to offset competitive advantages resulting from any Government subsidy that may be provided to Canadian swine producers. June 15, 1984.
40. **H.R. 5228** (Mr. Gibbons)—To authorize the acceleration of staged rate reductions proclaimed to carry out trade agreements. June 15, 1984.
41. **H.R. 5283** (Mr. Schulze)—To suspend until July 1, 1987, the duty on lacebraiding machines and parts thereof. June 22, 1984.
42. **H.R. 5284** (Mr. Schulze)—To suspend until July 1, 1987, the duty on narrow fabric looms and parts thereof. June 22, 1984.
43. **H.R. 5337** (Mr. Schulze)—To amend the Tariff Schedules of the United States with respect to the tariff treatment accorded to film, strips, and sheets of acrylic plastic materials. June 15, 1984.
44. **H.R. 5338** (Mr. Schulze)—To provide for the temporary suspension of the duty on mixtures of 5-chloro-2-methyl-4-isothiazolin-3-one, 2-methyl-4-isothiazoline-3-one, magnesium chloride, and magnesium nitrate. May 10, 1984.

45. **H.R. 5339** (Mr. Schulze)—To provide for the temporary suspension of the duty on mixtures of potassium 1-(p-chlorophenyl)-1, 4-dihydro-6-methyl-4-oxopyridazine-3-carboxylate ("fenridazon-potassium"), and formulation adjuvants. June 4, 1984.
46. **H.R. 5368** (Mr. Sundquist)—To suspend for a 3-year period the duty on amiodarone. June 15, 1984.
47. **H.R. 5389** (Mr. Vander Jagt)—To temporarily suspend until September 30, 1988, the duty on tetra-aminobiphenyl. May 16, 1984.
48. **H.R. 5410** (Mr. Matsui)—To extend duty-free treatment to scrolls or tablets imported for use in religious observances. June 22, 1984.
49. **H.R. 5422** (Mr. Albosta)—Relating to the tariff classifications of certain silicone resins and materials. July 3, 1984.
50. **H.R. 5429** (Mr. McNulty)—To provide for duty-free entry of articles required for the installation and operation of a telescope in Arizona. July 12, 1984.
51. **H.R. 5436** (Ms. Oakar)—To provide for duty-free entry of an organ imported for the use of Trinity Cathedral of Cleveland, Ohio. June 15, 1984.
52. **H.R. 5448** (Mr. Conable)—To provide duty-free treatment of articles previously imported with respect to which duty was previously paid. June 21, 1984.
53. **H.R. 5453** (Mr. Gibbons)—Authorizing the President to proclaim modifications in the rates of duty for certain articles in trade in civil aircraft. July 20, 1984.
54. **H.R. 5454** (Mr. Glickman)—Extending duty-free treatment to certain tractor parts. June 15, 1984.
55. **H.R. 5455** (Mr. Glickman)—To amend the Tariff Schedules of the United States to clarify the classification of unfinished gasoline. June 22, 1984.
56. **H.R. 5462** (Mr. Livingston)—To amend the Tariff Act of 1930 to provide that certain imports of plywood be permitted free of duty. June 22, 1984.
57. **H.R. 5469** (Mr. Schulze)—To amend the Tariff Schedules of the United States in order to establish equitable duty rates for waterbed mattresses, liners, and parts thereof. June 15, 1984.
58. **H.R. 5524** (Mr. Wolpe)—To provide for the duty-free entry of a ring of eight bells for use of Kalamazoo College, Kalamazoo, MI. October 1, 1984.
59. **H.R. 5535** (Mr. McGrath)—To suspend the duty on certain surface-active agents until the close of June 30, 1986. September 26, 1984.
60. **H.R. 5553** (Mr. Hance)—To suspend the duty on certain benzoid chemicals until the close of June 30, 1986. September 18, 1984.
61. **H.R. 5554** (Mr. Hance)—To suspend the duty on certain nitrogenous chemical compounds until the close of June 30, 1986. September 26, 1984.
62. **H.R. 5562** (Mr. Walgren)—To suspend for a 3-year period the duty on o-benzyl-p-chlorophenol. September 27, 1984.
63. **H.R. 5669** (Mr. Stark)—To increase the column 1 rates of duty on certain structural units of iron or steel, and for other purposes. October 24, 1984.

64. H.R. 5751 (Mr. Gejdenson)—To extend for 2 additional years the suspension of duty on uncompounded allyl resins. July 10, 1984.
65. H.R. 5783 (Ms. Kaptur)—To suspend for a 3-year period the duty on certain metal umbrella frames. July 10, 1984.
66. H.R. 5871 (Mr. AuCoin)—To amend the Tariff Schedules of the United States to increase the duty on certain shelled filberts. August 30, 1984.
67. H.R. 5926 (Mr. Pease)—To amend the Tariff Act of 1930 regarding the public disclosure of certain manifest information. September 25, 1984.
68. H.R. 5991 (Mr. Roe)—To return the ad valorem and specific duties on necktie imports to the levels in effect as of January 1, 1981, for a period of 5 years. September 26, 1984.

Appendix D

Litigation in Fiscal Year 1984

Completed Litigation

Appeals Arising From Antidumping and Countervailing Duty Investigations

Atlantic Sugar, Ltd., et al. v. United States, et al., Appeal No. 84-692 (Court of Appeals for the Federal Circuit).

In this appeal the U.S. Court of Appeals for the Federal Circuit reversed the Court of International Trade's (C.I.T.'s) ruling that overturned the Commission's affirmative injury determination in the Canadian sugar antidumping investigation. The Commission's determination had included the findings that a regional industry existed in the Northeast United States and that this industry was injured by Canadian imports.

The long history of this case included three remands by the Court of International Trade to the Commission, four written decisions by that court, and the ultimate appeal to the Court of Appeals for the Federal Circuit (C.A.F.C.). The first remand was at the request of the Commission to correct certain data in the record. The second remand came as a result of the C.I.T.'s ruling that the Commission was incorrect to aggregate data for all companies in the region. The court held that the law requires the Commission to determine whether each firm is individually injured and then to determine whether the producers of all or almost all of the production in the region are injured.

The Commission thereafter reached a new affirmative determination adhering to the guidelines set by the court. However, the Commissioners restated their position that an aggregate analysis was the appropriate methodology for determining injury. The court again ordered a remand, finding

principally that the Commission should not have considered in its regional analysis the data for one company's plant located outside the region. The Commission's response to this third remand was to note that the company had been unable to provide data that excluded information for the plant outside the region and that use of all the company's data in the regional analysis was therefore appropriate as "the best information available" (19 U.S.C. § 1677e(b)).

In its final decision, the C.I.T. rejected the Commission's "best information available" argument, holding that the statute allows resort to less than ideal information only when a party or person refuses or is unable to produce information or otherwise impedes an investigation. It further held that the data for the Chicago plant were simply irrelevant to a regional analysis and destroyed the usefulness of the company's information and, further, that there was no indication that separate data were truly unavailable. Consequently, the court reversed the Commission's determination.

The decision was appealed to the Court of Appeals for the Federal Circuit, and that court reversed the C.I.T., reinstating the Commission determination and antidumping duty order. The C.A.F.C. rejected the C.I.T.'s view that the "best available information" provision establishes a standard of investigative thoroughness. Moreover, it ruled that the C.I.T. had erred in making assumptions regarding the availability of separate data for the firm's Chicago plant. Finally, the court decided that the Commission's use of the Chicago plant data did not so distort or detract from the evidence in favor of injury as to render the Commission's determination erroneous. In a footnote, the court also rejected the C.I.T.'s decision that the regional industry provision required a company-by-company analysis, noting that its "review of the statute and legislative history indicates no basis for the lower court's holding."

British Steel Corp. v. United States, Case No. 83-7-0140 (Court of International Trade).

This case contested the Commission's final affirmative injury determination in *Stainless Steel Plate From the United Kingdom* (701-TA-196 (Final)). Plaintiffs alleged that the Commission (1) disregarded evidence that imports from the United Kingdom had decreased, finding erroneously that imports had increased since 1981; (2) disregarded evidence showing that on a "cost to the customer" basis, imports from the United Kingdom did not undersell U.S. stainless steel plate; and (3) disregarded information showing that there was no correlation between imports from the United Kingdom and lower U.S. producer prices for stainless steel plate.

On August 6, 1984, Judge Newman of the U.S. Court of International Trade issued an opinion and judgment affirming the Commission's affirmative material injury determination. In the opinion, Judge Newman held that (1) British Steel's argument that the Commission erred by analyzing annual, rather than quarterly, data was without merit; (2) title VII requires the Commission to consider price undercutting by imports, but does not mandate any cost analysis or adjustment of prices for cost factors affecting the subject imports; and (3) British Steel's correlation analysis, allegedly showing no direct correlation between price depression and the volume of British imports, did not necessarily negate causation of injury by reason of those imports, because title VII does not require the imports to be the sole, or even principal, cause of injury, and there was substantial evidence that the volume of imports was a contributing factor to price depression.

Finally, the court rejected British Steel's argument that the determination was not supported by substantial evidence because the Commission failed specifically to address British Steel's principal arguments. The court noted "that it would be helpful to the parties and to the Court if the Commission were to specifically address the main contentions of the

parties," but held that the law makes no requirement that the Commission respond to all arguments presented to it as long as it discloses "the facts and conclusions of law upon which the determination is based."

Roquette Freres and Roquette Corp. v. United States, Case No. 82-5-00636 (Court of International Trade).

In this case, plaintiffs Roquette Freres and Roquette Corp. sought judicial review of the Commission's affirmative determination in *Sorbitol From France* (731-TA-44). The plaintiffs also challenged the determination of the International Trade Administration (ITA) of the Department of Commerce of sales at less than fair value.

Subsequent to plaintiffs' filing of a dispositive motion, certain problems were discovered with regard to the data in the record that might have affected the Commission's determination. Consequently, the Commission filed a motion, which was granted, asking the court to remand the case to it. An investigation on remand was undertaken, and a new determination was issued. In this determination the Commission found that liquid and crystalline sorbitol were separate U.S. industries and determined that there was material injury with regard to crystalline, but not liquid, sorbitol.

Plaintiffs' supplemental brief following the remand determination claimed principally that the Commission committed error because the new determination allegedly was based in part on information that was not in the record and the Commission's staff allegedly engaged in secret, ex parte contacts with the intervenor during the remand investigation.

On March 19, 1984, Judge Boe of the Court of International Trade issued an order and opinion affirming both the Commission and ITA determinations in all respects. His opinion held, among other things, that the Commission's finding of

two separate industries was supported by substantial evidence in the record and that there was no evidence to support plaintiffs' claims that the Commission had relied on off-the-record information and had conducted improper meetings.

Appeals Arising From Investigations Under Section 337 of the Tariff Act of 1930

American Hospital Supply Corp., et al. v. U.S. International Trade Commission, et al., Appeal No. 83-1401 (Court of Appeals for the Federal Circuit).

This was an appeal from the Commission's negative determination in *Certain Amino Acid Formulations* (337-TA-127). The Commission in that investigation found the appellant's patent to be not invalid, but determined that the appellees' competing formulation did not infringe the patent. The court affirmed both findings.

Toho Ganryo Kogyo KK, et al. v. U.S. International Trade Commission, Appeal No. 83-1255 (Court of Appeals for the Federal Circuit).

This case was an appeal from the Commission's affirmative determination in *Certain Silica-Coated Lead Chromate Pigments* (337-TA-120). The appellant sought review of the findings that the appellee's patent was both valid and infringed. In an unpublished opinion, the court agreed with the Commission's reasoning and conclusions and affirmed the determination.

The Young Engineers, Inc. v. USITC, Appeal No. 83-649 (Court of Appeals for the Federal Circuit).

Appellant The Young Engineers, Inc., appealed the Commission's affirmative determination in *Certain Molded-in Sandwich Panel Inserts* (337-TA-99), which resulted in the entry of both exclusion and cease and desist orders. On November 8, 1983, the court unanimously upheld the Commission's determination.

There were two principal issues on appeal: (1) whether, following Presidential disapproval of the original relief granted by the Commission, the Commission was required to institute a new investigation in order to grant different relief on the basis of the unfair acts previously found; and (2) whether the Commission's finding of infringement was barred by the doctrine of res judicata because of the complainant's prior voluntary dismissal with prejudice of a lawsuit involving the same patents.

With regard to the first issue, the court ruled that, under 19 U.S.C. § 337(g)(2), Presidential disapproval does not affect the validity of a Commission determination. Thus, the Commission was justified in treating the case as still pending and issuing an order modifying the initial remedy. On the res judicata issue, the court held that, although the same patent was involved in the Commission investigation as in the prior lawsuit, the infringement issues were different. Since different alleged infringing devices were involved, the Commission was not barred from conducting the investigation.

Appeals Arising From Other Investigative Proceedings

Florsheim Shoe Co. v. United States, Appeal No. 83-1371 (Court of Appeals for the Federal Circuit).

This appeal was a challenge to the President's denial of duty-free treatment under the Generalized System of Preferences to imports of water buffalo leather and goat and kid leather, not fancy, from India, based on a recommendation by the Commission. The Court of International Trade dismissed the case. On appeal to the Court of Appeals for the Federal Circuit, that court affirmed the lower court's action. The court held that Congress had given the President plenary authority over the decision whether to grant or withdraw

duty-free treatment under the GSP, and, therefore, there can be no judicial review of the President's findings of fact and the motivations for his actions. Review can be had only "to determine whether the President's action falls within his delegated authority, whether the statutory language has been properly construed, and whether the President's action conforms with the relevant procedural requirements."

Maple Leaf Fish Co. v. United States, Case No. 81-10-01412 (Court of International Trade).

Plaintiff, an importer of frozen battered and breaded mushrooms, filed a complaint alleging that the Commission and the President acted illegally in finding injury and determining relief for imported articles other than canned mushrooms in a proceeding under section 201 of the Trade Act of 1974. More particularly, the plaintiff challenged the inclusion of frozen battered and breaded mushrooms in the Commission's report to the President on *Mushrooms* (TA-201-43), and Presidential Proclamation No. 4801. The Court of International Trade, in ruling on a motion to dismiss, held that it had subject matter jurisdiction to hear the case under 28 U.S.C. § 1581(a). The court further held, however, that review would be "confined to examining whether the administrative action of the Commission and the President has been exercised in such manner as to conform with the procedural requirement of statutory authority and performed according to law." In a subsequent opinion, the court ruled that under section 201, Congress had delegated to the Commission and the President its legislative authority in this tariff-making matter. "As such, the actions of the ITC and the President are reviewable only to ensure proper construction of the statutory language, compliance with procedural requisites, and whether the scope of delegated authority was exceeded. In the instant matter, the court finds that the ITC and the President acted well within these circumscriptions."

Other Litigation Terminated

In addition to the cases discussed above, a number of cases were ended during fiscal year 1984 without decisions on their merits as a result of dismissal on procedural or jurisdictional grounds or by voluntary dismissal by the plaintiff or appellant. These cases are listed below.

Ashlow, Ltd. v. U.S. International Trade Commission, Appeal Nos. 82-20 and 82-23 (C.A.F.C.).

Carlisle Tire and Rubber Co. v. United States, Case No. 83-6-00881 (C.I.T.).

In re: De La Rue Printrak, Inc., Misc. Docket No. 21 (C.A.F.C.).

In re: Elektroschmelzwerk Kempten GmbH, et al., Misc. Docket No. 28 (C.A.F.C.).

Elektroschmelzwerk Kempten GmbH v. United States International Trade Commission, Appeal No. 84-942.

Fairchild Aircraft Corp. v. United States, Case No. 82-11-01496 (C.I.T.).

Industria Meccanica e Stampaggio, S.p.A. v. United States, Case No. 82-2-00184 (C.I.T.).

Iron and Steel Co. of Trinidad and Tobago, Ltd. v. U.S. International Trade Commission, Case No. 83-12-01787 (C.I.T.).

Matsushita Communication Industrial Co. v. United States, Case No. 83-9-01327 (C.I.T.).

Melamine Chemicals, Inc. v. United States, Case Nos. 80-6-00878, 879, and 880 (C.I.T.).

Motorola, Inc. v. United States, Case No. 83-9-01323 (C.I.T.).

NEC Corp. v. United States, Case No. 83-9-01361 (C.I.T.).

Stevenson v. U.S. International Trade Commission, Appeal No. 84-519 (C.A.F.C.).

Strohmeyer & Arpe Co. v. United States, Case No. 81-10-01393 (C.I.T.).

Ugine Gueugnon v. United States, Case No. 81-10-01119 (C.I.T.).

Pending Litigation At the End of Fiscal Year 1984

Cases arising from antidumping and countervailing duty determinations 35 ¹

Cases arising from section 337 determinations 5

Case arising from section 201 determinations 1

¹All cases filed by different parties challenging the same determination or that have been consolidated by the court are counted only as a single piece of litigation. Thus, the actual number of complaints filed is greater than the number given above.

Appendix E

Statutes Involving the U.S. International Trade Commission

Key Statutes

Sec. 201, Trade Act of 1974 (Escape- Clause Investigations), Import Relief for Domestic Industries

When: The Commission conducts investigations upon its own motion or upon petition on behalf of a firm, a group of workers, or other entity representative of an industry to determine whether an article is being imported in such increased quantities as to be a substantial cause of serious injury, or the threat thereof, to the domestic industry producing an article like or directly competitive with the imported article.

Duration: The investigation must be completed not later than 6 months after being instituted.

Finding: If the Commission's finding is affirmative it must recommend a remedy to the President, who has discretion to take action to provide import relief, such as an increase in duties, the establishment of quantitative restrictions, the negotiation of orderly marketing agreements, or specified types of adjustment assistance to groups of workers, firms, or communities.

Followup: The Commission reports with respect to developments within an industry that has been granted import relief and advises the President of the probable economic effect of the reduction or the elimination of the tariff increase that has been granted.

Sec. 337, Tariff Act of 1930 (Investigations of Unfair Practices in Import Trade)

When: The Commission, after receipt of a complaint under oath from an interested party or upon its own motion, conducts investigations to determine whether unfair methods of competition or unfair acts are occurring in the importation of articles into the United States or in their sale.

Duration: The investigation must be completed in no more than 1 year, or 18 months in a more complicated case, after the date of publication of notice of investigation in the *Federal Register*.

Finding: If the Commission determines that the importation of such articles is such that the effect or tendency is to destroy or substantially injure an efficiently and economically operated industry, or to prevent the establishment of such an industry, or to restrain or monopolize trade and commerce, it may issue orders excluding the articles from entry or issue cease and desist orders. The President may disapprove these actions within 60 days after issuance of the Commission's determination.

Sec. 703(a), Tariff Act of 1930 (Preliminary Counter- vailing Duty Investigations), Subsidized Imports

When: The Commission, after the simultaneous filing of a proper petition with it and the Department of Commerce, conducts investigations to determine, on the basis of the best information available to it at the time of the determination, whether there is a reasonable indication that an industry is materially injured, or is threatened with material injury, or the establishment of an industry is materially retarded, by reason of imports of the allegedly subsidized merchandise that is the subject of the investigation by Commerce.

Duration: The investigation must be completed within 45 days of the receipt of the petition.

Finding: If the Commission's determination is affirmative, Commerce continues its investigation.

*Sec. 705(b), Tariff Act of
1930 (Final Countervailing
Duty Investigations),
Subsidized Imports*

When: The Commission, after a preliminary determination by the Secretary of Commerce that imported articles are subsidized, conducts investigations to determine whether an industry in the United States is materially injured, or is threatened with material injury, or the establishment of an industry in the United States is materially retarded, by reason of imports of the subsidized merchandise.

Duration: The investigation must usually be completed within 120 days after an affirmative preliminary determination by the Secretary of Commerce or 45 days after an affirmative final determination by the Secretary of Commerce that a subsidy is being provided, whichever is longer.

Finding: If the Commission's determination is affirmative, the Secretary of Commerce imposes a countervailing duty on imports of the articles in question.

*Sec. 733(a), Tariff Act of
1930 (Preliminary Antidumping
Investigations),
Imports Marketed
at Less Than Fair Value*

When: The Commission, after the simultaneous filing of a proper petition with it and the Department of Commerce, conducts investigations to determine, on the basis of the best information available to it at the time of the determination, whether there is a reasonable indication

that an industry is materially injured, or is threatened with material injury, or the establishment of an industry is materially retarded, by reason of imports of the allegedly dumped merchandise that is the subject of the investigation by Commerce.

Duration: The investigation must be completed within 45 days of receipt of the petition.

Finding: If the Commission's determination is affirmative, Commerce continues its investigation.

*Sec. 735(b), Tariff Act of
1930 (Final Antidumping
Investigations),
Imports Marketed
at Less Than Fair Value*

When: The Commission, after a preliminary determination by the Secretary of Commerce that imported articles are being, or are likely to be, sold at less than fair value, conducts investigations to determine whether an industry in the United States is materially injured, or is threatened with material injury, or the establishment of an industry in the United States is materially retarded, by reason of imports of the dumped merchandise.

Duration: The investigation must usually be completed within 120 days after an affirmative preliminary determination by the Secretary of Commerce or 45 days after an affirmative final determination by the Secretary of Commerce that the imported articles are being, or are likely to be, sold at less than fair value.

Finding: If the Commission's determination is affirmative, the Secretary of Commerce imposes a dumping duty on imports of the articles in question.

*Sec. 332, Tariff Act of
1930 (General-Purpose
Investigations)*

When: Upon official request or upon its own motion, the Commission initiates a factfinding investigation on any matter involving tariffs and international trade. This broad provision allows the Commission to investigate trade matters of immediate concern to the Government and the public.

Duration: Unless otherwise directed, the Commission establishes an administrative deadline.

Finding: Unless the President or the Congress directs otherwise, the Commission's reports are made available to all interested parties, the general public, the President and executive departments, and the Congress.

*Sec. 22, Agricultural
Adjustment Act,
Import Interference
With Agricultural Programs*

The Commission conducts investigations at the direction of the President to determine whether any articles are being or are practically certain to be imported into the United States under such conditions and in such quantities as to materially interfere with programs of the Department of Agriculture for agricultural commodities or products thereof, or to reduce substantially the amount of any product processed in the United States from such commodities or products, and makes findings and recommendations to the President. The President may restrict the imports in question by imposition of either import fees or quotas.

*Other Areas of
Involvement by Statute*

*Bestowal of Bounties
or Grants on Imports*

The Commission determines, with respect to any duty-free article on which the Secretary of Commerce has determined that a bounty or grant is being paid, whether an industry in the United States is being or is likely to be injured, or is prevented from being established, by reason of the importation of such article. (Sec. 303, Tariff Act of 1930, 46 Stat. 687.)

Uniform Statistical Data

The Commission, in cooperation with the Secretary of the Treasury and the Secretary of Commerce, establishes for statistical purposes an enumeration of articles imported into the United States and exported from the United States, and seeks to establish comparability of such statistics with statistical programs for domestic production. (Sec. 484(e), Tariff Act of 1930, 19 U.S.C. 1484(e).)

*Tariff Schedules
of the United States
Annotated*

The Commission issues a publication containing U.S. tariff schedules and related material and considers questions concerning the arrangement of such schedules and the classification of articles. (Sec. 201, Tariff Classification Act of 1962, 76 Stat. 74; secs. 332(a) and 484(e), Tariff Act of 1930, 19 U.S.C. 1332(a) and 19 U.S.C. 1484(e).)

Tariff Summaries

The Commission prepares and publishes, from time to time, a series of summaries of trade and tariff information. These summaries contain descriptions (in terms of the Tariff Schedules of the United States) of the thousands of products imported into the United States, methods of production, and the extent and relative importance of U.S. consumption, production, and trade, together with certain basic factors affecting the competitive position and economic health of domestic industries. (Sec. 332, Tariff Act of 1930, 19 U.S.C. 1332.)

Annual Report on the U.S. Trade Agreements Program

The Commission prepares for the Congress and the interested public a "factual report on the operation of the trade agreements program." The report contains information on U.S. participation in multilateral trade negotiations and agreements, as well as related material on foreign economic and trade developments and the administration of U.S. trade laws. (Sec. 163(b), Trade Act of 1974, 19 U.S.C. 2213.)

Advice Concerning Trade Negotiations

The Commission advises the President as to the probable economic effect on domestic industries and consumers of modification of duties and other barriers to trade that may be considered for inclusion in any proposed trade agreement with foreign countries. (Sec. 131, Trade Act of 1974, 19 U.S.C. 2151.)

Generalized System of Preferences

With respect to articles that may be considered for duty-free treatment when imported from designated developing countries, the Commission advises the President as to the probable economic effect of the removal of duty on the domestic industry and on consumers. (Secs. 131 and 503, Trade Act of 1974, 19 U.S.C. 2151, 2163.)

East-West Trade Monitoring System

The Commission monitors imports into the United States from nonmarket economy countries and makes a report not less frequently than once each calendar quarter on the effect of such imports on the production of like or directly competitive articles in the United States and on employment within the industry. (Sec. 410, Trade Act of 1974, 19 U.S.C. 2440.)

Trade With Communist Countries

The Commission makes investigations to determine whether increased imports of an article produced in a Communist country are causing market disruption in the United States. If the Commission's determination is in the affirmative, the President may take the same action as in a case involving injury to an industry, except that the action would apply only to imports of the article from the Communist country. (Sec. 406, Trade Act of 1974, 19 U.S.C. 2436.)